

INDOOR / OUTDOOR

# Retractable Gate

Instruction Manual

INSTALLATION VIDEO



Proud  
Supporter

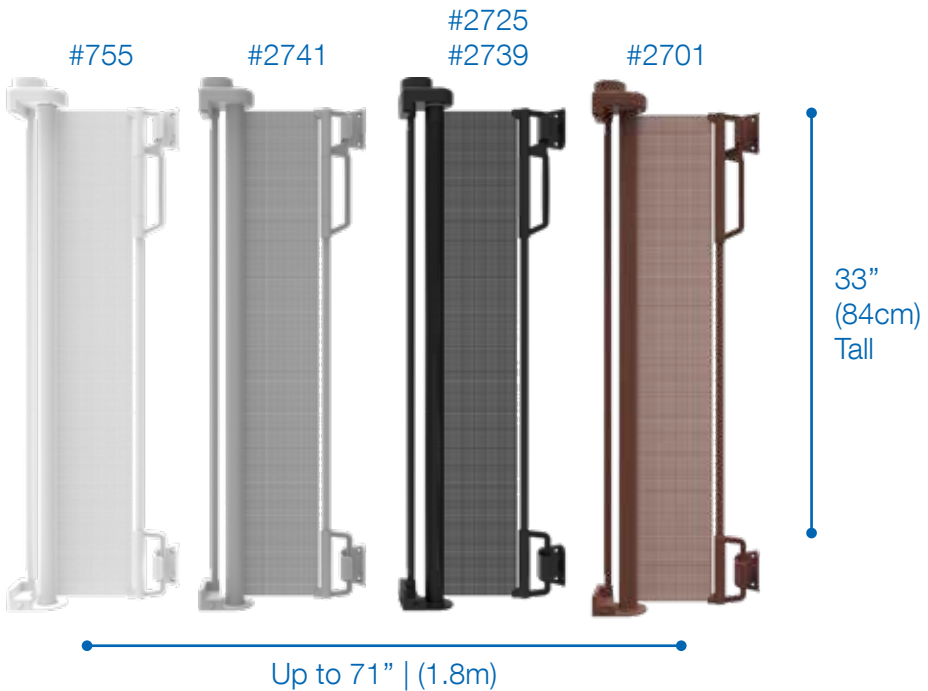

**IMPORTANT! READ AND FOLLOW THESE INSTRUCTIONS CAREFULLY AND KEEP FOR FUTURE REFERENCE.**

This product complies with safety standard ASTM F1004 - 10.

# TABLE OF CONTENTS

---

<b>SAFETY INFORMATION</b>	
General	03
Maintenance	03
Warnings	04
Mountings	06
<b>WHAT'S IN THE BOX</b>	
Parts	08
<b>INSTALLATION</b>	
Gate Placement	10
Inside Opening or Doorway	11
Outside Opening or Doorway	15
With Skirting or Baseboard	16
To Remove	17
<b>OPERATION</b>	
How to Open	18
Cleaning Instructions	19
<b>SUPPORT</b>	
Warranty Certificate	20
Warranty Card	21
After Sales Support	21

# SAFETY INFORMATION

---

## GENERAL

Read this instruction manual carefully and keep it in a safe place for future reference. The correct use and maintenance of this product is essential.

## MAINTENANCE

Regularly check that the gate is functioning correctly, lubricate hinges and moving components with a suitable spray lubricant. Tighten and adjust mounts to ensure secure smooth operation. Inspect all components regularly and stop using if any component is damaged or missing.

# WARNINGS

- WARNING** To prevent serious injury or death, securely install gate or enclosure and use according to manufacturer's instructions.
- WARNING** Incorrect installation can be dangerous.
- WARNING** Danger to older children if climbing over the product.
- WARNING** Do not use the safety barrier if any components are damaged or missing.
- WARNING** The safety barrier must not be fitted across windows.
- WARNING** Never install this product on glass doors. Install this product against reliable doors or walls.
- WARNING** If the safety barrier is used at the top of the stairs, it should not be positioned below the top level.
- WARNING** If the safety barrier is used at the bottom of the stairs, it should be positioned at the front of the lowest tread possible.
- WARNING** This safety barrier is for domestic use only.
- WARNING** This safety barrier has a manual closing system.
- WARNING** Never leave the child unattended when using this product.
- WARNING** Children have died or been seriously injured when gates/enclosures are not securely installed.

# WARNINGS

- WARNING** Always check that the safety barrier is correctly closed.
- WARNING** Use only with the locking/latching mechanism securely engaged.
- WARNING** Gate must be installed as close to the ground as possible, as per the installation guides.
- WARNING** Never use with a child able to climb over or dislodge/open the gate or enclosure.
- WARNING** Regularly check that the safety barrier is properly installed and secure.
- WARNING** Always install and use as directed using all parts. Any additional or replacement parts should be obtained from after sales support.
- WARNING** Barrier must be fitted between rigid surfaces such as plaster board, timber or hard wall.
- WARNING** This product is intended for use with children from 6 to 24 months or small to medium pets from 4.5kg (10 lbs) up to 18kg (40 lbs).
- WARNING** Do not put any goods which can be grabbed by children or pets near this product to prevent injury.
- WARNING** Before using this product, carefully inspect for any loose parts and whether any parts need to be tightened.
- WARNING** Never use to keep child away from pool.

# MOUNTINGS

Gate must be installed in a structurally sound opening. Ensure mounting surface (wall, door frame, stair posts, etc.) is strong, rigid and has an even surface.

**Note:** If using gate on stairs, it must be placed either on the top step or on the lowest step at the bottom.

Select the appropriate fixing method from the following list.



## WOOD MOUNTING

Drill 5/64" (2mm) pilot holes and use the wood screws provided screwing directly into the wood.



## FOR INSTALLATION

Wood Screws

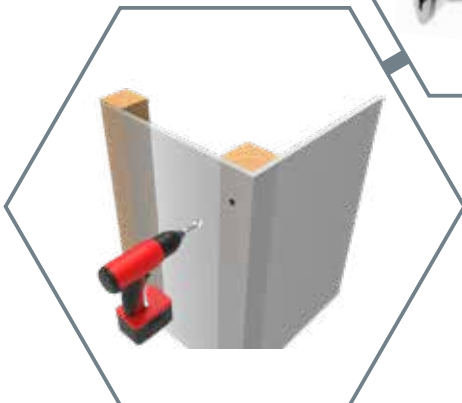

## DRY WALL MOUNTING

Locate the wood stud and follow the wood mounting instructions. **Do not mount into dry wall without additional support.**

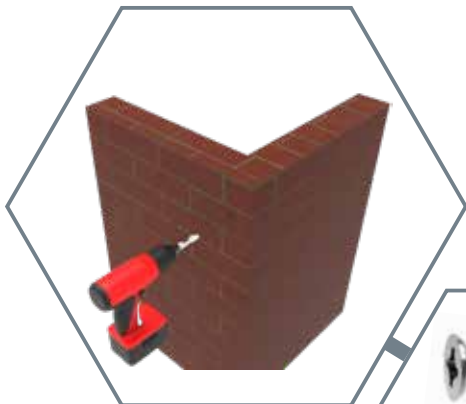

## HARD WALL MOUNTING BRICK

Drill 5mm (3/16") pilot holes,  
insert anchor and secure with  
screws.



## FOR INSTALLATION

Wood Screws  
Anchor

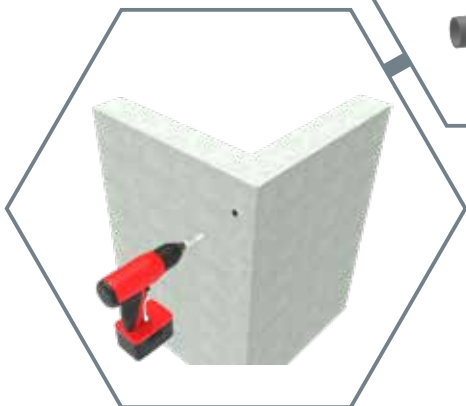

## HARD WALL MOUNTING CONCRETE

Drill 3/16" (5mm) pilot holes,  
insert anchor and secure  
with screws.

## TOOLS REQUIRED



PENCIL



PHILLIPS HEAD  
SCREW DRIVER



DRILL

This gate must only be fixed to a solid and secure surface. If unsure, check with a qualified builder or trades person that the installation you intend is suitable and safe within the chosen location.

# PARTS

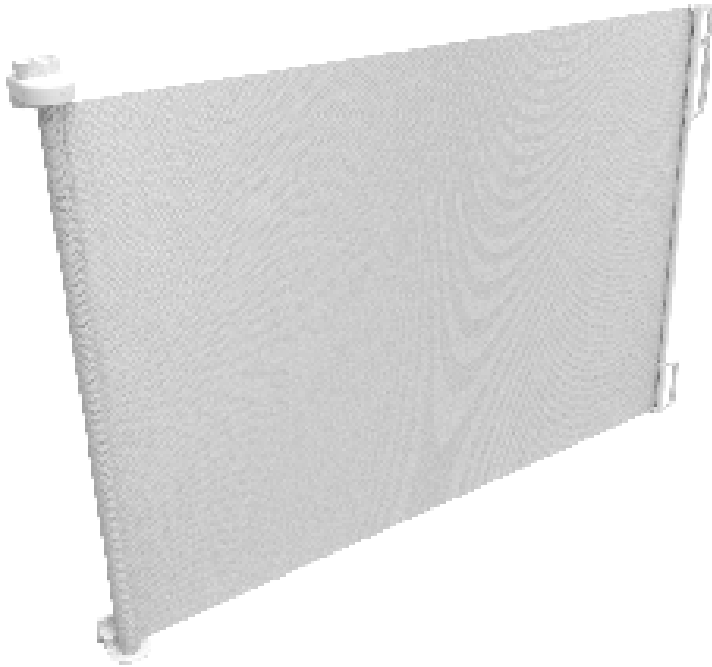

**1 x**  
Gate Assembly

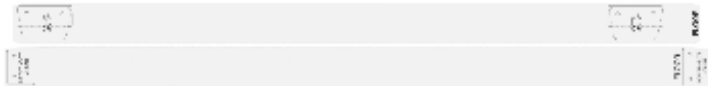

**1 x** Gate Mount Installation Guide

**1 x** Catch Mount Installation Guide





**1 x**

Upper Gate Mount



**1 x**

Lower Gate Mount

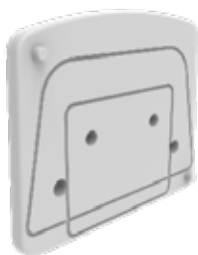

**6 x**

Wall Spacers



**2 x**

Catch Mounts



**8 x**

Wall Plugs

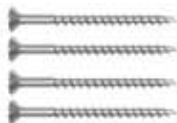

**4 x** 35mm (1 3/8")  
Upper Mount Screws  
(use with spacers)



**4 x**  
25mm (1") Lower  
Mount Screws

# STEP 1: GATE PLACEMENT

## SUITABLE PLACEMENT OF GATE AND CATCH MOUNT

### Inside Opening or Doorway

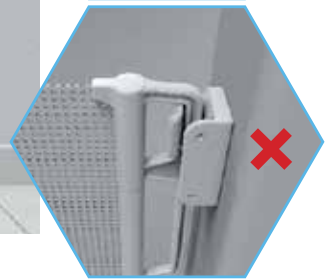
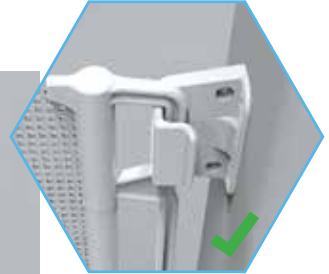

### Outside Opening or Doorway

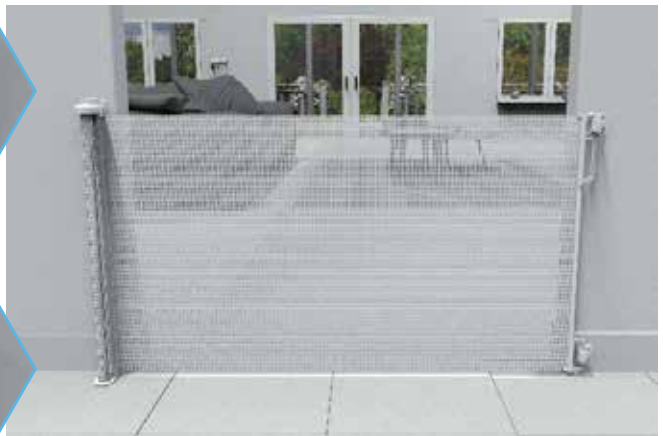
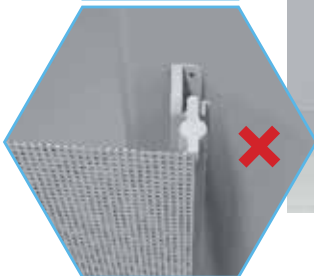
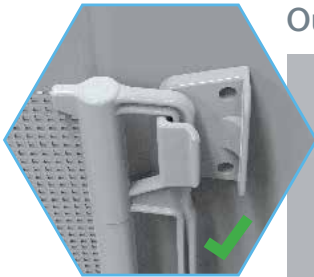

# STEP 2: INSIDE OPENING OR DOORWAY

1. Use the Gate Mount Installation Guide for the side you want the gate to retract from. Hold it vertically and completely outstretched against mounting surface with the end marked “FLOOR” even with the floor. Mark screw hole positions. Remove the template.

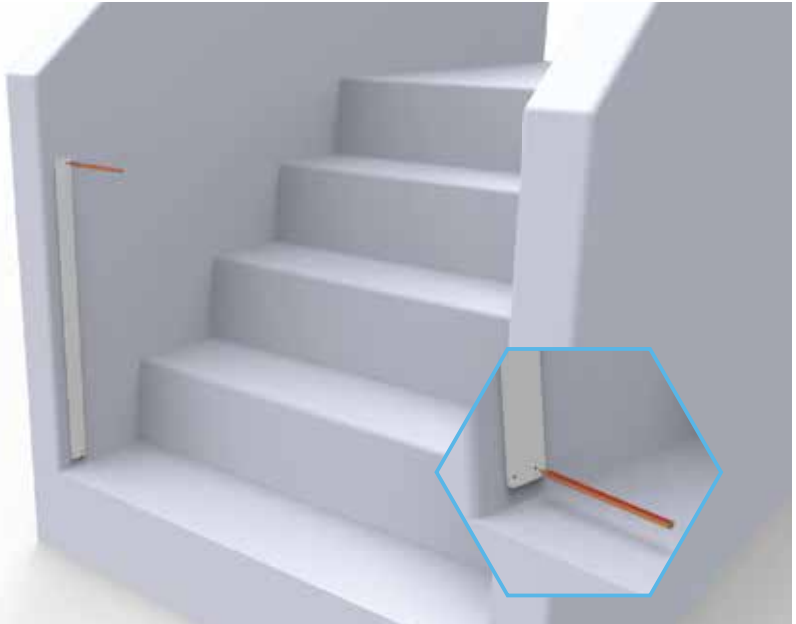

Note: leave at least 3/4” (2cm) between Guide and the edge of the opening to ensure gate won’t overhang edge.

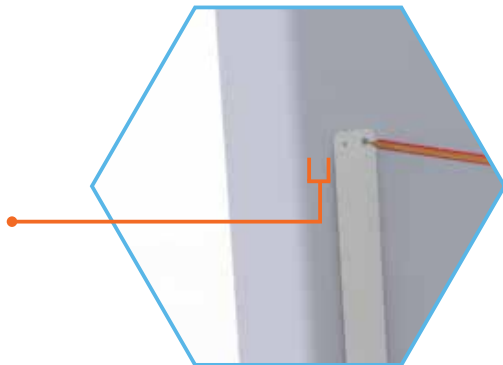

2. Repeat Step 1 for the other side with the Catch Mount Installation Guide.



3. Align the Upper & Lower Gate Mount on the side you want the gate to retract from. Use a Phillips screwdriver to tighten Screws until each mount is secure.

4. Align the Catch Mount in its correct position on the side you want the gate to retract to, use a Phillips screwdriver to tighten Screws until each Mount is secure.

NOTE: Ensure correct installation of Catch Mount.

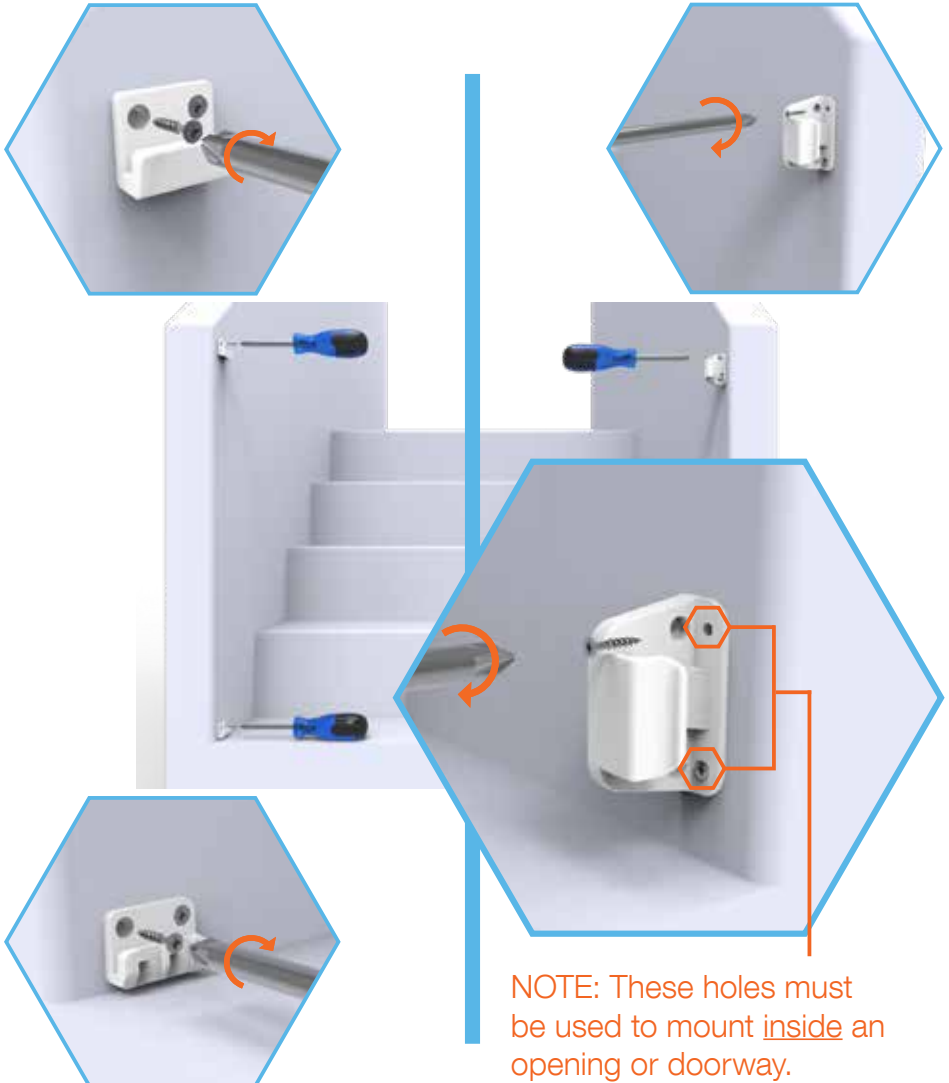

5. Attach Gate Assembly to the Gate Mounts by aligning the gate directly above and sliding straight down over Mounts. Check that the Gate Assembly is flush against the wall and is locked firmly in place.

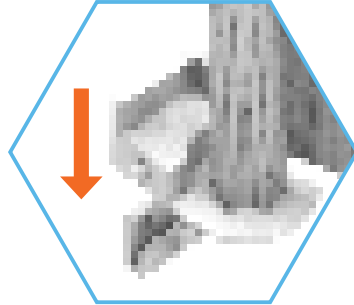
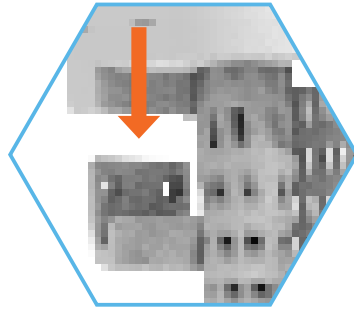
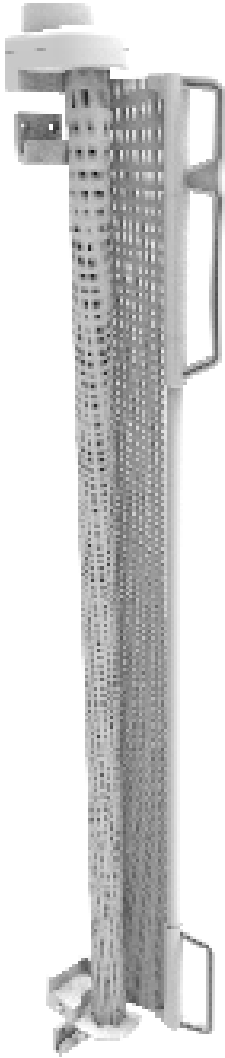

NOTE: Lower Gate Mount has a locking groove.

# STEP 3: OUTSIDE OPENING OR DOORWAY

1. Follow step 1 & 2 from “Installation Inside Doorway or Opening” on page 11 & 12.
2. Align each mount in its correct position, use a Phillips screwdriver to tighten Screws until each mount is secure.

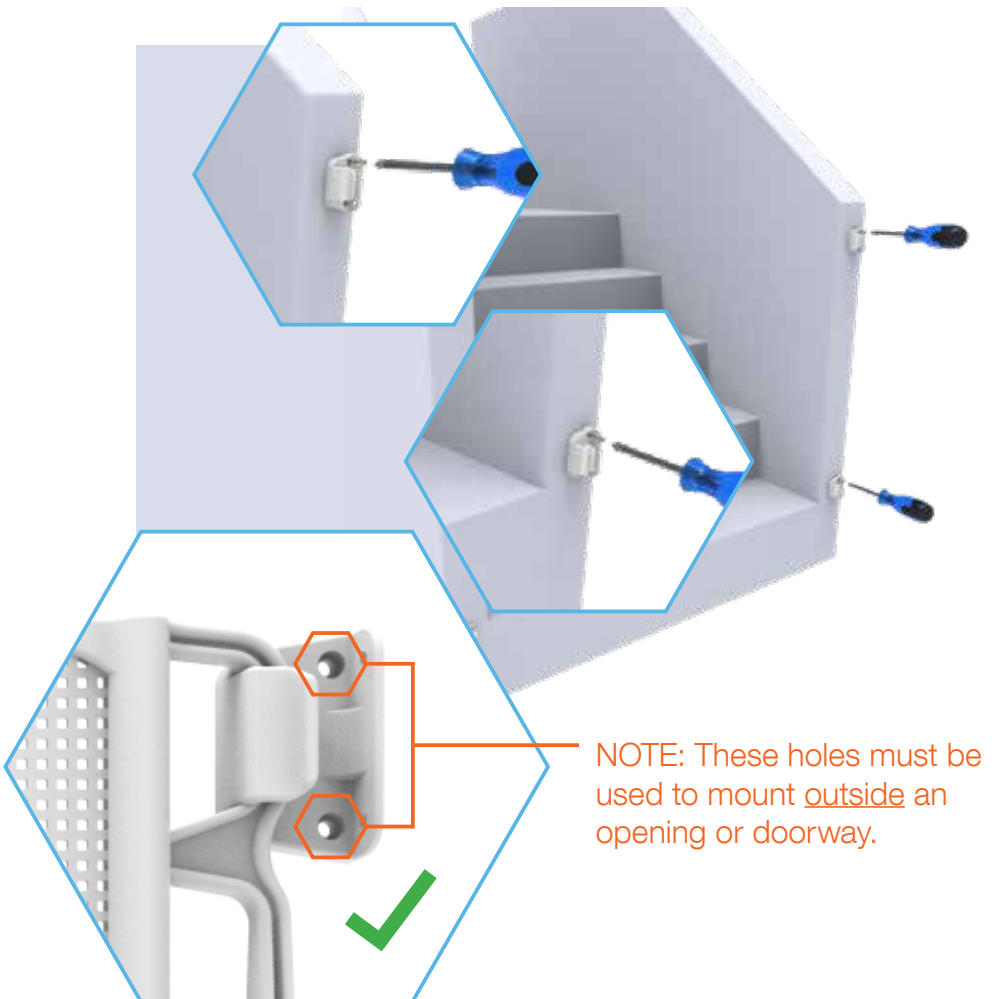

## STEP 4: WITH SKIRTING OR BASEBOARD

To help correct for the offset of a skirting board or baseboard, Spacers will be required. Measure the width of your skirting/baseboard and use the closest number of Spacers to fit this width. Each Spacer is 3/16" (5mm) thick.



Note: Only use Spacers for the Upper Gate Mount and the Upper Catch Mount.

Follow step 1 & 2 from “Installation Inside Doorway or Opening”, align Spacers and Mounts in their correct position, use a Phillips screwdriver to tighten Screws until each Mount is secure.

**Additional wall Spacers are available from after sales support.**



# STEP 4: TO REMOVE

1. To remove gate from the Mounts, push and hold the release button while sliding the gate upwards.

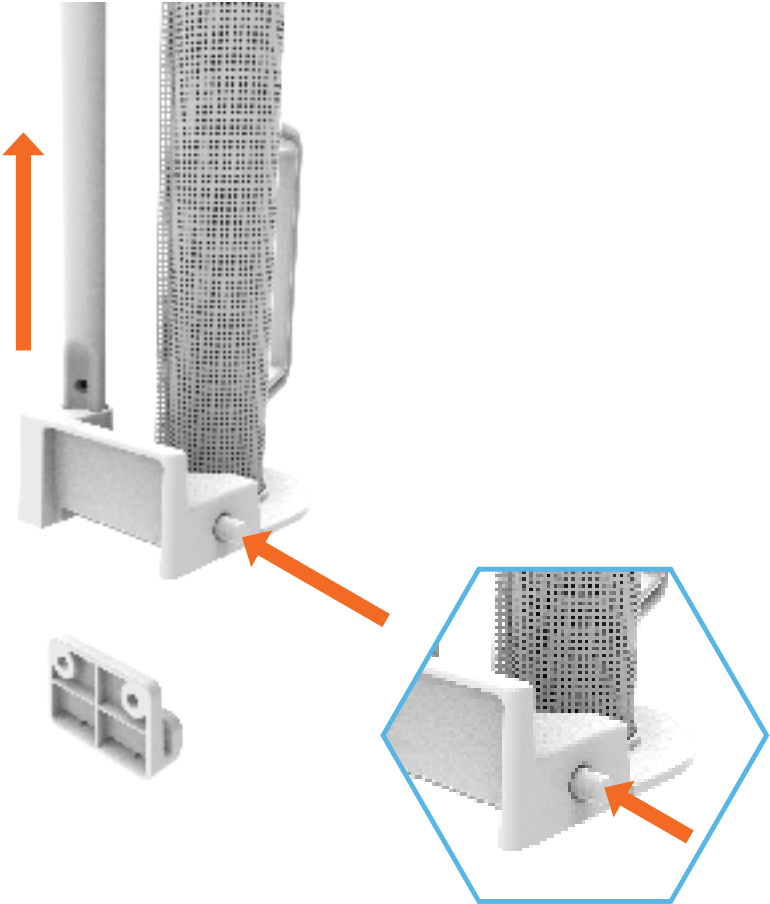

# HOW TO OPEN



ONE-HANDED  
OPERATION VIDEO



1. To unlock the mechanism, simply push down and turn the button clockwise.

2. There is no need to continue to hold the button to release the gate, pull handle in one fluid movement as stopping will engage lock.



3. Pull handle and hook onto catches.



Note: When gate is retracting always hold the handle and guide the gate evenly back into its original position. Never let go of handle when gate is retracting.

# CLEANING INSTRUCTIONS

Simply use a soft damp cloth to wipe gate, dry after cleaning.  
Do not use chemical or abrasive cleaners.

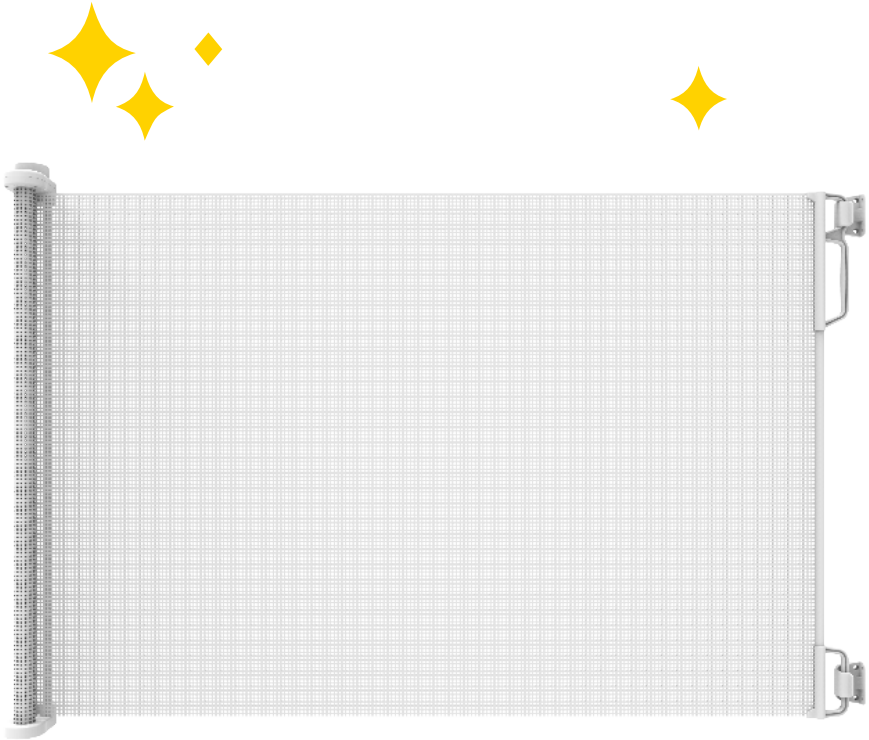

# WARRANTY CERTIFICATE

Congratulations! You have made an excellent choice of this quality product. Our commitment to quality also includes our service. Should you, contrary to expectations, experience defects due to manufacturing faults, we will provide you with a warranty against defects as follows:

## Warranty

The product is guaranteed to be free from defects in workmanship and parts for a period of 12 months from the date of purchase. Defects that occur within this warranty period, under normal use and care, will be repaired, replaced or refunded at our discretion. You are entitled to a replacement or refund for a major failure and for compensation for any other reasonably foreseeable loss or damage. You are also entitled to have the goods repaired or replaced if the goods fail to be of acceptable quality and the failure does not amount to a major failure.

## Proof of Purchase

This warranty is valid for the original purchase and is not transferable. Please keep your purchase docket, tax invoice or receipt as the best proof of purchase, and as proof of date on which the purchase was made.

## Extent of Warranty

This warranty is limited to defects in workmanship or parts. All defective products or parts will be repaired or replaced. This warranty does not cover consumable items.

## Normal Wear and Tear

This warranty does not cover normal wear and tear to the products or parts.

## Exclusions

This warranty does not cover:

- Any defects caused by an accident, misuse, abuse, improper installation or operation, lack of reasonable care, unauthorised modification, loss of parts, tampering or attempted repair by a person not authorised by the distributor.
- Any product that has not been installed, operated or maintained in accordance with the manufacturer's operating instructions provided with the product.
- Any product that has been used for purposes other than domestic use.

## To Make a Claim

If a defect in the goods appears within 12 months, you are entitled to claim a warranty. Please contact after sales support via the link below:

[www.permachildsafety.com/contact-us](http://www.permachildsafety.com/contact-us)

Please ensure that you have a copy of proof of purchase so that we are able to respond as quickly and efficiently as possible.

# WARRANTY CARD

## Details:

**Product Name:** Indoor/Outdoor Retractable Gate

**Product Number:** White 755 / Grey 2741 / Black 2725 2739 / Timber 2701

**Your Name:**

**Address:**

**Phone:**

**Email:**

**Date of Purchase:**

**Location of Purchase:**

We recommend that you keep a copy of your receipt, showing the date of purchase, with this warranty certificate and keep for your reference. In the event of a product fault, please contact after sales support. Ensure that you include the product details (as shown on this card) so that we are able to respond as quickly and efficiently as possible.

## AFTER SALES SUPPORT

**Product Code:** White 755, Grey 2741, Black 2725 2739, Timber 2701



For questions, concerns and to view our latest products visit:  
[www.permachildsafety.com/contact-us](http://www.permachildsafety.com/contact-us)



©2020 Permastik Pty Ltd.  
All Rights Reserved.  
Distributed by Perma Products USA®  
[www.permaproducts.com](http://www.permaproducts.com)  
Tel: 239 494 5481  
Made in China to Perma quality standards



CARDBOARD BOX  
PLEASE RECYCLE