



Proud
Supporter



3-In-1 Playpen/Barrier

INSTRUCTION MANUAL

73cm - 370cm
(28.8" - 144.6")
FITS OPENINGS

75cm
(29.5")
TALL

#2747 White
#2752 Warm Black

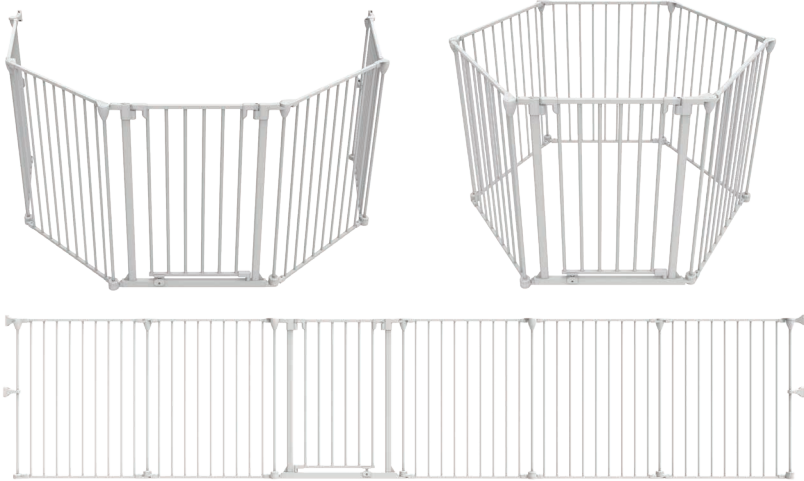

**IMPORTANT! READ AND FOLLOW
THESE INSTRUCTIONS
CAREFULLY AND KEEP
FOR FUTURE REFERENCE.**

TABLE OF CONTENTS

SAFETY INFORMATION

General	03
Maintenance	03
Warnings	04-05
Mountings / Tools Required	06-07

WHAT'S IN THE BOX

Parts	08-09
-------	-------

INSTALLATION

Playpen/Barrier Placement & Configuration	10
Underside Bracket Wall Assembly	11-13
Topside Bracket Wall Assembly	14
To Add / To Remove Panels	15
Playpen Assembly	16
Safety Play Mat	17
Spare Parts & Accessories	17

OPERATION

How to Open	18
Cleaning Instructions	19

SUPPORT

Warranty Certificate	20
Warranty Card	21
After Sales Support	21

SAFETY INFORMATION

GENERAL

Read this instruction manual carefully and keep it in a safe place for future reference.

The correct use and maintenance of this product is essential.

MAINTENANCE

Regularly check that the product is functioning correctly, lubricate hinges and moving components. Tighten and adjust mounts to ensure secure smooth operation. Inspect all components regularly and stop using if any component is damaged or missing.

Refer to pages 18 & 19 for operation and cleaning instructions.

WARNING

WHEN USED AS SAFETY BARRIER

- Incorrect fitting or positioning of this safety barrier can be dangerous.
- Do not use the safety barrier if any components are damaged, missing or disassembled.
- Never install this product on glass doors or windows.
- Stop using the product if the child is able to climb, dislodge or open barrier unassisted.
- A maximum of 9 panels can be used when used as a barrier/room divider.
- Danger to older children if climbing over the barrier.
- Regularly check that the barrier is properly fixed and secure.
- Any additional or replacement parts should only be obtained from after sales support.
- This safety gate is suitable for openings from 73cm (28.8") to 370cm (145.6").
- Before using this product, carefully inspect for any loose parts and whether any parts need to be tightened.
- Children have died or been seriously injured when gates/enclosures are not securely installed.
- ALWAYS install and use gates/enclosures as directed using all required parts.



WARNING

WHEN USED AS PLAYPEN

- This product is intended for use with children from 6 to 24 months or small to medium pets from 4.5kg (10 lbs) up to 18kg (40 lbs).
- Do not use the playpen without the Perma Products play mat base.
- Do not place the playpen close to an open fire or other heat source.
- Do not leave anything in the playpen which may provide a foothold or create a danger of suffocation or strangulation.
- This safety barrier is for domestic use only.
- This safety barrier has a manual closing system.
- Ensure that the playpen is fully erected and all the locking mechanisms engaged before placing your child in this playpen.
- Do not use the playpen if any part is broken, torn or missing and use only spare parts approved by manufacturer, accessories which are not approved by manufacturer shall not be used.
- Check regularly that all assembly fittings are tightened properly.
- Use only with the locking/latching mechanism securely engaged.
- NEVER use to keep child away from pool.

SAFETY INFORMATION

MOUNTINGS

Gate must be installed in a structurally sound opening. Ensure mounting surface (wall, door, stair posts, etc.) is strong, rigid and has an even surface.

Note: If the safety barrier is used at the top of the stairs, it should not be positioned below the top level. If the safety barrier is used at the bottom of the stairs, it should be positioned at the front of the lowest tread possible.

This gate must only be fixed to a solid and secure surface. If unsure, check with a qualified builder or trades person that the installation you intend is suitable and safe within the chosen location.

TOOLS REQUIRED



PENCIL



PHILLIPS HEAD
SCREW DRIVER



DRILL

SAFETY INFORMATION

Select the appropriate fixing method from the list below.

HARD WALL MOUNTING BRICK / CONCRETE



FOR INSTALLATION

Wood Screws
Anchor

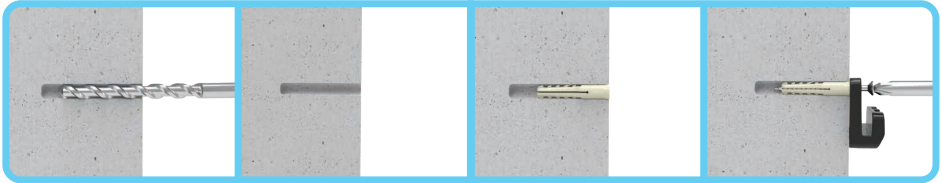

1. Drill 5mm (3/16")
Pilot Hole

2. Clear Hole

3. Insert Anchor & Tap

4. Tighten slowly

WOOD MOUNTING



FOR INSTALLATION

Wood Screws

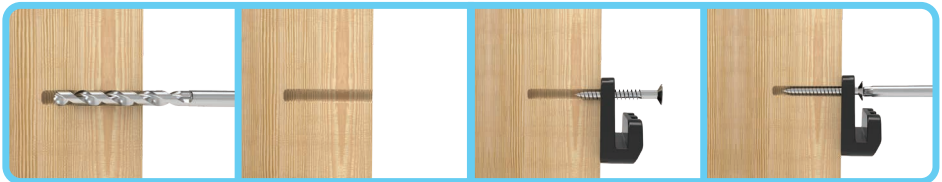

1. Drill 2mm (5/65")
Pilot Hole

2. Clear Hole

3. Insert Screw

4. Tighten slowly

DRY WALL MOUNTING

Locate the wood stud and follow the wood mounting instructions.

Do not mount into dry wall without additional support.

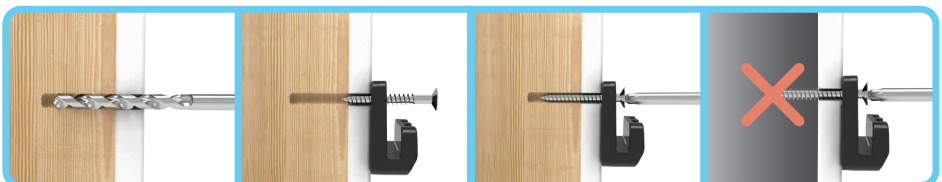

1. Drill 2mm (3/32")
Pilot Hole

2. Insert Screw

3. Tighten slowly

Do not mount without
additional support

WHAT'S IN THE BOX

PARTS



5 x Barrier Panels



1 x Gate Panel

WHAT'S IN THE BOX

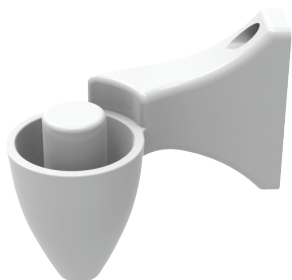

1 x Top Underside
Wall Bracket



1 x Top Topside
Wall Bracket



2 x Lower
Wall Bracket



1 x Top Cap

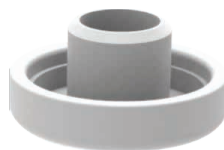

1 x Bottom Cap



8 x Anchors



8x 25mm (1")
Screws



7 x Corner Tubes

INSTALLATION

Playpen/Barrier Placement & Configuration

Suitable placement & Configuration of Playpen/Barrier



CAUTION: Install Barrier a minimum of 60cm (25.5") away from fireplace.

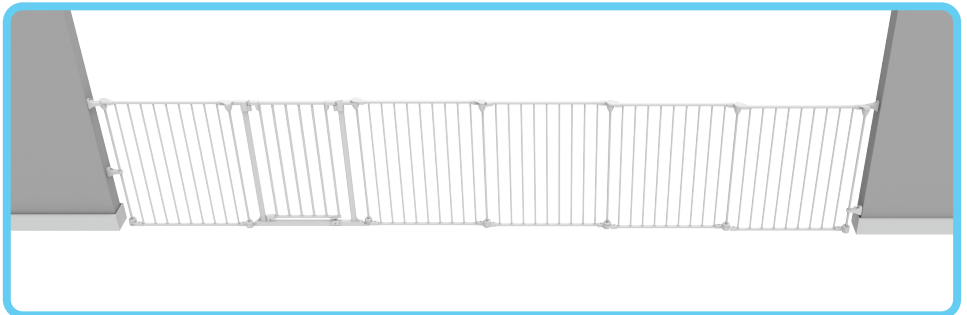
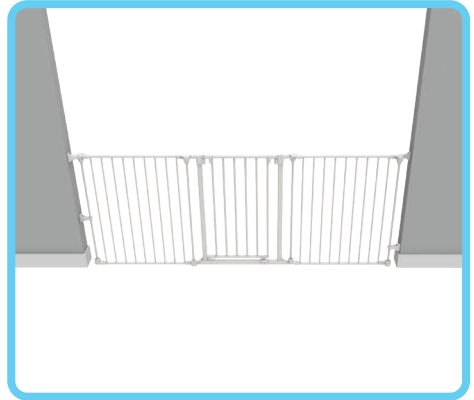
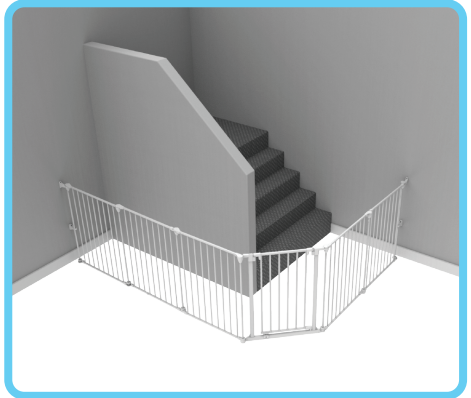

INSTALLATION

Step 1. Underside Bracket Wall Assembly

Place the Lower Wall Bracket over Corner Tube and put the Corner Tube into the Top Underside Wall Bracket. Put the Top Underside Wall Bracket into the top of the Barrier Panel and the bottom of the Corner Tube into the Top Cap on the bottom of the Barrier Panel, then into the Bottom Cap.



INSTALLATION

Step 2.

Mark screw hole positions for the Top Underside Wall Bracket and Lower Wall Bracket. Disassemble Corner Tube and Barrier Panel from Top Underside Wall Bracket and Lower Wall Bracket. Screw in Top Underside Wall Bracket and Lower Wall Bracket.

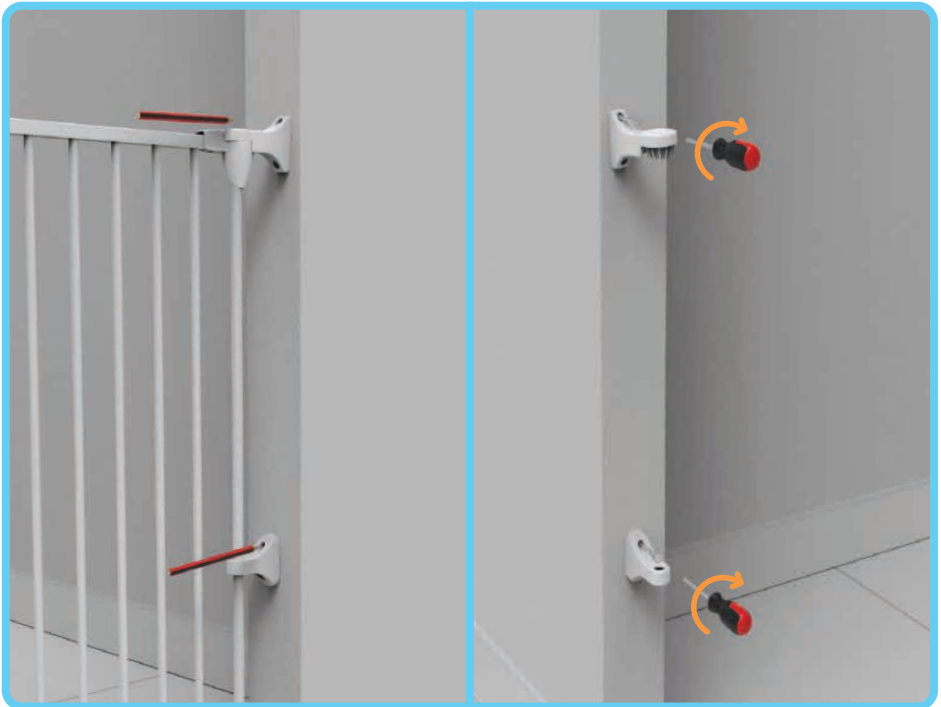

NOTE: Install Wall Brackets on an even surface to ensure Playpen/ Barrier is secure.

INSTALLATION

Step 3.

Reassemble Barrier Panel by connecting to the Top Underside Wall Bracket. Place Corner Tube through the Lower Wall Bracket, pull Corner Tube up and slide into the Top Underside Wall Bracket. Then place Corner Tube down into the Top Cap on the bottom of the Barrier Panel.

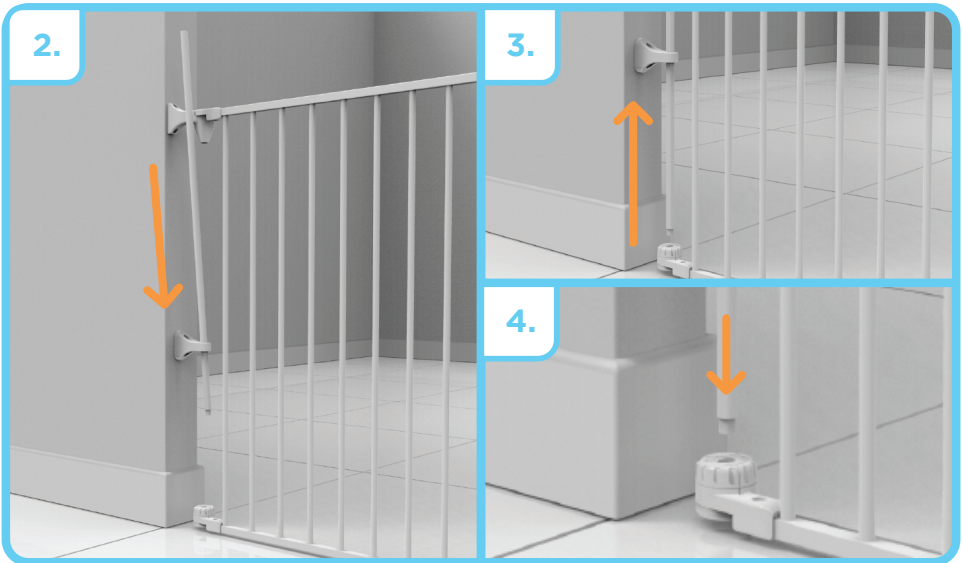
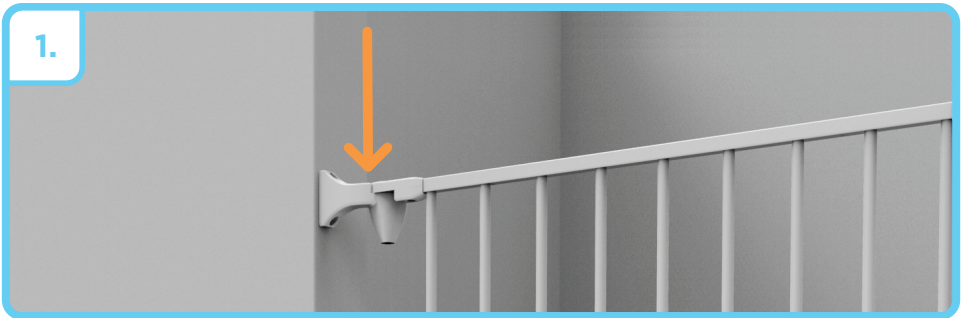

INSTALLATION

Step 4. Topside Bracket Wall Assembly

Place the Lower Wall Bracket over Corner Tube and slide Corner Tube up into the Barrier Panel and then into the Top Topside Wall Bracket. Follow Step 2 from Page 12 to mark position. Then reassemble and put the Top Cap on the bottom of the Barrier Panel and slide Corner Tube down into the Top Cap.

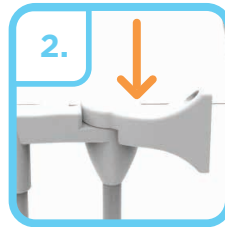
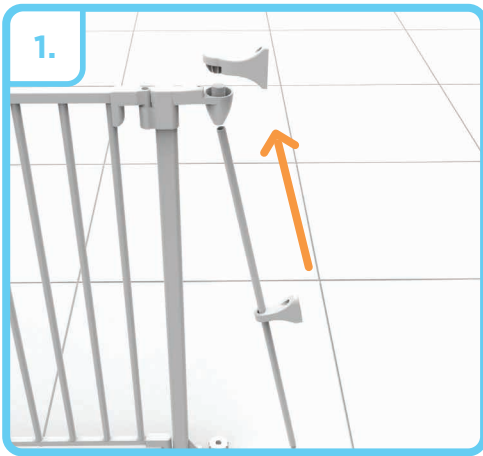

NOTE: Follow Step 2 from Page 12 to mark position of wall brackets before proceeding below.

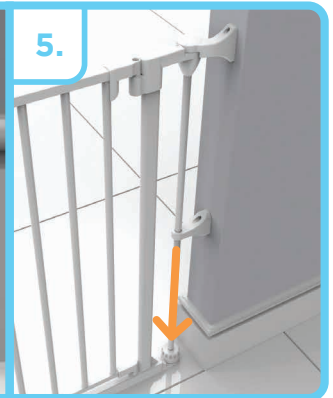
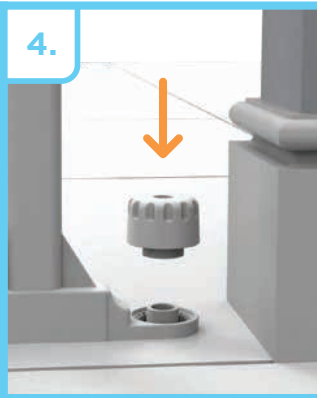

INSTALLATION

To Add Extra Panels

Align opposite ends of panels, place the Corner Tube into the top hole first, then pull the Corner Tube up and place the bottom of the Corner Tube into the Top Cap hole on the bottom of the Barrier Panel.

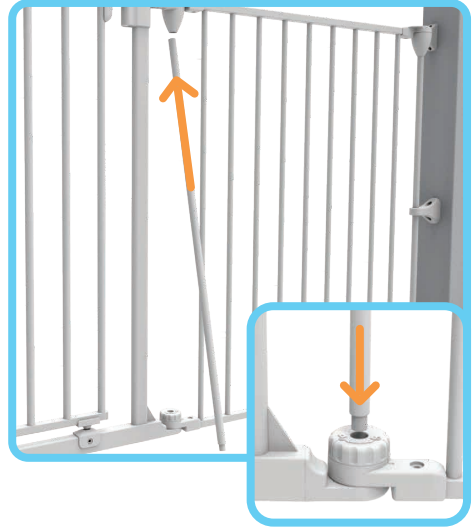

To Remove Panels

Turn base knob to unlocked position. Pull up the Corner Tube and slide the bottom of the Corner Tube out from the base. Once the Corner Tube is removed, you can lift and remove the unwanted panel.

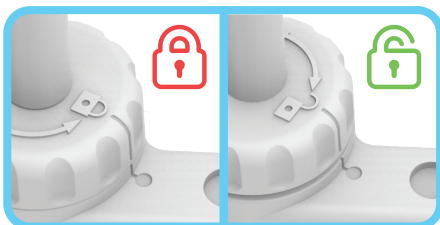
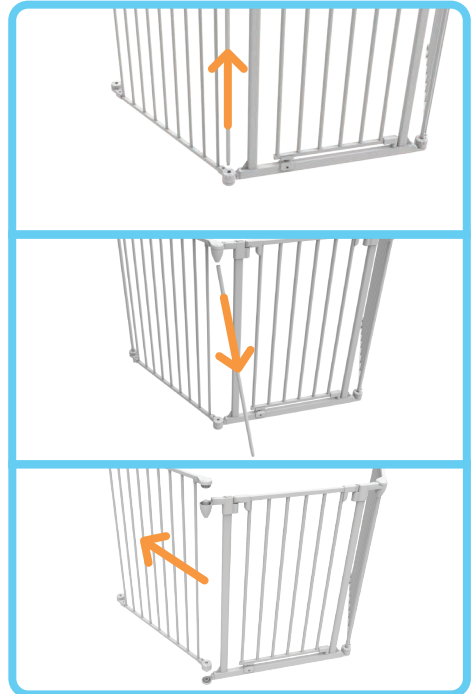

INSTALLATION

Playpen Assembly

1. Align the Gate Panel and Barrier Panel together. Place the Corner Tube into the top hole first, then pull the Corner Tube up and place the bottom of the Corner Tube into the Top Cap hole on the bottom of the Barrier Panel. Align arrow with hexagon icon.



2. Repeat previous step with remaining Panels and Corner Tubes until all sides are connected, then turn base knob and align lock icon with dot on panel to unlock.

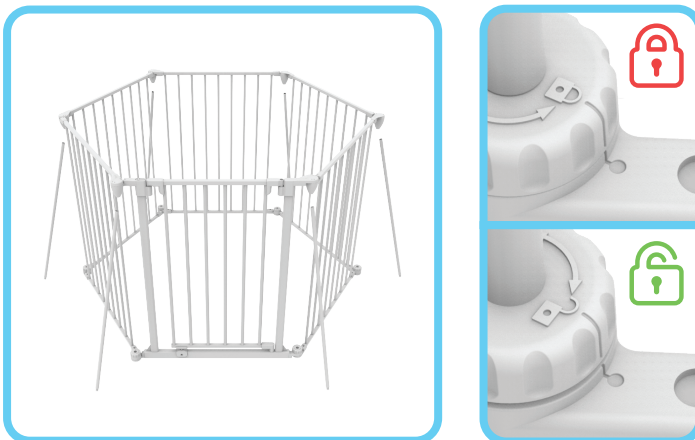

INSTALLATION

Safety Play Mat

Note: A safety play mat is required if playpen is used with children. The play mat is sold separately, contact after sales support for more details.

The play mat can now be placed into the playpen and secured to the bottom bars of each panel with the ties.

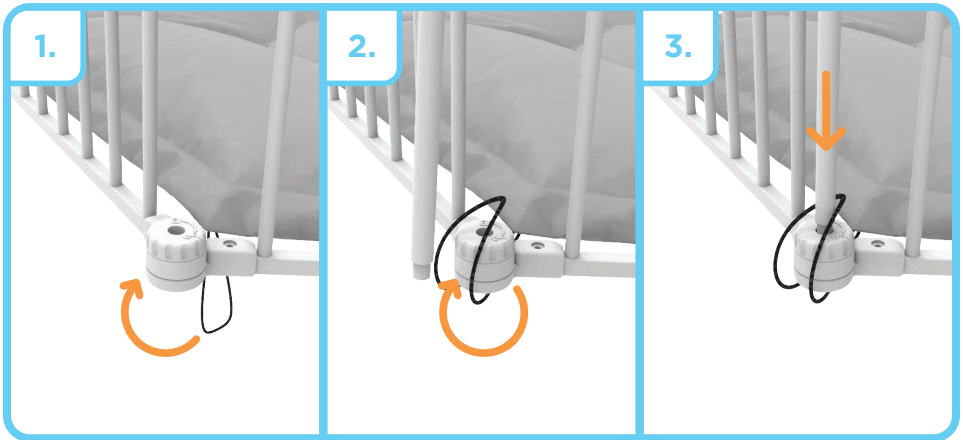

Spare Parts & Accessories

Scan the QR Code to view the full range of Spare Parts & Accessories including; Additional Panels, Additional Gates, Stability Clips and Wall Mounting Sets.



OPERATION

HOW TO OPEN

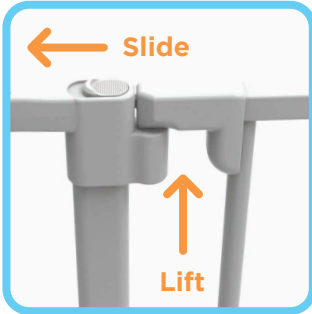

1.

Using one hand, place thumb on the button and grip Gate Panel with fingers. Slide button and lift Gate Panel.



2.

Open gate in either direction. When released gate will swing closed automatically.



3.

To enable stay open feature, open gate to a 90° angle.

NOTE: Always check gate is properly closed and secure at all times.

CLEANING INSTRUCTIONS

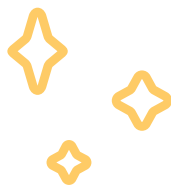

Simply use a soft damp cloth to wipe Playpen/Barrier, dry after cleaning. Do not use chemical or abrasive cleaners.

WARRANTY CERTIFICATE

Congratulations! You have made an excellent choice of this quality product. Our commitment to quality also includes our service. Should you, contrary to expectations, experience defects due to manufacturing faults, we will provide you with a warranty against defects as follows:

WARRANTY

The product is guaranteed to be free from defects in workmanship and parts for a period of 12 months from the date of purchase. Defects that occur within this warranty period, under normal use and care, will be repaired, replaced or refunded at our discretion. The benefits conferred by this warranty are in addition to all rights and remedies in respect of the product that the consumer has under the Competition and Consumer Act 2010 and similar state and territory laws.

Our goods come with guarantees that cannot be excluded under the Australian Consumer Law. You are entitled to a replacement or refund for a major failure and for compensation for any other reasonably foreseeable loss or damage. You are also entitled to have the goods repaired or replaced if the goods fail to be of acceptable quality and the failure does not amount to a major failure.

PROOF OF PURCHASE

This warranty is valid for the original purchase and is not transferable. Please keep your purchase docket, tax invoice or receipt as proof of purchase and date of which the purchase was made.

EXTENT OF WARRANTY

This warranty is limited to defects in workmanship or parts. All defective products or parts will be repaired or replaced. This warranty does not cover consumable items.

NORMAL WEAR AND TEAR

This warranty does not cover normal wear and tear to the products or parts.

EXCLUSIONS

This warranty does not cover:

- Any defects caused by an accident, misuse, abuse, improper installation or operation, lack of reasonable care, unauthorised modification, loss of parts, tampering or attempted repair by a person not authorised by the distributor.
- Any product that has not been installed operated or maintained in accordance with the manufacturer operating instructions provided with the product.
- Any product that has been used for purposes other than domestic use.

TO MAKE A CLAIM

If a defect in the goods appears within 12 months, you are entitled to claim a warranty. Please contact after sales support via the link below:

www.permachildsafety.com/contact-us

Please ensure that you have a copy of proof of purchase so that we are able to respond as quickly and efficiently as possible.

WARRANTY CARD

DETAILS:

PRODUCT NAME: 3-In-1 Playpen/ Barrier

PRODUCT NUMBER: White 2747 / Warm Black 2752 (Please circle)

YOUR NAME:

ADDRESS:

PHONE:

EMAIL:

DATE OF PURCHASE:

LOCATION OF PURCHASE:

We recommend that you keep a copy of your receipt, showing the date of purchase, with this warranty certificate and keep for your reference. In the event of a product fault, please contact after sales support. Ensure that you include the product details (as shown on this card) so that we are able to respond as quickly and efficiently as possible.



AFTER HOURS SUPPORT



Scan the QR code for Live Chat Support
or visit: permachildsafety.com/contact-us



Scan the QR code for Live Chat Support
or visit: permachildsafety.com/contact-us



Perma Child Safety



@permachildsafety