



AIR FRYER ESSENTIALS VISION

User guide

Please make sure to read this User Guide prior to using your unit.

Hello!

Welcome to Nutricook

Easy cooking, delicious food, better nutrition:
It's what you get when you're part of our Nutricook community.
We're so glad you've joined us!
Now let's get started.

Join us and
#ElevateYourLife
@nutricookworld

Explore more of our products
and accessories on our website.
www.nutricookworld.com

To get help:
Our customer service team is always ready
to answer questions or solve issues.
Email: support@nutricookworld.com

Contents

04	Before you begin
05	Important safeguards & cautionary information
09	What's included
10	Air fryer parts overview
11	Control panel details
12	Internal light
12	Initial test run
13	Preheating
13	Cooking
14	Cooking programs
15	Shaking food
16	Helpful tips
17	Care & maintenance
18	Troubleshooting
19	Warranty

Before you begin

1. **Remove and safely discard all packaging materials and any temporary labels from inside and outside of the Air Fryer. Ensure that there is no packaging underneath and around the Air Fryer basket and cooking tray.**
2. **Verify that all parts are accounted for.**
3. **Place the Air Fryer on a stable, level, clean, heat-resistant, dry surface and away from external heat sources. Ensure there is enough space behind and above the Air Fryer against the surface. Leave enough room to remove the Air Fryer basket safely.**
4. **Read all Important safeguards and cautionary information in this User guide. Failure to do so may result in property damage and/or personal injury.**
5. **Follow Care & maintenance instructions in this User guide to clean the air fryer before cooking. Wash both the Air Fryer basket and cooking tray with a warm, soapy water. Rinse and dry thoroughly before using.**
6. **Wipe the inside and outside of the Air Fryer with a slightly moist cloth and dry with a towel.**
7. **Place the cooking tray into the basket. Ensure the rubber stoppers are installed. Lock air Fryer basket to the body.**

Rubber Stoppers:

- **The cooking tray has 4 rubber stoppers that keep the cooking tray fitted to the bottom of the air fryer basket and prevent the tray from directly touching the basket and avoid damaging the non-stick coating.**
- **It is recommended to remove the rubber stoppers during cleaning only. To remove, pull out one side at a time starting from the bottom. To put it back, position the rubber into the holes and push in one side at a time. The rubber stoppers must be installed before using the air fryer.**

⚠️ *WARNING: Read this User guide carefully and completely, and retain for future reference. Failure to adhere to safety instructions may result in serious injury.

Important safeguards & cautionary information

⚠️ WARNING! This appliance generates heat and escaping steam during use. To avoid the risk of serious injury, carefully read all instructions before operating this appliance.

When using any electrical appliance, basic safety precautions should always be observed, including the following [critical information](#).

GENERAL SAFETY

- **DO NOT** touch hot surfaces. Use handles or knobs. Use oven mitts or potholders.
- **⚠️ CAUTION!** Extreme caution must be used when moving unit containing hot oil or other hot liquids.
- To protect against electrical shock, **DO NOT** immerse cord, plugs, or the unit in water or other liquid.
- Close supervision is necessary when any unit is used by or near children.
- This appliance is **NOT** a toy, and children should **NOT** play with it.
- Children should be supervised to ensure that they **DO NOT** play with the appliance.
- This appliance is **NOT** intended for use by persons (including children) with reduced physical, sensory or mental capabilities, or lack of experience and knowledge, unless they have been given supervision or instruction concerning use of the appliance by a person responsible for their safety.
- Unplug from outlet when not in use, during assembly, during disassembly, and before cleaning. Allow to cool before putting or taking off parts and before cleaning.
- **DO NOT** use appliance other than its intended use. For household countertop use only. **DO NOT USE** outdoors.
- This appliance is not intended to be operated by means of an external timer or separate remote-control system.
- **DO NOT** tamper with any of the safety mechanisms.
- **DO NOT** place on or near a hot gas, electric burner and or in a heated oven. Heat from an external source will damage the appliance.
- **DO NOT** use the air fryer near flammable materials such as curtains, tablecloths, etc. **ALWAYS** place and use the unit on a flat, stable and heat-resistant surface away from heat sources or liquids.
- **NEVER** put baking or parchment paper into the air fryer without food on top. Air circulation can cause paper to lift and touch heating element.
- **ALWAYS** use heat-safe containers. Be extremely cautious if using containers that aren't metal or glass.

- **NEVER** put the appliance against the wall or other appliances when cooking. There should be at least 5 inches of free space for the back side, left/right sides and the upper side of the appliance.
- **DO NOT** place anything on top of your air fryer. **DO NOT** store anything inside your air fryer other than the included accessories when not in use.
- To turn the unit off, press **CANCEL** (⏻) then remove plug from the wall outlet.
- **⚠ CAUTION! 🔥 HOT SURFACE:** This appliance generates heat and escaping steam during use. Proper precautions must be taken to prevent the risk of burns, fires or other injury to persons or damage to property.
- **⚠ CAUTION!** This appliance is hot during operation and retains heat for some time after turning OFF. **ALWAYS** wear proper hand protection when handling hot materials and allow metal parts to cool before cleaning. **DO NOT** place anything on top of the appliance while it is operating or while it is hot.
- Avoid making contact with moving parts.
- **DO NOT** place any combustible materials on the cooking chamber such as paper, cardboard, plastic, styrofoam or wood.
- Proper maintenance is recommended after each use. Refer to care and maintenance section of this user guide. Allow unit to cool before cleaning.
- **DO NOT** place oversized foods or metal utensils into the air

fryer as they may cause fire and/or personal injury.

- **DO NOT** overfill the air fryer basket with food. Excessive amount of food may touch the heating element and can cause a fire hazard.
- An air fryer works with hot air only. **NEVER** fill the basket with oil or fat. This could result in fire and/or personal injury.
- To avoid risk of fire, property damage and personal injury, **DO NOT** spray cooking oil into the cooking chamber.
- **⚠ WARNING! DO NOT** touch any accessories during or immediately after cooking. Allow unit to cool.
- **⚠ CAUTION!** During air frying, hot air is released from the air outlet opening. Keep your hands and face distance from the air outlet opening. Also, be careful of hot steam and air when you remove the Air Fryer Basket from the appliance.
- **⚠ CAUTION! DO NOT block the air vents.**
- **NEVER** use the air fryer without the basket in place. Air Fryer will not operate unless air fryer basket is fully closed.
- To avoid personal injury, **ALWAYS** use proper hand protection and exercise caution when adding or removing food from the air fryer basket.
- **⚠ CAUTION!** After hot air frying, the cooking tray and the air fryer basket and the cooked foods are hot. Extreme caution must be used when handling the air fryer basket.
- **NEVER** place unprotected hands inside the appliance until it has cooled to room temperature.

- **DO NOT** touch hot surfaces with unprotected hands.
- **⚠ CAUTION! Extreme caution must be observed when disposing hot oil or liquids from the air fryer basket.**
- **⚠ WARNING! DO NOT** turn the air fryer basket over after cooking as the hot cooking tray may fall out and create a safety hazard.
- When cooking naturally high fat foods, **DO NOT** turn the air fryer basket over after cooking as the cooking tray may fall out including the excess fats collected on the basket which can cause a safety hazard. Use a tong to transfer food from the basket.
- **DO NOT** clean with metal scouring pads. Metal fragments can break off the pad and touch electrical parts, creating a risk of electric shock.
- **DO NOT** rinse the appliance under tap.
- If the appliance starts emitting black smoke, immediately turn off and unplug your air fryer. White smoke is normal which can be caused by heating fat or food splashing. Black smoke indicates food is burning or there is a circuit problem. Wait for smoke to stop before opening the air fryer basket. **Contact customer service for any assistance.**
- If this appliance begins to malfunction during use, immediately pull the air fryer basket out of the body. Then remove plug from wall outlet. **DO NOT** use or attempt to repair the malfunctioning appliance.
- **DO NOT** leave this appliance unattended during use.

- Keep the cord out of reach of children and infants to avoid the risk of electric shock and choking.
- **⚠ WARNING!** After air frying, make sure to place the air fryer basket on a stable, level, clean, heat-resistant and dry surface when transferring food from the basket.
- **NEVER** move a hot Air Fryer or an Air Fryer containing hot food. Allow to cool before moving.
- **⚠ WARNING!** This Air Fryer should **NOT** be used to boil water.
- **⚠ WARNING!** This Air Fryer should **NEVER** be used to deep fry foods.
- All users of this appliance must read and understand this instruction manual before operating or cleaning this appliance. Failure to follow any of the important safeguards and instructions for safe use is a misuse of your appliance that can void your warranty and create the risk of serious injury.

ELECTRICAL SAFETY

⚠ CAUTION: To avoid risk of electric shock, **NEVER** immerse the cord, plug, or air fryer base in water or other liquids.

- **DO NOT** use this product in locations with different electrical specifications or plug types. Do not operate with any type of plug adapter or voltage converter device, as these may cause electrical shorting, fire, electric shock, personal injury or product damage.
 - **DO NOT** modify the plug in any way, as doing so will void the warranty.
 - **DO NOT** pull, twist or mistreat the power cord.
 - The use of attachments or parts not recommended and sold by Nutricook may cause fire, electric shock, personal injury, or product damage and will void the warranty.
 - If the supply cord is damaged, it must be replaced by its service agent or similarly qualified persons in order to avoid a hazard.
 - **ALWAYS** POWER OFF and UNPLUG the appliance when it is not in use or BEFORE cleaning.
 - **DO NOT** allow the cord to hang over the edge of the table or counter. **DO NOT** pull, twist, or damage the power cord. **DO NOT** allow cord to touch hot surfaces, including the stove.
 - **DO NOT** let cord hang over edge of table or counter, or touch hot surfaces. The cord can get tangled or cause the appliance to fall. Bring it to a qualified technician for examination, repair or electrical and mechanical adjustment.
- **DO NOT** operate this appliance with a damaged cord or plug or if the appliance malfunctions, or is dropped or damaged in any manner.
 - Use of adapters and converters is considered an unauthorized modification of the product and as such voids the warranty. Use of this product in locations with different electrical specifications may result in damage to the product.
 - **DO NOT** use an extension cord. A short power-supply cord is used for this appliance to reduce the risk of children grabbing the cord and prevent it from draping over the counter or tabletop where it could be accidentally pulled off or tripped over.

PLASTICIZER WARNING

⚠ CAUTION: To prevent Plasticizers from migrating from the finish of the countertop or tabletop or other furniture, place **NON-PLASTIC** coasters or place mats between the appliance and the finish of the countertop or tabletop. Failure to do so may cause the finish to darken; permanent blemishes may occur or stains can appear.

Save these instructions!

FOR HOUSEHOLD USE ONLY

What's included

- 1500W AIR FRYER BASE
- AIR FRYER BASKET
- COOKING TRAY
- USER GUIDE

Product Specification:

MODEL	CAPACITY	POWER	VOLTAGE	WEIGHT	DIMENSION
AIR FRYER ESSENTIALS VISION AFE152V-G	5.2 L	1500 W	220-240 V 50/60 Hz	4.6 kg	37.2 x 27.6 x 29.5 cm

Air fryer parts overview

*NOTE: Images are for visual representations only. Always refer to actual product.

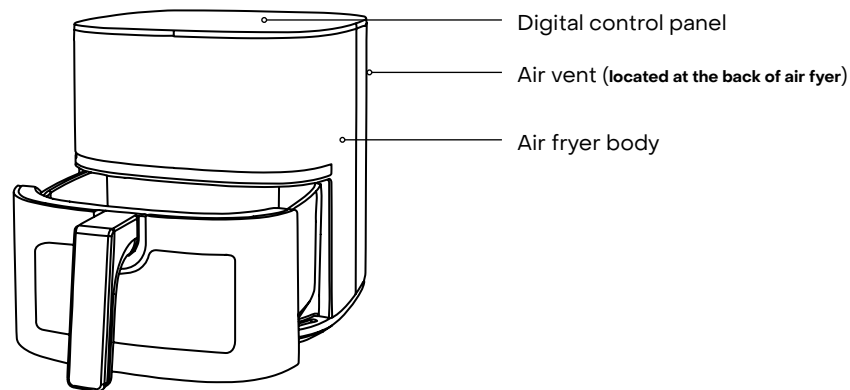
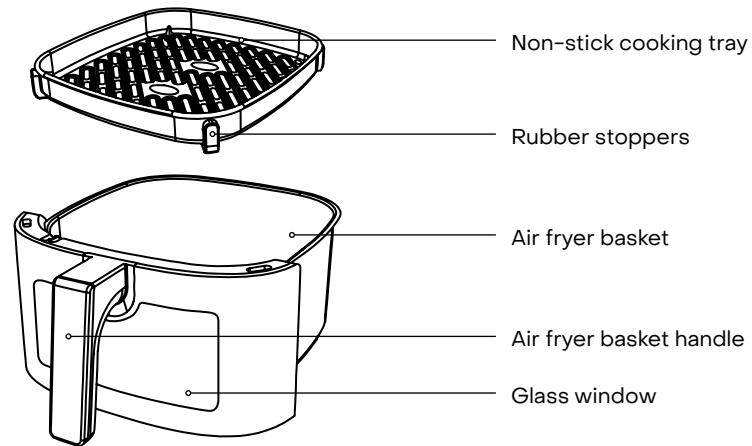

Control panel details

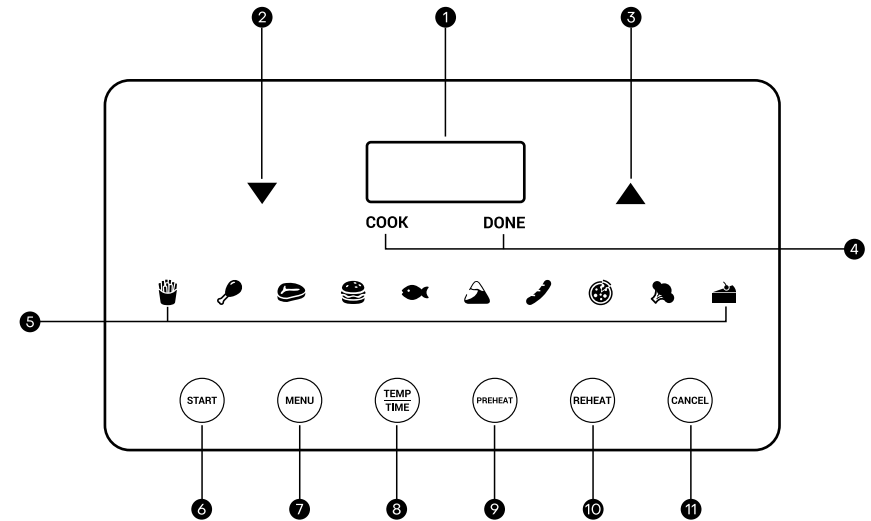

- 1 Digital screen**
Displays cooking temperature and cooking time.
- 2 Arrow down button**
Use to decrease cooking time and temperature.
- 3 Arrow up button**
Use to increase cooking time and temperature.
- 4 Cooking Status Indicator**
COOK – illuminates during cooking.
DONE – illuminates once cooking is complete.

- 5 Preset cooking programs**
Preset cooking programs have automatic temperature and time settings (see **Preset Programs Table** for the default time and temperature). Select any of the following cooking program by pressing the MENU button.

Fries	Steak
Chicken	Fish
Burger	Pizza
Sausage	Broccoli
Samosa	Cake

- 6 START button**
Use to start cooking.
- 7 MENU button**
Use to cycle through the cooking programs.

8 TEMP/TIME button

Press to select between cooking temperature and time before making adjustments.

9 PREHEAT button

Use to preheat the Air Fryer before cooking to save time and improves the texture of the food.

10 REHEAT button

Use for reheating leftovers (such as pizza) producing a crispy result.

11 CANCEL button

Use to cancel a program at any time (during program selection or during cooking cycle). Pressing this button will return the unit to standby mode.

Internal light

Internal light automatically switches on as soon as cooking starts until complete.

Initial test run

This step is optional but recommended to get yourself familiarized with the Air Fryer Essentials and ensure it is working properly. It will also help eliminate any residue or traces of odor in the Air Fryer that may remain after shipping.

NOTE: This process must be done with no food in the Air Fryer basket.

1. Place air fryer on a stable, level, clean, heat-resistant, and dry surface, close to an electrical outlet.
2. Ensure the cooking tray is inserted into the air fryer basket without any food.
3. Plug in unit to a power outlet.
4. Press **MENU** button. By default, the **FRIES** icon blinks.
5. Press **TEMP/TIME** and set temperature to 200 °C.
6. Press **TEMP/TIME** and set time to 5 minutes.
7. Press **START** to begin initial test run.
8. After time is complete, **End** appears on the display.
9. Allow unit to cool.

You're all set. Happy cooking!

Preheating

Preheating the Air Fryer before placing food is recommended unless the unit is already hot from a previous cooking cycle. Preheating saves cooking time and improves the texture of cooked foods.

1. Place Air Fryer on a stable, level, clean, heat-resistant and dry surface, close to an electrical outlet.
2. Ensure the air fryer basket is locked into the unit.
3. Plug in unit to a power outlet.
4. Press **PREHEAT**.
5. Optionally, adjust **PREHEAT** temperature and time. Press **TEMP/TIME** button and use the set of arrows to adjust temperature or time.
6. Press **START** to begin **Preheating**.
7. Once **Preheating** is complete, screen displays dash lines.











Cooking

⚠ CAUTION!

- **DO NOT** touch hot surface and accessories during or immediately after cooking. The air fryer basket and cooking tray become extremely hot during the cooking process. Avoid physical contact with hot parts. **ALWAYS** wear proper hand protection when handling hot materials to avoid burns and serious physical injury. Allow accessories to completely cool before cleaning.
- **DO NOT** overfill the air fryer basket with food. Overfilling will result to uneven cooking. It is recommended to fry smaller batches of food as this will allow proper air circulation for even cooking and browning.
- **ALWAYS** be careful of hot steam when opening the air fryer basket during and after cooking.
- **DO NOT** place oversized foods or metal utensils into the air fryer.
- **DO NOT** block the air vents.
- **DO NOT** leave this appliance unattended during use.
- **ALWAYS** use oven mitts or heat-resistant gloves, as well as silicone-tipped tongs to flip, shake or when taking out your food. Be extremely careful as the unit and the cooked foods are very hot.

Cooking programs

These programs are designed with pre-programmed time and temperature for certain foods to take the guess work out of cooking.

Preset icon	Description	Default Time	Time Range	Default Temperature °C	Temperature Range
	Fries	18 min	1 min - 1 hour	200°C	40°C - 200°C
	Chicken	25 min	1 min - 1 hour	190°C	40°C - 200°C
	Steak	16 min	1 min - 1 hour	200°C	40°C - 200°C
	Burger	20 min	1 min - 1 hour	200°C	40°C - 200°C
	Fish	8 min	1 min - 1 hour	200°C	40°C - 200°C
	Samosa	18 min	1 min - 1 hour	200°C	40°C - 200°C
	Sausage	14 min	1 min - 1 hour	180°C	40°C - 200°C
	Pizza	12 min	1 min - 1 hour	160°C	40°C - 200°C
	Broccoli	8 min	1 min - 1 hour	150°C	40°C - 200°C
	Cake	30 min	1 min - 1 hour	150°C	40°C - 200°C

1. Preheat air fryer. Follow the steps in Preheating.
2. Once preheating is complete, add food into the basket.
3. Select program by pressing the MENU button. Press repeatedly until the desired cooking program is selected.
4. Adjust temperature by pressing the **TEMP/TIME** button then use the set of arrows.
5. Adjust cooking time by pressing the **TEMP/TIME** button then use the set of arrows.

- Note:**
Temperature and time adjustments can be done during program selection or at any point during the cooking cycle.
6. Press **START** to begin.
 7. When the cooking time is complete, screen displays **End**.
 8. Pull the air fryer basket from the unit and place on a clean, flat surface.
⚠ WARNING! Be careful of hot steam.
 9. Transfer the food from the Air Fryer basket and serve.

10. Allow the Air Fryer basket and cooking tray to completely cool before cleaning.

Shaking food

During the cooking process, shake the basket or flip your food for even cooking and browning. It is recommended to shake the basket or flip your food once or more, if desired.

⚠ CAUTION:

- **Always** be careful of hot steam when pulling the air fryer basket from the unit.

1. Hold the air fryer basket just above a heat resistant surface and shake it or flip food carefully.
Note: When cooking naturally high fat foods, flip the food using a silicone-tipped tong. **DO NOT** shake the basket to avoid risk of hot liquids splashing.
2. Depending on the food, the basket might be too heavy to shake. In this case, ensure to place the Air Fryer basket on a stable and heat-resistant surface then shake it or flip food carefully. If basket won't shake because of the weight, use a silicone-tipped tong instead.

⚠ WARNING!

- For safety purposes, it is recommended to use silicone-tipped tongs to

flip food that contains oil or any hot liquids. Any excess oil and liquids can splash from the basket when shaking.

- Always drain any excess oil or hot liquids from the air fryer basket. Excess oil may produce extra smoke when heated for longer period.

Helpful tips

1. Always pat food dry before cooking to encourage browning and avoid excess smoke.
2. **DO NOT** overfill the air fryer basket with food. Overfilling will result to uneven cooking. It is recommended to fry smaller batches of food as this will allow proper air circulation for even cooking and browning.
3. Spray oil works best. Oil is distributed evenly, and less oil is needed. Use oils with high-smoke point like canola, avocado, grapeseed or vegetable oil to help reduce smoke while cooking. Oils with low smoke point like olive oil produce more smoke.
4. It is recommended to spray or add a small amount of oil to your food if adding seasoning or breading to ensure that these light ingredients stick to the food. The air fryer rapidly circulates air and pushes it to your food during the cooking process which can take out light ingredients if they are not properly adhered to the food.
5. When cooking naturally high fat foods, it is recommended to empty oil and fats collected on the basket between batches to avoid excess smoke.
6. It is recommended to shake the basket or flip your food once or more, as desired to check for doneness. This will also allow even cooking and browning. Always observe safety precautions when shaking the basket or flipping foods.

Care & maintenance

⚠ WARNING: To avoid electric shock or damage to your air fryer, **ALWAYS** unplug the power cord from the power supply outlet before cleaning. Make sure that all parts and accessories of your air fryer have cooled down completely.

- ⚠ CAUTION:**
- **DO NOT** immerse the power cord or your air fryer in water or any other liquids.
 - **DO NOT** use abrasive cleaners, steel wool, or scouring pads.
 - **DO NOT** clean with metal scouring pads. Metal fragments can break off the pad and touch electrical parts, creating a risk of electric shock.
 - Dry all parts and accessories thoroughly after cleaning, before using, or before storing your air fryer.
 - Make sure that all parts and surfaces are completely dry before connecting your air fryer to a power outlet. Wet parts can cause electric shock.
 - **ALWAYS** clean your air fryer thoroughly every after use.
 - **DO NOT** store anything on top of the air fryer.
 - **DO NOT** store anything inside your air fryer other than the cooking tray.

Parts and Accessories	Cleaning method and tips
Air Fryer Base and Plug Cord	<ul style="list-style-type: none"> • Wipe the outer part of the air fryer with soft and barely damp cloth. Dry with a towel thoroughly. • DO NOT submerge in water or any other liquids. • Clean the inner part of the air fryer with soft and barely damp cloth including the heating coil to remove baked-on grease and food debris/residue. Wipe it dry with a soft cloth. <p>⚠ WARNING! ALWAYS ensure that the inner and outer surface including the heating coil is dry before storing or using the air fryer.</p>
Air Fryer Basket	<ul style="list-style-type: none"> • Wash the air fryer basket with warm, soapy water and non-abrasive sponge. Ensure that baked-on grease and food debris/residue are removed. Rinse well and dry thoroughly. <p>NOTE: The air fryer basket is dishwasher-safe. NOTE: The air fryer basket has a non-stick coating. To avoid any damage on the non-stick coating, NEVER use metal utensils and abrasive cleaning materials.</p>
Cooking tray and rubber stoppers	<ul style="list-style-type: none"> • Remove the 4 rubber stoppers and wash with warm, soapy water and non-abrasive sponge. Ensure that all grease and food debris are removed. Rinse well and dry thoroughly. Install the rubber stoppers before putting the cooking tray back in the air fryer basket. • Wash the cooking tray with warm, soapy water and non-abrasive sponge. Ensure that all grease and food debris are removed. Rinse well and dry thoroughly. <p>NOTE: The cooking tray has a non-stick coating. To avoid any damage on the non-stick coating, NEVER use metal utensils and abrasive cleaning materials.</p>

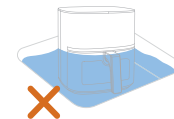

⚠ WARNING: DO NOT immerse air fryer in water.

Troubleshooting

Issue	Possible Cause	Solution
Air Fryer will not turn on	Unit is not plugged in.	Plug in unit to an electrical outlet. DO NOT use the unit in locations with different electrical specifications or plug types.
Food is undercooked	Air fryer basket is overloaded.	DO NOT overfill the air fryer basket with food. Overfilling will result to uneven cooking. It is recommended to fry smaller batches of food as this will allow proper air circulation for even cooking and browning. It is recommended to shake the basket or flip your food once or more, as desired to check for doneness. This will also allow even cooking and browning.
White smoke is coming out from the unit	Excess oil and naturally high fat foods may produce white smoke while cooking.	This is normal. It is recommended to empty oils or fats accumulated in the cooking pot between batches of cooking to avoid excess smoke.
	The air fryer basket and cooking tray have not been cleaned from previous use.	Follow care and maintenance instruction to clean accessories and remove dried food debris or grease after every use.
	Using oil with low smoke point such as olive oil may excess smoke.	Use oil with high smoke point such as avocado, canola or grapeseed oil.
Black smoke is coming out from the unit	Food is burning.	Immediately turn off the unit and unplug. Wait for smoke to stop before opening the air fryer basket. Clean all accessories thoroughly.
	There is a circuit problem.	Immediately turn off the unit and unplug. Wait for smoke to stop before opening the air fryer basket. Contact customer service for assistance. ⚠ WARNING: DO NOT attempt to use the unit.
Display shows error code E1	Temperature sensor open circuit.	⚠ WARNING: Stop using the unit when these error codes appear.
Display shows error code E2	Temperature sensor turnoff.	Disconnect from power supply and contact Customer Service immediately.

NOTE: If you encounter any issue which is not listed above, contact Customer Service at **800-NUTRI (68874)** or email **support@nutricookworld.com** for assistance.

Warranty

LIMITED WARRANTY FOR NUTRICOOK

Nutricook’s limited warranty obligations are confined to the terms set forth below:

Nutricook warrants this product against defects in materials and workmanship for a period of **two years** from the date of original retail purchase. This limited warranty is valid only in the country in which the product is purchased and comes with the product at no extra charge, however shipping and processing fees will be incurred for returns, replacements and or refunds.

OBTAINING WARRANTY SERVICE

For limited warranty service, simply visit **www.nutricookworld.com** for Customer Service details of your respective territory or contact our customer service department at **support@nutricookworld.com** and we will be glad to help you. When you contact our customer service department you will be asked for your name, address, telephone number and to provide proof of the original purchase (receipt) containing a description of the product(s), purchase date, and the appropriate Nutricook bar code(s). Before you send your product for limited warranty service please make sure to keep a copy of all relevant documents for your files (receipt, etc.). It is always recommended to purchase product insurance and tracking services when sending your product for service. Remember, shipping and processing fees will be incurred and are not covered by the two-year limited warranty.

EXCLUSIONS AND LIMITATIONS

This **Nutricook Two-Year Limited Warranty** applies only to Nutricook products distributed by or for Nutricook that can be identified by the “Nutricook” trademark, trade name, logo and bar code.

Nutricook’s Two-Year Limited Warranty does not apply to any other products that may appear to be authentic, but were not distributed/sold by Nutricook.

Normal wear and tear is not covered by this limited warranty.

This limited warranty applies to consumer use only, and is void when the product is used in a commercial or institutional setting.

This limited warranty extends only to the original consumer purchaser and is not transferable. In addition, proof of purchase must be demonstrated.

Repair or replacement of the product (or, if repair or replacement is not feasible, a refund of the purchase price) is the exclusive remedy of the consumer under this limited warranty. Nutricook shall not be liable for any incidental or consequential damages for breach of this limited warranty or any implied warranty on this product.

This limited warranty does not apply:

- (a) to damage caused by accident, abuse, misuse, or misapplication;
- (b) to damage caused by improper maintenance (including unauthorized parts service);
- (c) to a product or a part that has been modified in any way;
- (d) if any Nutricook bar code or trademark has been removed or defaced; and
- or (e) if the product has been used with an adapter/converter.

THIS LIMITED WARRANTY AND THE REMEDIES SET FORTH ABOVE ARE EXCLUSIVE AND IN LIEU OF ALL OTHER WARRANTIES, REMEDIES AND CONDITIONS, WHETHER ORAL OR WRITTEN, EXPRESS OR IMPLIED. NUTRICOOK SPECIFICALLY DISCLAIMS ANY AND ALL IMPLIED WARRANTIES, INCLUDING, WITHOUT LIMITATION, WARRANTIES OF MERCHANTABILITY AND FITNESS FOR A PARTICULAR PURPOSE. IF NUTRICOOK CANNOT LAWFULLY DISCLAIM IMPLIED WARRANTIES UNDER THIS LIMITED WARRANTY, ALL SUCH WARRANTIES, INCLUDING WARRANTIES OF MERCHANTABILITY AND FITNESS FOR A PARTICULAR PURPOSE ARE LIMITED IN DURATION TO THE DURATION OF THIS LIMITED WARRANTY. No Nutricook reseller, agent, or employee is authorized to make any modification to this warranty.

NUTRICOOK IS NOT RESPONSIBLE FOR DIRECT, SPECIAL, INCIDENTAL OR CONSEQUENTIAL DAMAGES RESULTING FROM ANY BREACH OF WARRANTY OR CONDITION, OR UNDER ANY OTHER LEGAL THEORY, INCLUDING BUT NOT LIMITED TO LOST PROFITS, DOWNTIME, GOODWILL, DAMAGE TO OR REPLACEMENT OF EQUIPMENT AND PROPERTY. NUTRICOOK SPECIFICALLY DOES NOT REPRESENT THAT IT WILL BE ABLE TO REPAIR ANY PRODUCT UNDER THIS LIMITED WARRANTY.

Notes



AIR FRYER ESSENTIALS VISION

Model No. AFE152V

nutricook® | www.nutricookworld.com | All rights reserved.

Illustrations may differ from the actual product. We are constantly striving to improve our products, therefore the specifications contained herein are subject to change without notice.

Nutricook is a registered trademark of Caliber Brands FZE.

AFE152V_Series_UG_V1.202307