

WARM & COZY MUG RUGS



12
Designs

Fits hoop sizes 6" x 10" and larger

THREAD LIST



Isacord Thread Colors

0015 White
0832 Sisal
0933 Redwood
1140 Meringue
1141 Tan
1301 Paprika
1753 Strawberries N' Cream
1860 Shell
1900 Geranium
1906 Tulip
2051 Teaberry
4174 Charcoal
5722 Green Grass
5730 Apple Green
5740 Mint

***Project instructions included after design list**

Note: Some designs in this collection may have been created using unique special stitches and/or techniques. To preserve design integrity when rescaling or rotating designs in your software, always rescale or rotate designs using the handles directly on-screen.

***Fabric Required**

12882-01 House Mug Rug Applique

Size Inches: Size mm: Stitch Count:
7.17 X 6.06 in. **182.1 X 154.0 mm** **15114 St.**



| | | |
|---|---|------|
| ■ | 1. Batting & Red Fabric Placement Stitch..... | 1753 |
| ■ | 2. Batting & Red Fabric Tackdown..... | 1753 |
| ■ | 3. Light Red Detail | 1753 |
| ■ | 4. Green Fabric Placement Stitch..... | 5740 |
| ■ | 5. Cut Line & Tackdown | 5740 |
| ■ | 6. Brown Fabric Placement Stitch..... | 5740 |
| ■ | 7. Cut Line & Tackdown | 5740 |
| ■ | 8. Mint Green Cover Stitch & Detail | 5740 |
| ■ | 9. Light Green Detail | 5730 |
| ■ | 10. Red Detail | 1900 |
| ■ | 11. Brown Detail | 0933 |
| ■ | 12. Tan Detail..... | 1141 |
| □ | 13. White Fabric Placement Stitch..... | 0015 |
| □ | 14. Cut Line & Tackdown | 0015 |
| □ | 15. White Cover Stitch & Detail | 0015 |
| ■ | 16. Pink Detail..... | 2051 |
| ■ | 17. Light Brown Detail..... | 0832 |
| ■ | 18. Seam | 1900 |

Note: Some designs in this collection may have been created using unique special stitches and/or techniques. To preserve design integrity when rescaling or rotating designs in your software, always rescale or rotate designs using the handles directly on-screen.

12882-02 Cozy Cup Mug Rug Applique

Size Inches: Size mm: Stitch Count:
7.15 X 6.06 in. **181.5 X 154.0 mm** **14540 St.**



| | |
|---|---|
| ■ | 1. Batting & Light Brown Fabric Placement Stitch ..0832 |
| ■ | 2. Batting & Light Brown Fabric Tackdown0832 |
| ■ | 3. Green Fabric Placement Stitch.....0832 |
| ■ | 4. Cut Line & Tackdown0832 |
| ■ | 5. White Fabric Placement Stitch.....0832 |
| ■ | 6. Cut Line & Tackdown0832 |
| ■ | 7. Red Fabric Placement Stitch0832 |
| ■ | 8. Cut Line & Tackdown0832 |
| ■ | 9. Light Brown Detail.....0832 |
| ■ | 10. Mint Green Cover Stitch & Detail5740 |
| ■ | 11. Green Detail.....5722 |
| □ | 12. White Straw & Linework.....0015 |
| ■ | 13. Tan Straw Shading & Detail 1140 |
| ■ | 14. Straw Stripes & Heart 1906 |
| ■ | 15. Light Red Straw & Cup Detail 1753 |
| ■ | 16. White Fabric Cover Stitch & Detail 1140 |
| ■ | 17. Red Fabric Cover Stitch.....1906 |
| ■ | 18. Light Pink Detail.....1860 |
| □ | 19. White Linework0015 |
| ■ | 20. Seam 1140 |

Note: Some designs in this collection may have been created using unique special stitches and/or techniques. To preserve design integrity when rescaling or rotating designs in your software, always rescale or rotate designs using the handles directly on-screen.

12882-03 Gingerbread Man Mug Rug Applique

Size Inches: Size mm: Stitch Count:
7.17 X 6.06 in. **182.2 X 154.0 mm** **15391 St.**



















| | | |
|--|--|------|
| | 1. Batting & White Fabric Placement Stitch | 5740 |
| | 2. Batting & White Fabric Tackdown | 5740 |
| | 3. Dark Red Fabric Placement Stitch..... | 5740 |
| | 4. Cut Line & Tackdown | 5740 |
| | 5. Red Fabric Placement Stitch | 5740 |
| | 6. Cut Line & Tackdown | 5740 |
| | 7. Brown Fabric Placement Stitch..... | 5740 |
| | 8. Cut Line & Tackdown | 5740 |
| | 9. Light Green Bulbs | 5740 |
| | 10. Medium Red Bulbs | 1906 |
| | 11. Light Red Bulbs | 1753 |
| | 12. Light String..... | 5730 |
| | 13. Light Pink Cover Stitch & Linework..... | 1860 |
| | 14. Light Brown Cover Stitch | 0832 |
| | 15. Brown Detail | 0933 |
| | 16. White Detail | 0015 |
| | 17. Seam | 0015 |

Note: Some designs in this collection may have been created using unique special stitches and/or techniques. To preserve design integrity when rescaling or rotating designs in your software, always rescale or rotate designs using the handles directly on-screen.

12882-04 Joy Love Cookies Mug Rug Applique

Size Inches: Size mm: Stitch Count:
7.17 X 6.06 in. 182.0 X 154.0 mm 22374 St.



| | | |
|---|--|------|
|  | 1. Batting & White Fabric Placement Stitch | 1860 |
|  | 2. Batting & White Fabric Tackdown | 1860 |
|  | 3. Dark Red Fabric Placement Stitch..... | 1860 |
|  | 4. Cut Line & Tackdown | 1860 |
|  | 5. Green Fabric Placement Stitch..... | 1860 |
|  | 6. Cut Line & Tackdown | 1860 |
|  | 7. Brown Fabric Placement Stitch..... | 1860 |
|  | 8. Cut Line & Tackdown | 1860 |
|  | 9. Light Pink Detail..... | 1860 |
|  | 10. Light Red Cover Stitch & Detail | 1753 |
|  | 11. Mint Letters & Detail | 5740 |
|  | 12. Light Green Cover Stitch & Detail..... | 5730 |
|  | 13. Light Tan Letters & Detail..... | 1140 |
|  | 14. Light Brown Cover Stitch & Detail..... | 0832 |
|  | 15. Brown Detail | 0933 |
|  | 16. White Linework & Detail..... | 0015 |
|  | 17. Seam | 0015 |

Note: Some designs in this collection may have been created using unique special stitches and/or techniques. To preserve design integrity when rescaling or rotating designs in your software, always rescale or rotate designs using the handles directly on-screen.

12882-05 Snowman Mug Rug Applique

Size Inches: Size mm: Stitch Count:
7.20 X 6.06 in. **182.9 X 154.0 mm** **19443 St.**



| | | |
|---|---|------|
|  | 1. Batting & Red Fabric Placement Stitch..... | 1860 |
|  | 2. Batting & Red Fabric Tackdown | 1860 |
|  | 3. Brown Fabric Placement Stitch..... | 1860 |
|  | 4. Cut Line & Tackdown | 1860 |
|  | 5. White Fabric Placement Stitch..... | 1860 |
|  | 6. Cut Line & Tackdown | 1860 |
|  | 7. Light Pink Scarf & Detail | 1860 |
|  | 8. Light Red Detail | 1753 |
|  | 9. Light Tan Cover Stitch..... | 1140 |
|  | 10. Light Brown Detail..... | 0832 |
|  | 11. White Cover Stitch & Detail | 0015 |
|  | 12. Scarf Outlines & Detail..... | 1906 |
|  | 13. Coals..... | 4174 |
|  | 14. Carrot..... | 1301 |
|  | 15. Seam | 1753 |

12882-06 Little Wreath Mug Rug Applique

Size Inches: Size mm: Stitch Count:
7.16 X 6.06 in. **181.8 X 154.0 mm** **20132 St.**



| | | |
|---|---|------|
|  | 1. Batting & Light Brown Fabric Placement Stitch .. | 5740 |
|  | 2. Batting & Light Brown Fabric Tackdown | 5740 |
|  | 3. Green Fabric Placement Stitch..... | 5740 |
|  | 4. Cut Line & Tackdown | 5740 |
|  | 5. Mint Cover Stitch & Leaves | 5740 |
|  | 6. Green Detail..... | 5722 |
|  | 7. Light Brown Linework | 0832 |
|  | 8. Berries | 1906 |
|  | 9. Seam | 0832 |

Note: Some designs in this collection may have been created using unique special stitches and/or techniques. To preserve design integrity when rescaling or rotating designs in your software, always rescale or rotate designs using the handles directly on-screen.

12882-07 Cocoa Cup Cozy

Size Inches: Size mm: Stitch Count:
9.03 X 3.09 in. **229.3 X 78.4 mm** **18116 St.**

| | | |
|--|--|------|
| | 1. White Fabric Placement Stitch..... | 0015 |
| | 2. Button & Elastic Placement Guide..... | 0015 |
| | 3. White Candy Detail..... | 0015 |
| | 4. Mint Detail..... | 5740 |
| | 5. Light Green Detail..... | 5730 |
| | 6. Green Outlines..... | 5722 |
| | 7. Light Brown Detail..... | 0832 |
| | 8. Brown Detail..... | 0933 |
| | 9. Medium Red Detail..... | 1906 |
| | 10. Light Red Detail..... | 1753 |
| | 11. White Detail..... | 0015 |
| | 12. Light Brown Detail..... | 0832 |
| | 13. Light Tan Outlines..... | 1140 |
| | 14. Light Pink Detail..... | 1860 |
| | 15. Seam..... | 0015 |



12882-08 Scarf Cozy

Size Inches: Size mm: Stitch Count:
9.03 X 3.09 in. **229.3 X 78.4 mm** **21138 St.**

| | | |
|--|--|------|
| | 1. Red Fabric Placement Stitch..... | 1906 |
| | 2. Button & Elastic Placement Guide..... | 1906 |
| | 3. Mint Detail..... | 5740 |
| | 4. Green Detail..... | 5722 |
| | 5. Medium Red Detail..... | 1906 |
| | 6. White Detail..... | 0015 |
| | 7. Seam..... | 1906 |



Note: Some designs in this collection may have been created using unique special stitches and/or techniques. To preserve design integrity when rescaling or rotating designs in your software, always rescale or rotate designs using the handles directly on-screen.

12882-09 Cuddle In A Cup Cozy





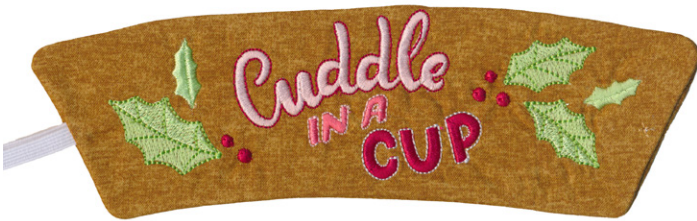

Size Inches: Size mm: Stitch Count:
9.04 X 3.09 in. **229.7 X 78.4 mm** **11752 St.**

| | | |
|---|--|------|
|  | 1. Brown Fabric Placement Stitch..... | 0832 |
|  | 2. Button & Elastic Placement Guide..... | 0832 |
|  | 3. Light Red Letters | 1753 |
|  | 4. Light Pink Letters & Detail | 1860 |
|  | 5. Medium Red Letters & Detail..... | 1906 |
|  | 6. White Detail | 0015 |
|  | 7. Leaves | 5740 |
|  | 8. Leaf Detail..... | 5730 |
|  | 9. Seam | 0832 |



12882-10 Wreath Leaves Cozy

Size Inches: Size mm: Stitch Count:
9.03 X 3.09 in. **229.3 X 78.4 mm** **9393 St.**

| | | |
|---|--|------|
|  | 1. Tan Fabric Placement Stitch | 1140 |
|  | 2. Button & Elastic Placement Guide..... | 1140 |
|  | 3. Leaves | 5740 |
|  | 4. Green Linework | 5722 |
|  | 5. Berries | 1906 |
|  | 6. Seam | 1140 |



Note: Some designs in this collection may have been created using unique special stitches and/or techniques. To preserve design integrity when rescaling or rotating designs in your software, always rescale or rotate designs using the handles directly on-screen.

12882-11 Love Snow Cozy

Size Inches: Size mm: Stitch Count:
9.02 X 3.09 in. **229.2 X 78.4 mm** **5992 St.**

- 1. Red Fabric Placement Stitch1906
- 2. Button & Elastic Placement Guide1906
- 3. Light Red Letters & Detail1753
- 4. White Letters & Detail0015
- 5. Light Pink Detail1860
- 6. Seam1906



12882-12 Christmas Lights Cozy

Size Inches: Size mm: Stitch Count:
9.02 X 3.09 in. **229.1 X 78.4 mm** **4813 St.**

- 1. Green Fabric Placement Stitch5730
- 2. Button & Elastic Placement Guide5730
- 3. Medium Red Bulbs1906
- 4. Light Red Bulbs1753
- 5. Mint Bulbs5740
- 6. Light Pink Bulbs1860
- 7. Green String & Detail5730
- 8. Seam5730



Stabilizers

- OESD Medium Weight TearAway
- OESD Fuse and Fleece
- OESD Fuse and Seal

Fabrics/Textiles

- White cotton fabric:
 - (1) 7" x 12" envelope enclosure
 - (1) 7" x 6" envelope enclosure
 - (1) 7" x 8" front
- Dark red cotton fabric (1) 2.25" x 5"
- Red cotton fabric (1) 3.5" x 3"
- Brown cotton fabric (1) 4.75" x 4.25"

Notions & Tools

- OESD Expert Embroidery Tape TearAway
- OESD Expert Point and Press Tool
- OESD Perfect Embroidery Press Cloth
- Embroidery Needle Sharp 75/11

Isacord Thread Colors

- Per thread chart

EMBROIDERY



STEP 1

- Fuse a layer of Fuse and Fleece to the back of the 7" x 8" white fabric.
- Fold the remaining white fabrics (7" x 12" and 7" x 6") in half, wrong sides together.
- Press.
- Note:
 - After folding 7" x 12" will measure approximately 7" x 6".
 - After folding 7" x 6" will measure approximately 7" x 3".
- Press.

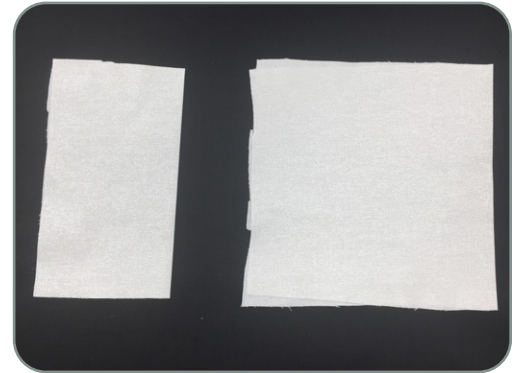

STEP 2

- Hoop one layer of Ultra Clean and Tear.
- Place the hoop on the machine.
- Load the design.
- Thread the machine per the thread chart.

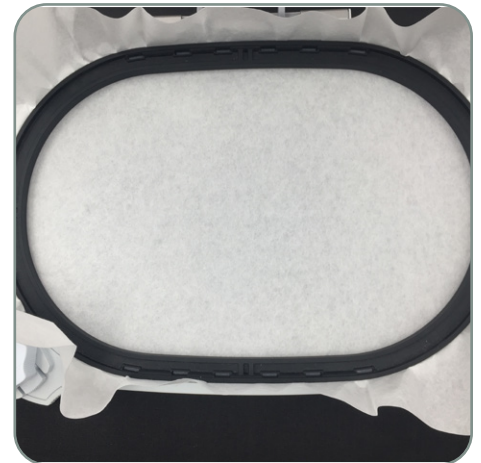

STEP 3

- Stitch Machine Step 1, Batting and White Fabric Placement Stitch.

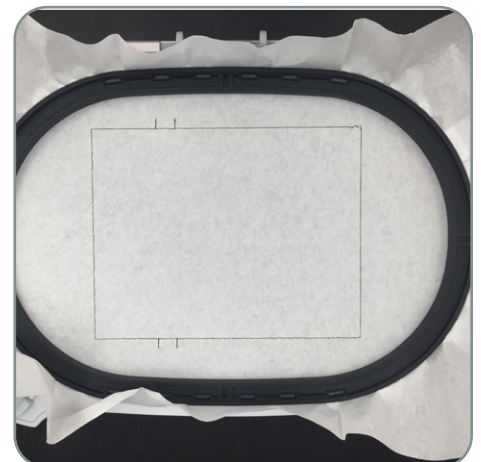

STEP 4

- Remove the hoop from the machine, but NOT the project from the hoop.
- Place on a flat surface.
- With a pen, extend the placement lines on each side of the rectangle to the edge of the hoop as shown.



STEP 5

- Position the background fabric (white fabric backed with Fuse and Fleece) right side up, completely covering the placement stitch.
- Tape to secure.



STEP 6

- Return the hoop to the machine.
- Stitch Machine Step 2, Batting and White Fabric.

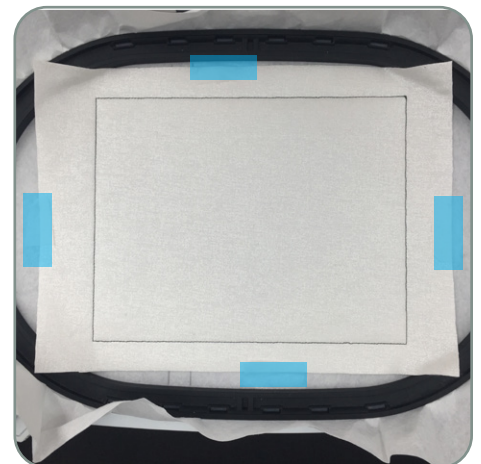

EMBROIDERY



STEP 7

- Remove the hoop from the machine, but NOT the project from the hoop.
- Trim the white background fabric about 1/8" outside of the tackdown stitching.

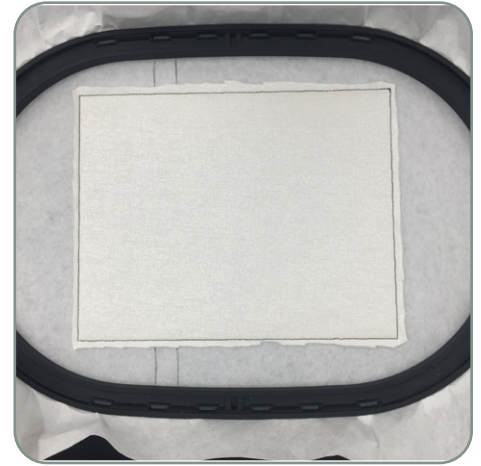

STEP 8

- Return the hoop to the machine.
- Stitch Machine Step 3, Dark Red Fabric Placement.

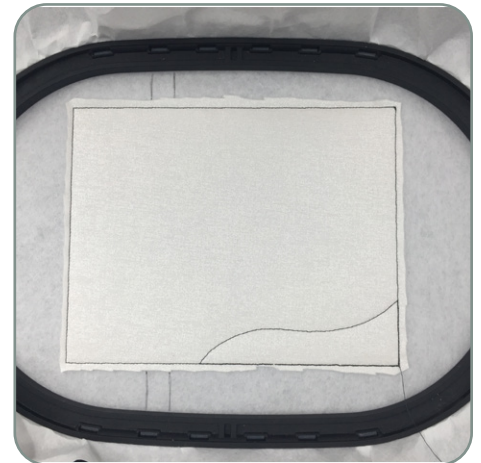

STEP 9

- Position the dark red fabric over the placement stitch.
- Stitch Machine Step 4, Cut Line and Tackdown.



STEP 10

- Remove the hoop from the machine, but NOT the project from the hoop.
- Trim away the excess fabric close to the stitching line.
- Note: if the outer stitching line is cut, the second (inside) line will hold the applique in place.

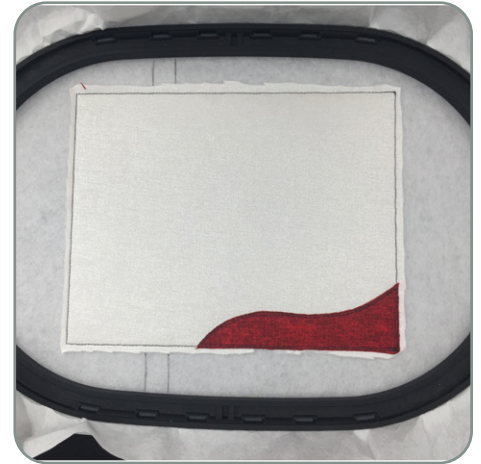

STEP 11

- Return the hoop to the machine.
- Stitch Machine Steps 5-8 to add the other corner applique and the gingerbread man applique.
- Note: Use steps 8-10 in the instructions for reference.



STEP 12

- Stitch Machine Steps 9-16, changing threads per the thread chart.



STEP 13

- Remove the hoop from the machine, but NOT the project from the hoop.
- Position the smaller folded fabric (7" x 3" fold measurement) over the bottom of the design, aligning the folded edge with the top side placement line as shown.
- Position the larger folded fabric (7" x 6" folded) over the top of the design aligning the folded edge with the bottom side placement line so that the two fabrics overlap.
- Tape to secure.
- TIP: By overlapping the two fabrics in the listed order will prevent the embroidery foot from catching on the overlapped edge of the fabric.
- Note:
 - After folding 7" x 12" will measure approximately 7" x 6".
 - After folding 7" x 6" will measure approximately 7" x 3".

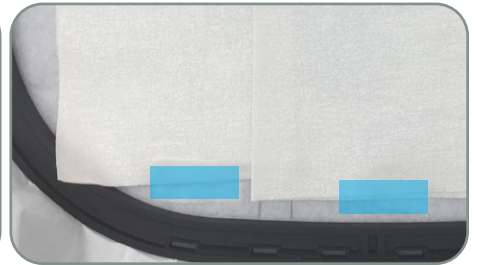
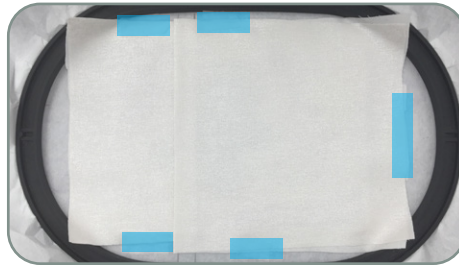

STEP 14

- Stitch Machine Step 17, Seam.

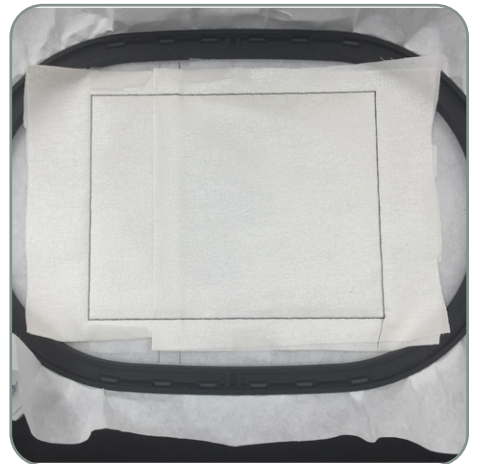

EMBROIDERY



STEP 15

- Remove the hoop from the machine and the project from the hoop.
- Tear away excess stabilizer.
- Trim the outer edges 1/4" from the seam stitch on all four sides.
- Clip each corner diagonally.



STEP 16

- Turn the mug rug inside out.
- Use the Expert Point and Press Tool to push out the corners and side seams.
- Press right side down on a Perfect Embroidery Press Cloth.
- The mug rug is complete!



CUP COZY SUPPLIES



Stabilizers

- OESD Medium Weight TearAway
- OESD Fuse and Fleece
- OESD Fuse and Seal

Fabrics/Textiles

- Red cotton fabric (2) 4" x 10"

Notions & Tools

- Isacord thread per thread chart
- OESD Expert Embroidery Tape TearAway
- OESD Expert Point and Press Tool
- OESD Perfect Embroidery Press Cloth
- Embroidery Needle Sharp 75/11
- 1/8" Elastic, 4" long
- 1 Button

Isacord Thread Colors

- Per thread chart

EMBROIDERY



NOTE

- The cup cozy instructions included in the design pack are general instructions for the designs. For demonstration purposes, the following instructions are for a sample design that best demonstrates the techniques. Refer to the thread chart for each specific design.
- The sample design is 12882-08.
- Note: Some thread colors in instructions have been changed or digitally enhanced for better visibility.

STEP 1

- Apply Fusible Woven to the wrong side of both pieces of red fabric following the package instructions.

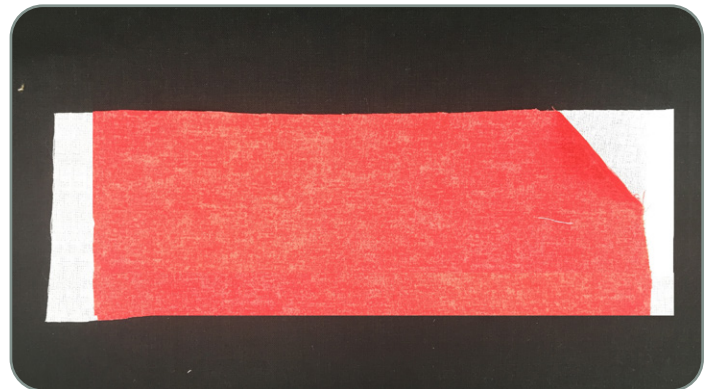

STEP 2

- Cut a piece of 1/8" elastic 4" long.

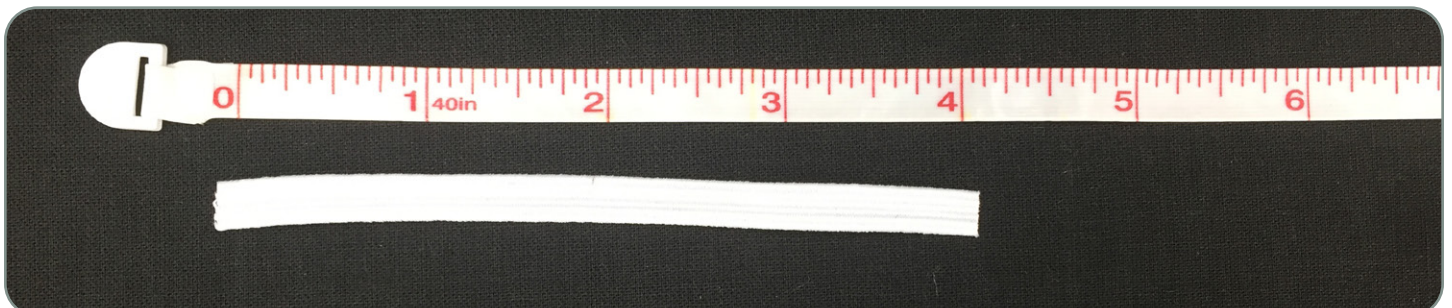

EMBROIDERY



STEP 3

- Hoop one layer of Medium Weight TearAway.
- Place the hoop on the machine.



STEP 4

- Stitch Machine Step 1, Red Fabric Placement Stitch.



STEP 5

- Remove the hoop from the machine, but NOT the project from the hoop.
- Position one piece of the prepared red fabric, right side up, over the placement stitch.
- Tape to secure.

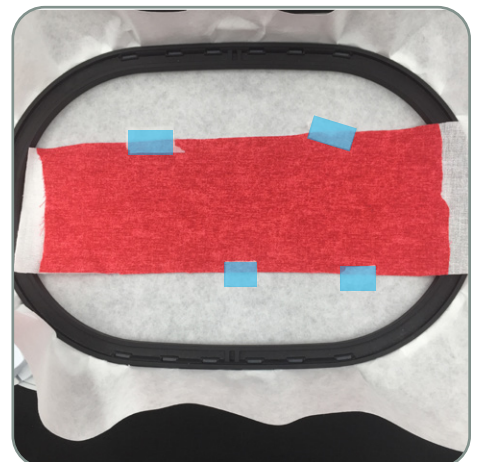

EMBROIDERY



STEP 6

- Return the hoop to the machine.
- Stitch Machine Steps 2-6, changing threads per the thread chart.
- Stop before Machine Step 7, Seam.

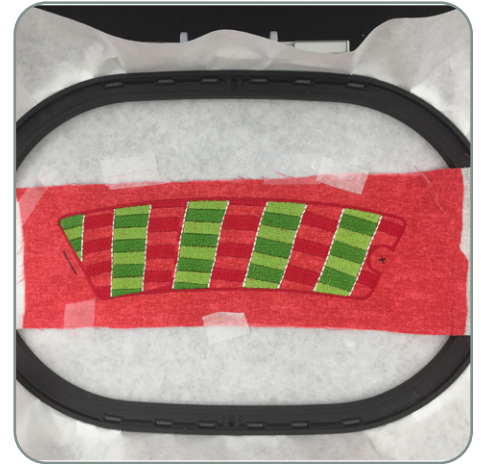

STEP 7

- Remove the hoop from the machine, but NOT the project from the hoop.
- Fold the elastic in half and position on the placement line as shown with the fold of the elastic toward the center of the design.
- Tape to secure.

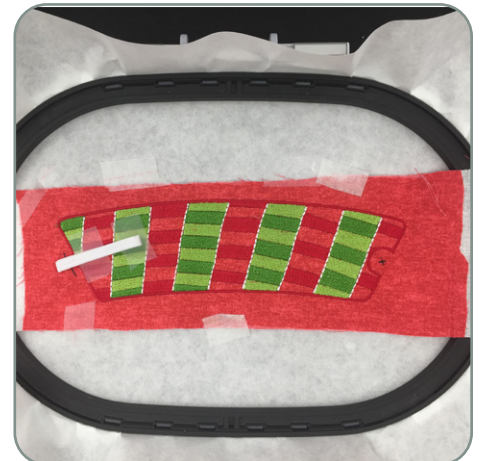

STEP 8

- Place the other piece of red fabric face down completely covering the stitched design.
- Tape in place to secure.
- Return the hoop to the machine.

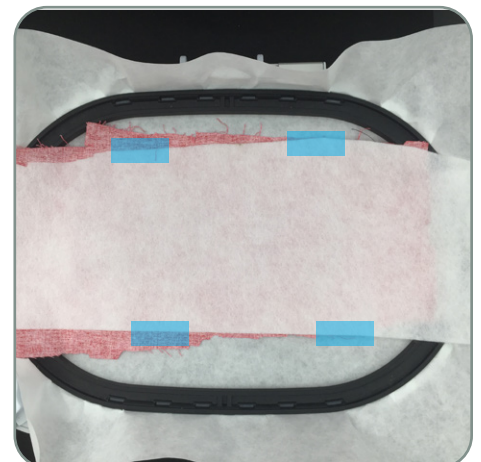

STEP 9

- Stitch the final Machine Step 7, Seam.



STEP 10

- Remove the project from the hoop and tear away the excess Medium Weight TearAway stabilizer.
- Do not cut off the neck opening at the top. Trim across above the vertical lines of stitching. Clip each inner corner to, but not through, the stitches in the corner.
- Turn project right side out.
- Use the Expert Point and Press Tool to push out the seams and corners.

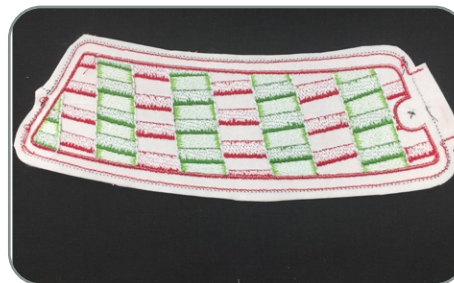

STEP 11

- Tuck neck into the opening.
- Press, embroidery side down on a Perfect Embroidery Press Cloth
- Close the opening with a piece of OESD Fuse and Seal.
- Attach a button over the button placement guide.
- The Cup Cozy is complete!

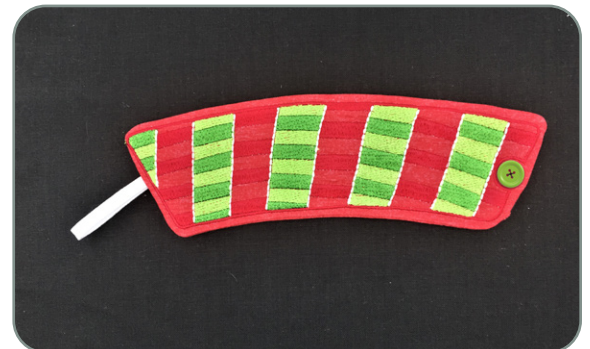

ATTENTION

When printing this document, any page scaling or page fitting options in your print dialog box must be turned OFF or set to NONE so that your files will print out at their actual size. Images not printed at actual size will not function as intended.

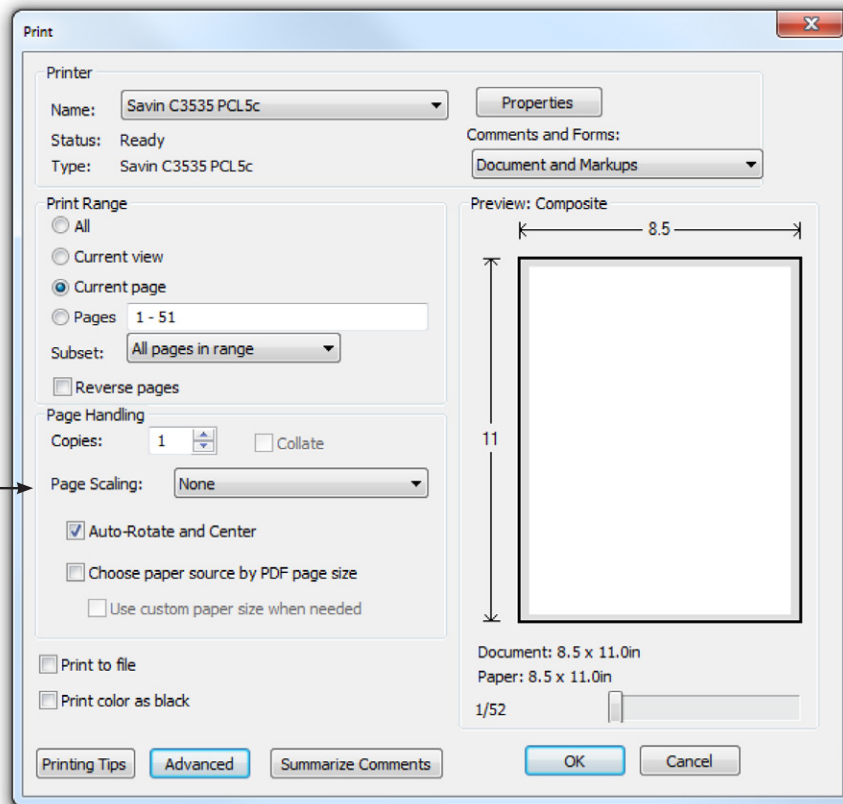

TO SAVE PAPER

Only print the desired image by navigating to the image's page, go to File > Print and select "Current page" in the print dialog box. Repeat for each desired image.

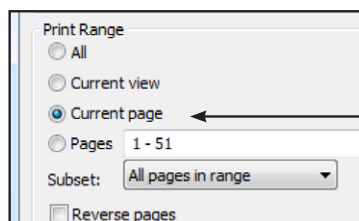

APPLIQUE PATTERNS



Print at 100%. No scaling. This box measures 1" x 1". Use the box as an accuracy guide when printing templates.

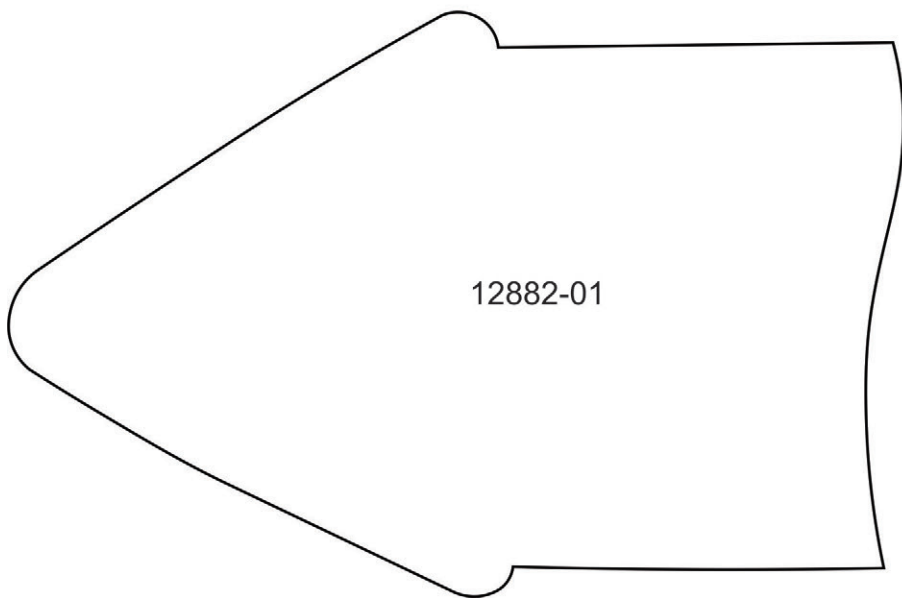

12882-01

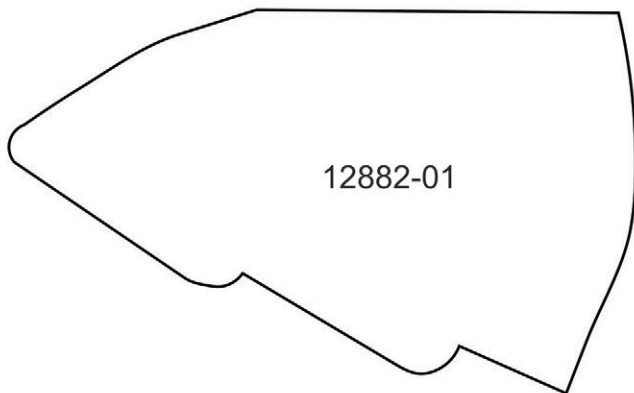

12882-01

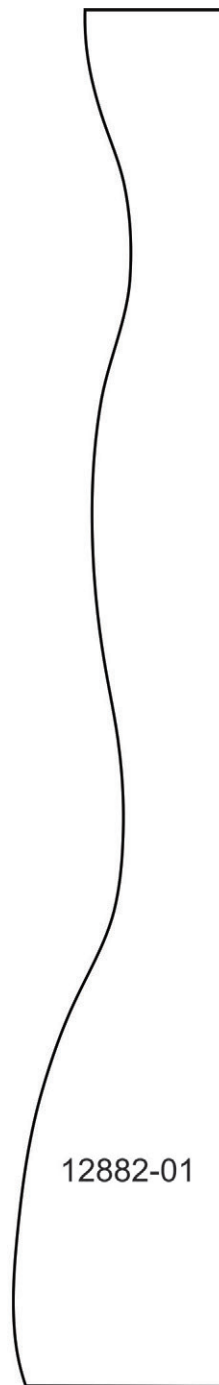

12882-01

APPLIQUE PATTERNS



Print at 100%. No scaling. This box measures 1" x 1". Use the box as an accuracy guide when printing templates.

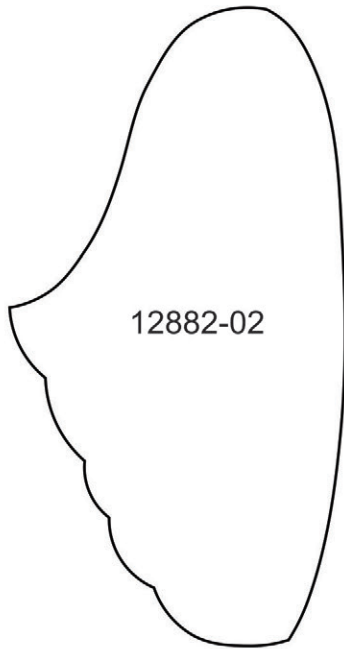

12882-02

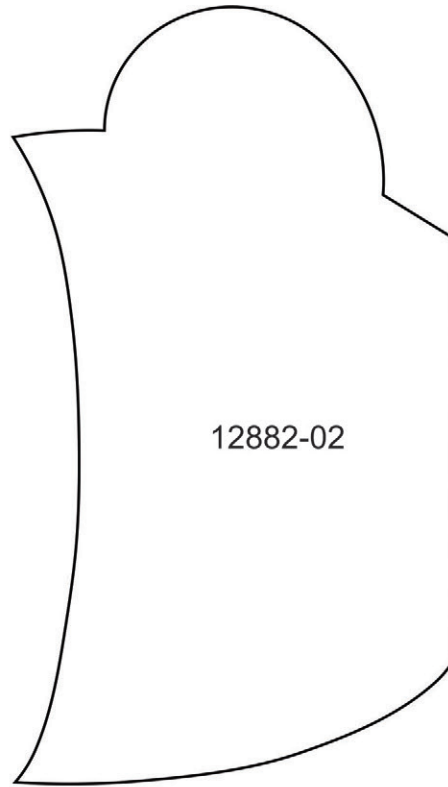

12882-02

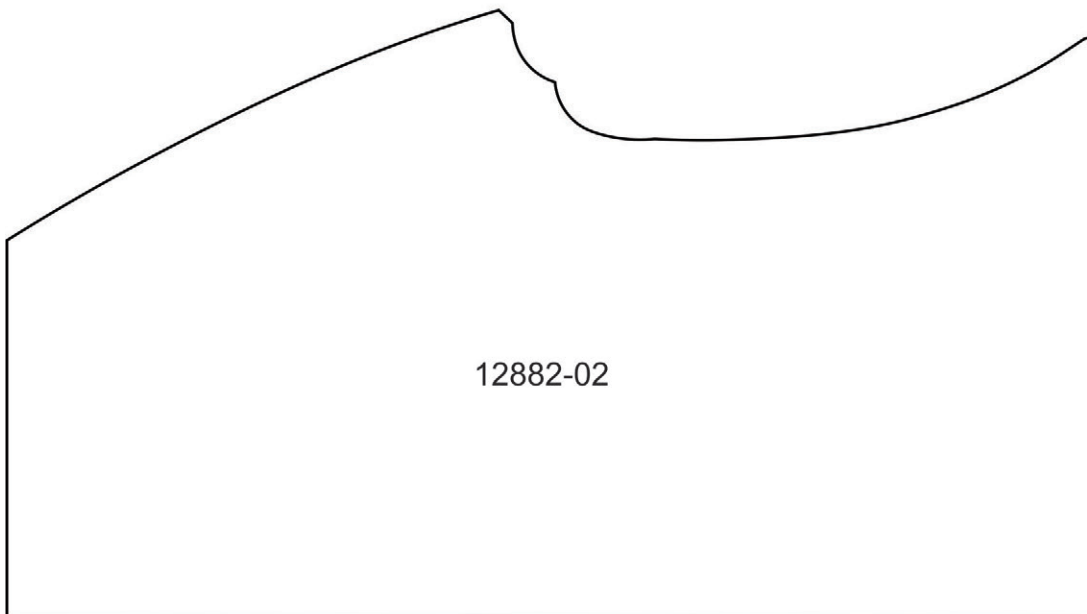

12882-02

APPLIQUE PATTERNS



Print at 100%. No scaling. This box measures 1" x 1". Use the box as an accuracy guide when printing templates.

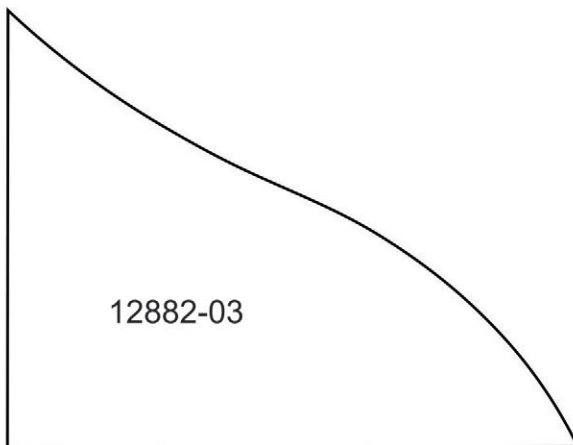
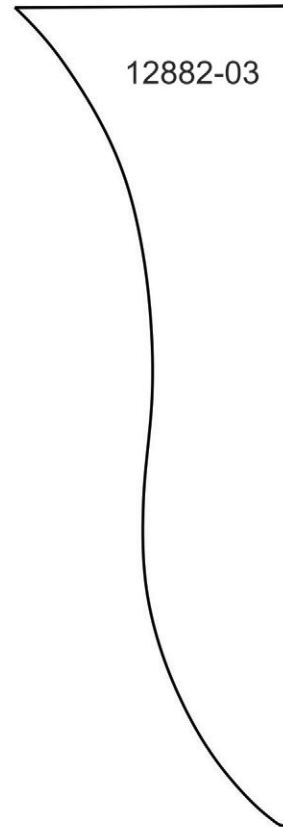
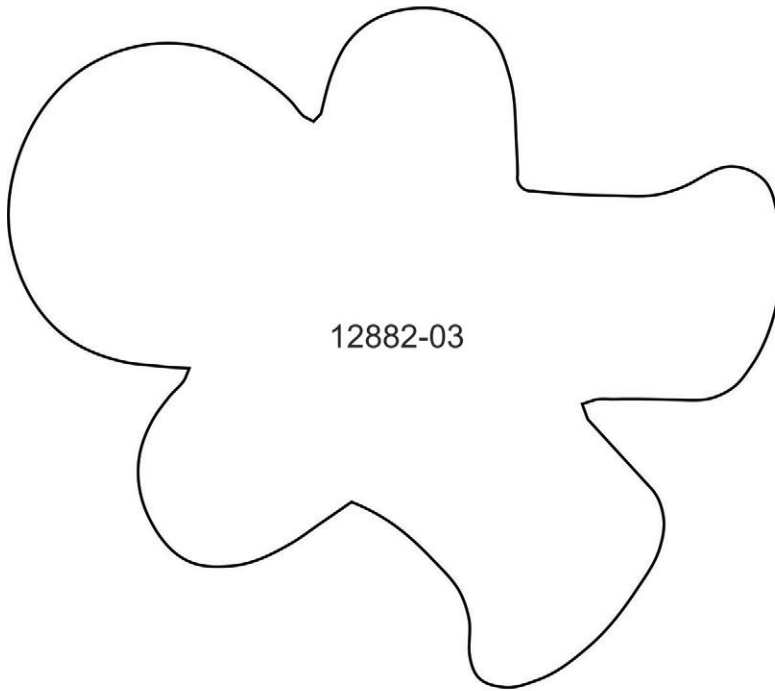

APPLIQUE PATTERNS



Print at 100%. No scaling. This box measures 1" x 1". Use the box as an accuracy guide when printing templates.

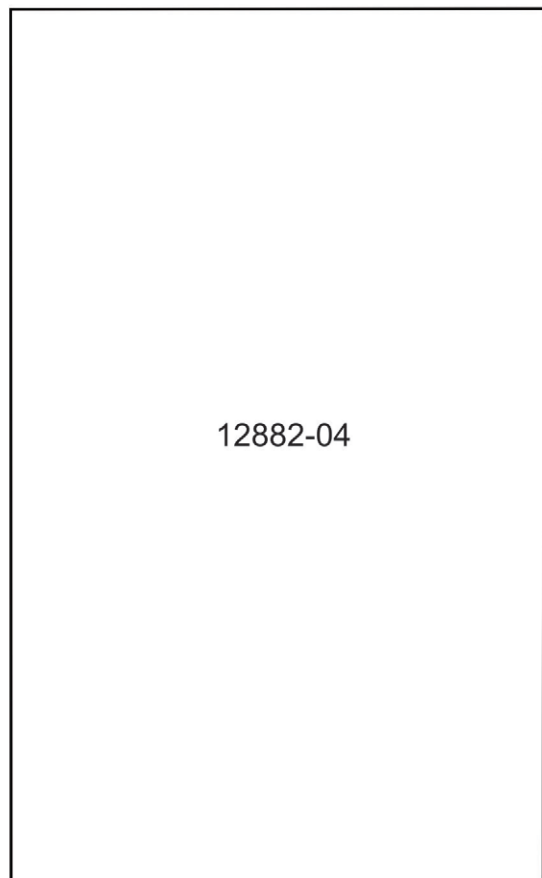
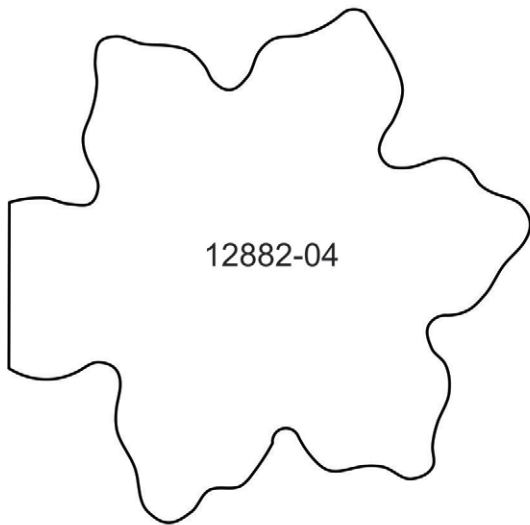
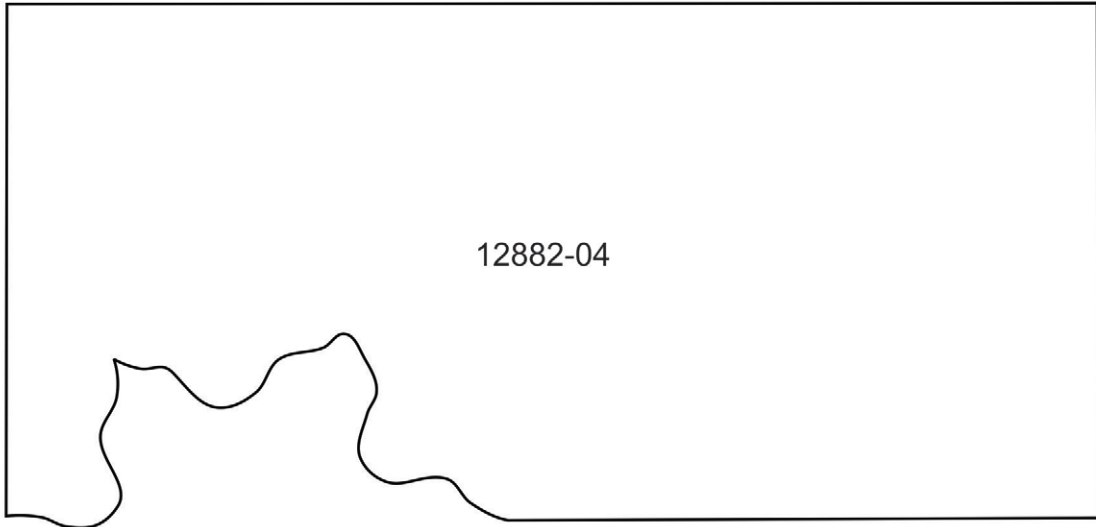

APPLIQUE PATTERNS



Print at 100%. No scaling. This box measures 1" x 1". Use the box as an accuracy guide when printing templates.

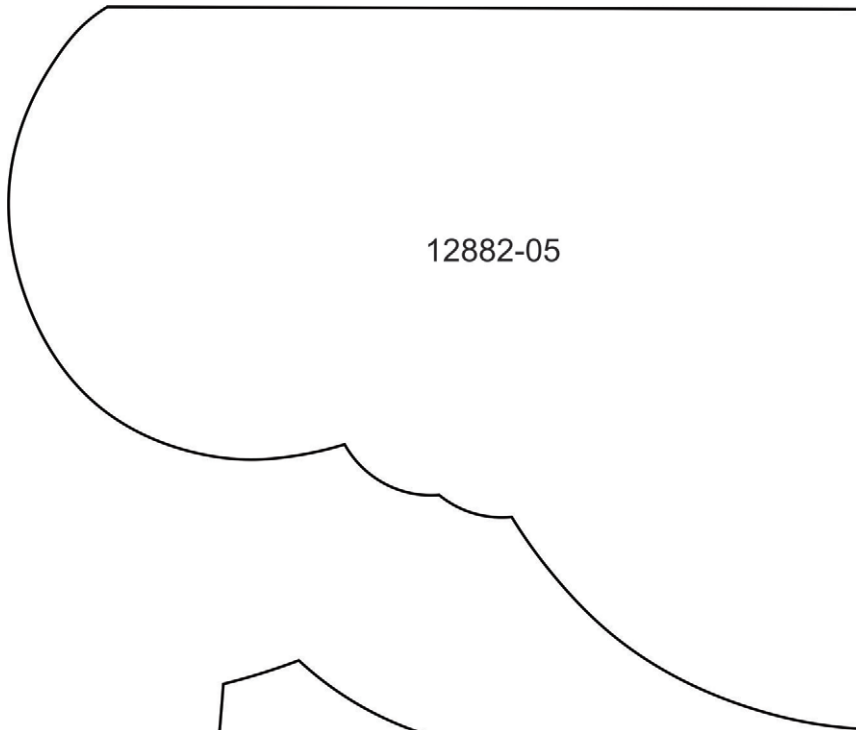

12882-05

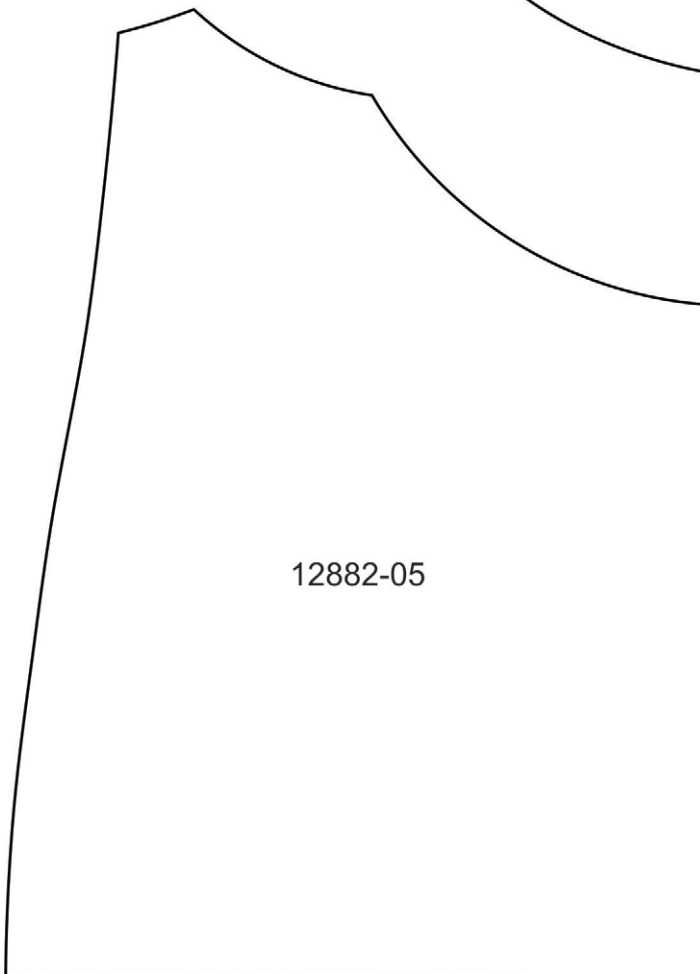

12882-05

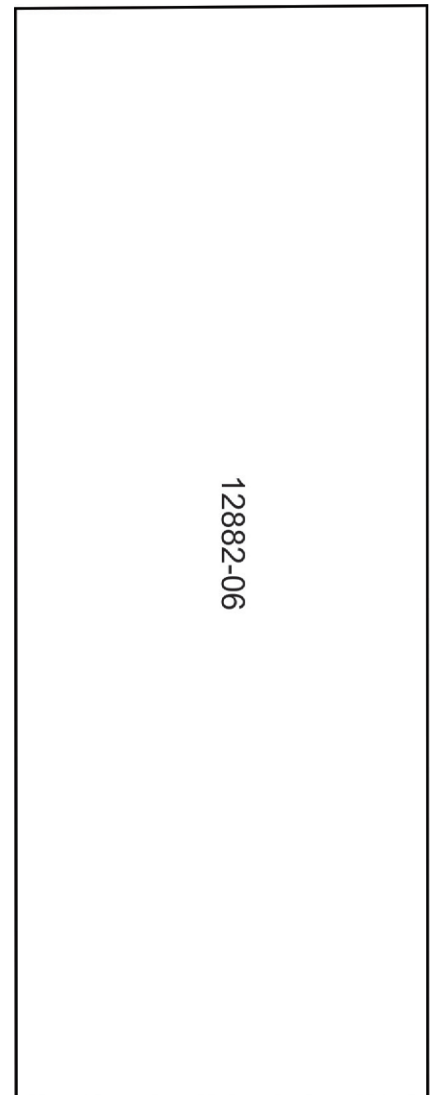

12882-06

MIRRORED PATTERNS



Print at 100%. No scaling. This box measures 1" x 1". Use the box as an accuracy guide when printing templates.

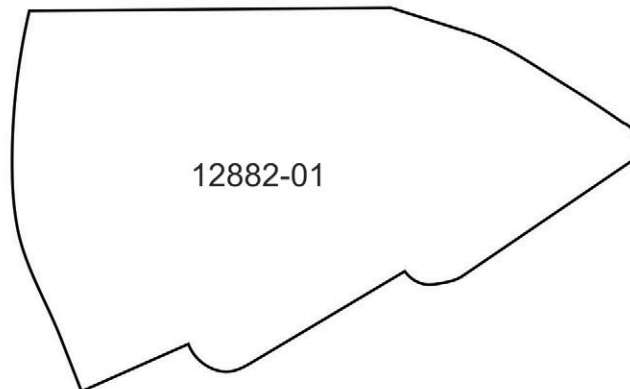
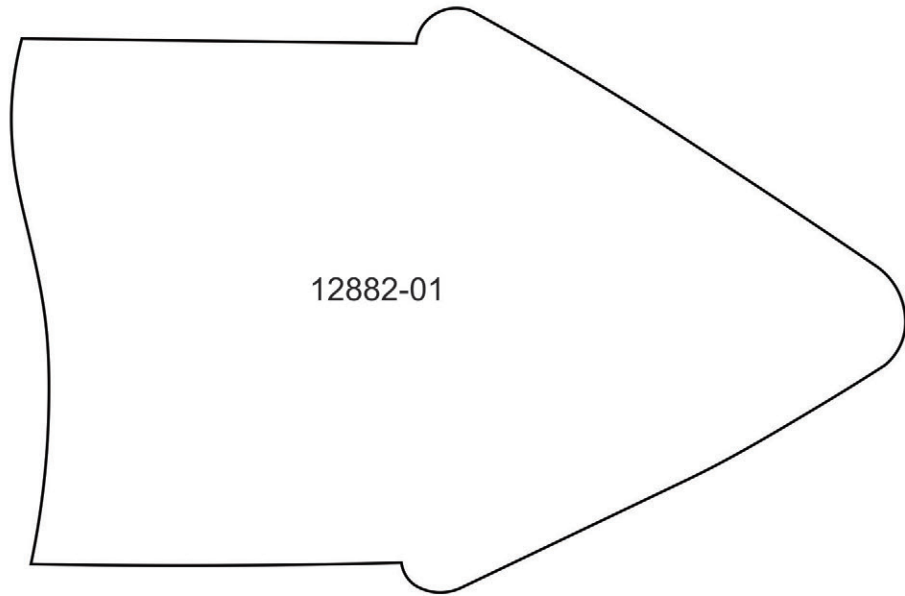
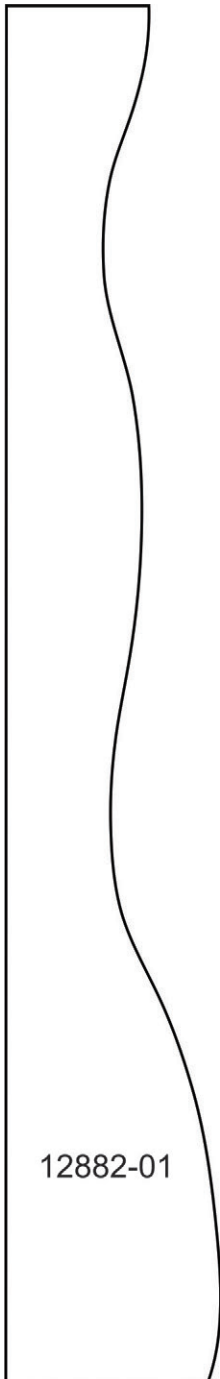

MIRRORED PATTERNS



Print at 100%. No scaling. This box measures 1" x 1". Use the box as an accuracy guide when printing templates.

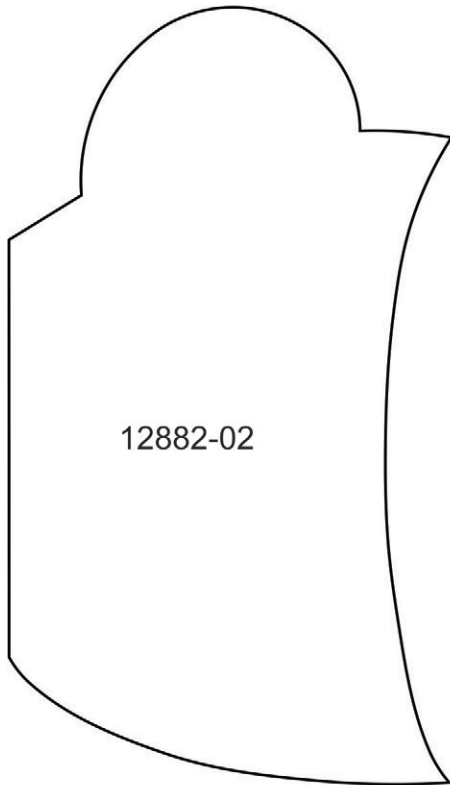

12882-02

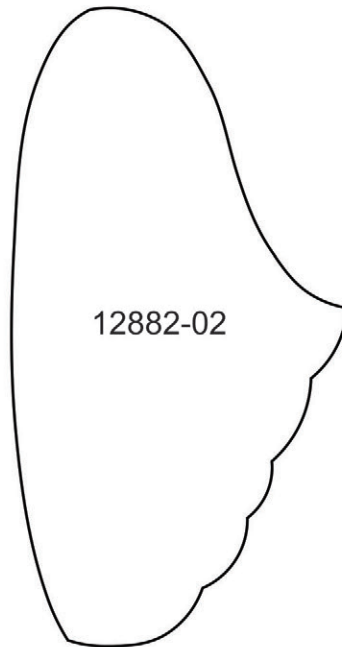

12882-02

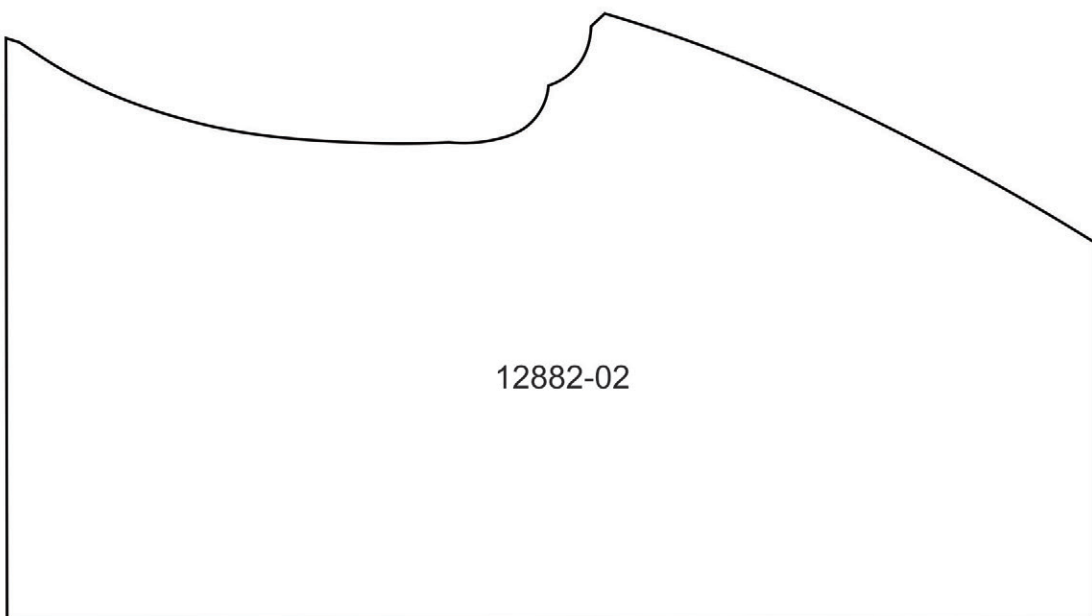

12882-02

MIRRORED PATTERNS



Print at 100%. No scaling. This box measures 1" x 1". Use the box as an accuracy guide when printing templates.

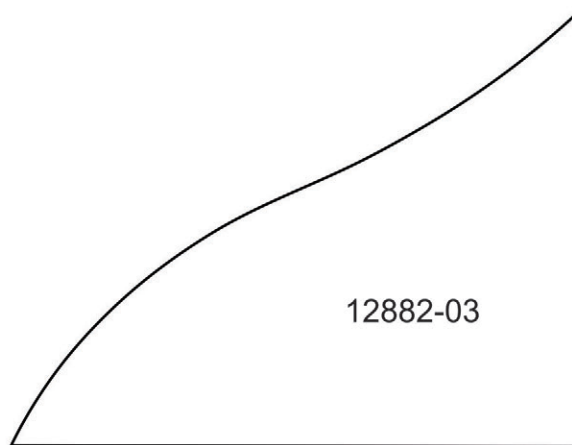
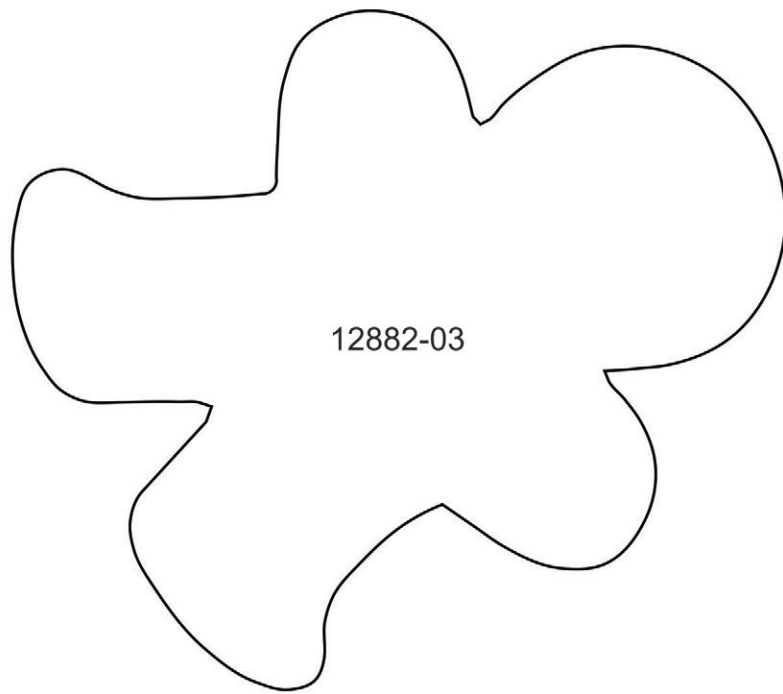
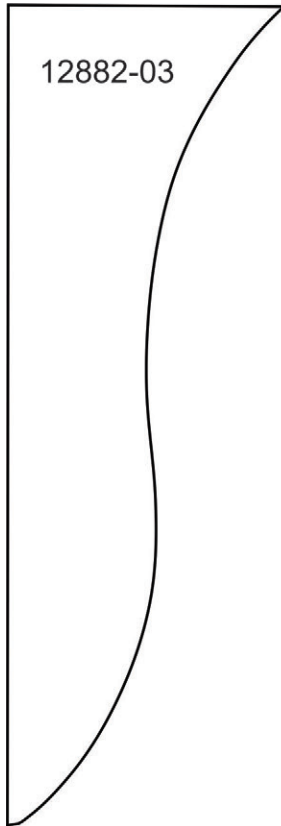

MIRRORED PATTERNS



Print at 100%. No scaling. This box measures 1" x 1". Use the box as an accuracy guide when printing templates.

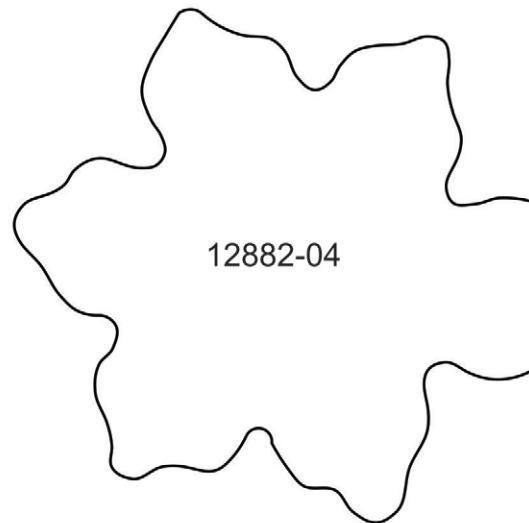
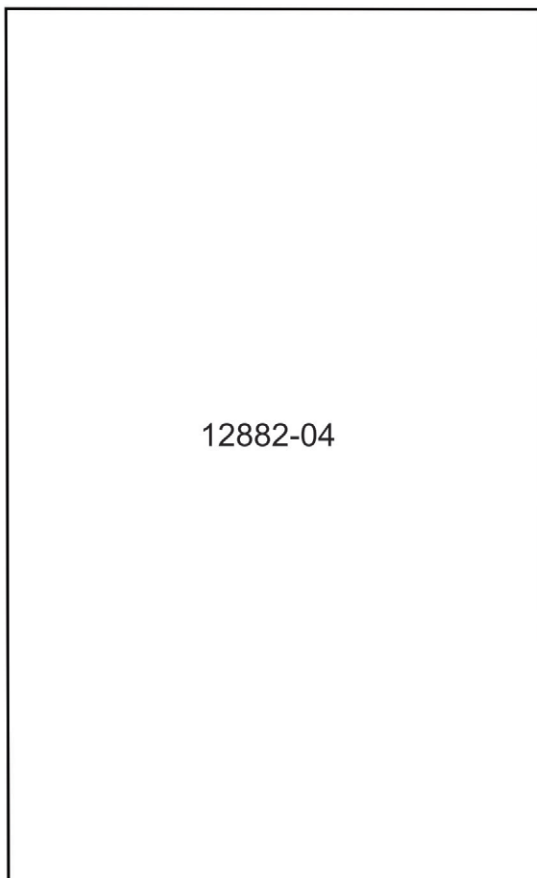
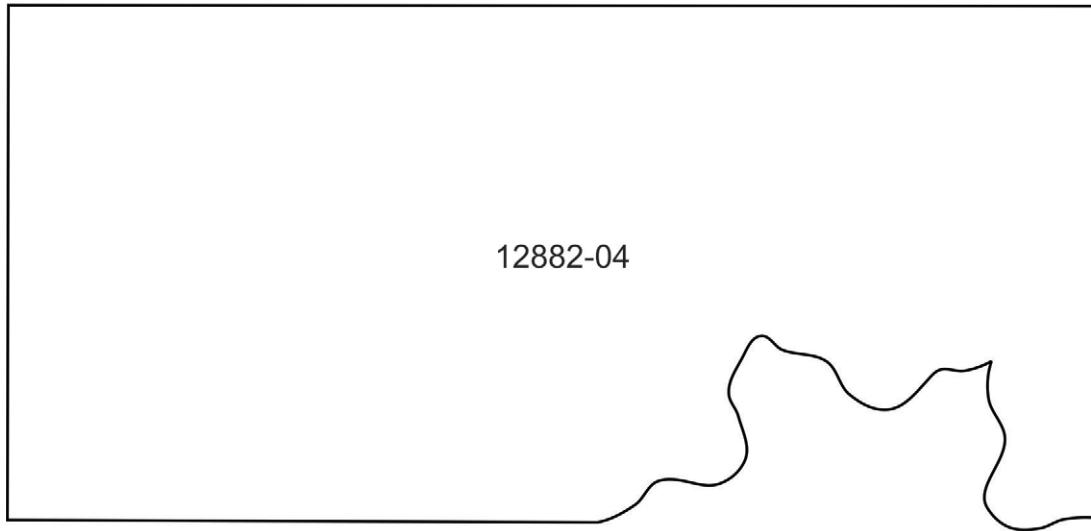

MIRRORED PATTERNS



Print at 100%. No scaling. This box measures 1" x 1". Use the box as an accuracy guide when printing templates.

