



DISCOVERY
DLS

OWNER'S MANUAL





PRODUCT INFORMATION

Unit & Parts.....4

PRODUCT INSTALLATION

Seat Installation.....5

Remote Installation.....8

PRODUCT OPERATION

Functions & Settings.....10

Maintenance.....14

Warranty.....16

Specifications.....18

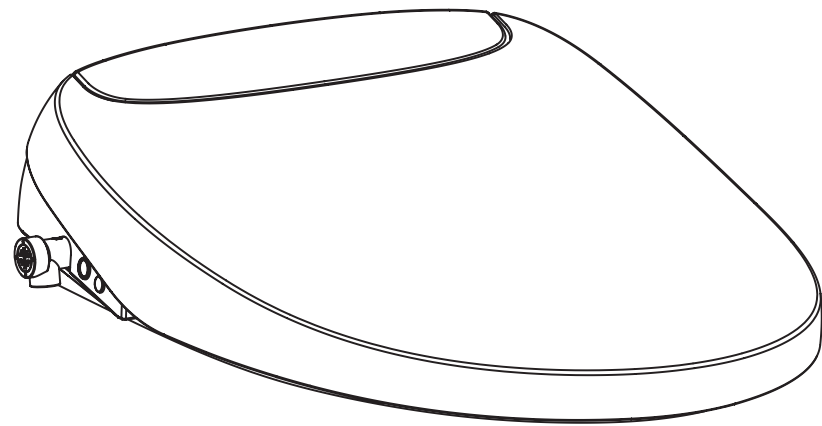

DLS BIDET SEAT

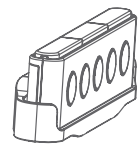

REMOTE CONTROL



AAA BATTERY X2

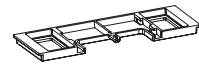

CATCH PLATE

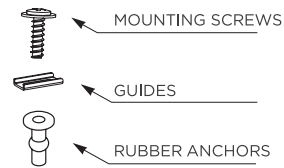

INSTALL SCREW ASSEMBLY



T-VALVE (WITH RUBBER GASKET)



1/2" CONVERSION NUT (OPTIONAL)

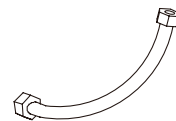

BIDET HOSE (1/2" to 1/2")

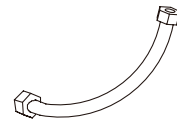

TOILET HOSE (7/8" to 3/8")

1. Attach Rubber Anchors

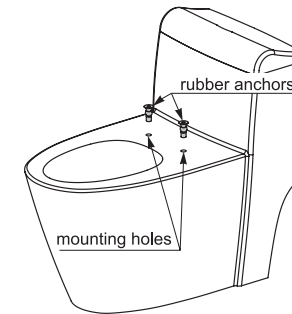

Remove the existing toilet seat and insert the rubber anchors into the mounting holes.

2. Attach the Mounting Plate

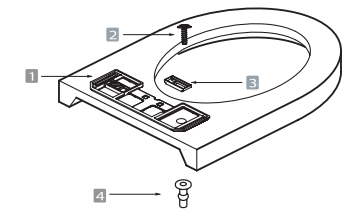

1 mounting plate 2 mounting screw 3 guide 4 rubber anchor

Place the catch plate and guides over the mounting holes. Insert the mounting screw and secure the catch plate to the toilet.

3. Attach the Bidet Seat

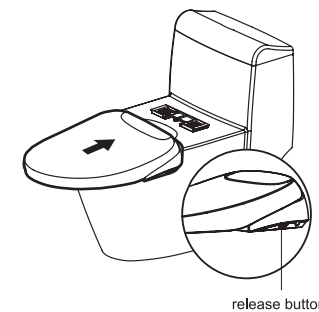

Slide the bidet seat all the way on to the catch plate. You will hear a click once the product is securely mounted to the catch plate.

4. Seat Sensor

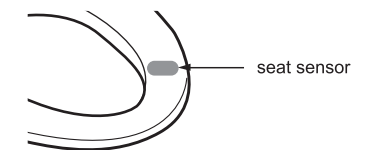

This appliance is equipped with a seat sensor and will not function unless it is occupied.



5. Connect the Water Hose

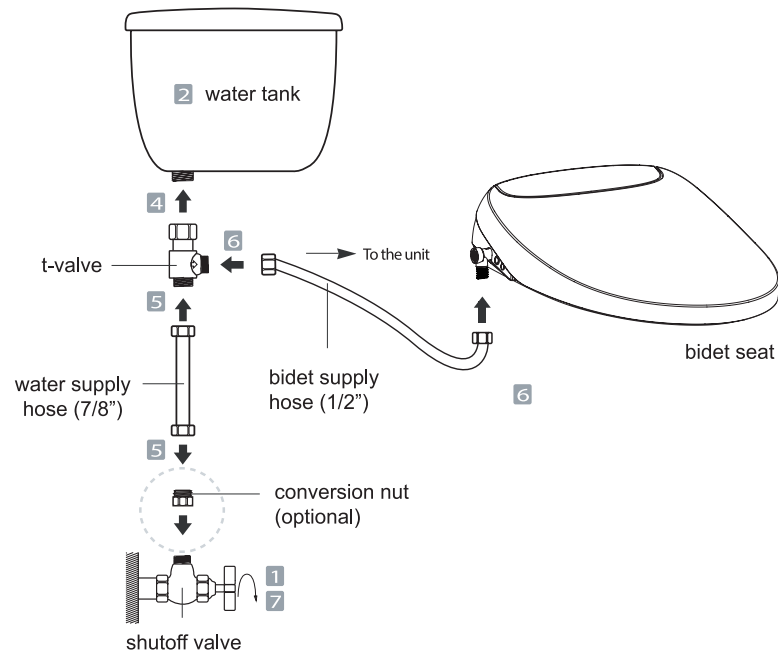

1. Close the water shutoff valve.
2. Flush the toilet to empty the tank.
3. Remove the existing water supply hose from the tank.
4. Install the t-valve on to the tank. Ensure the rubber gasket is properly seated inside the T-Valve.
5. Connect the 7/8" water supply hose to the water shutoff valve and t-valve. If necessary, use the included conversion nut.
6. Connect the 1/2" water supply hose to the bidet seat and t-valve.
7. Open the water shutoff valve.
8. Check for any leaking or dripping.

6. Plug it in!

- Plug the power cord into a 120V power outlet.
- Please contact our service center at 847-458-2334 if you have any questions.



1. Installation

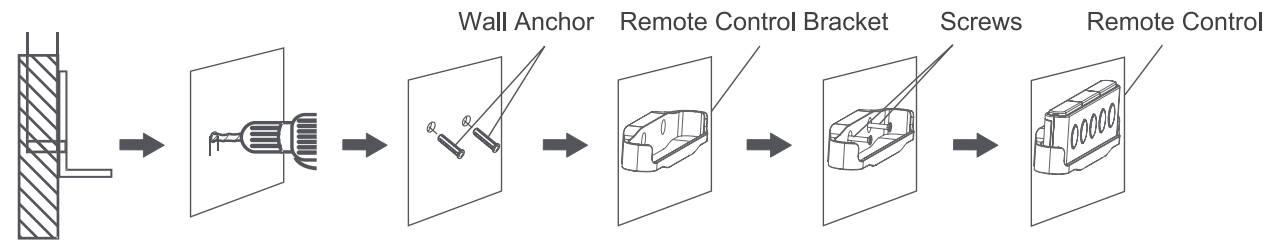

- Drill two 6mm holes on the wall that line up with the remote bracket.
- Install the wall anchors in the newly drilled holes.
- Place the remote bracket over the wall anchors.
- Use the provided screws to attach the remote control bracket to the wall.
- Place the remote control on the bracket.

2. Remote Pairing

(Follow these instructions if the bidet seat is not responding to the remote)

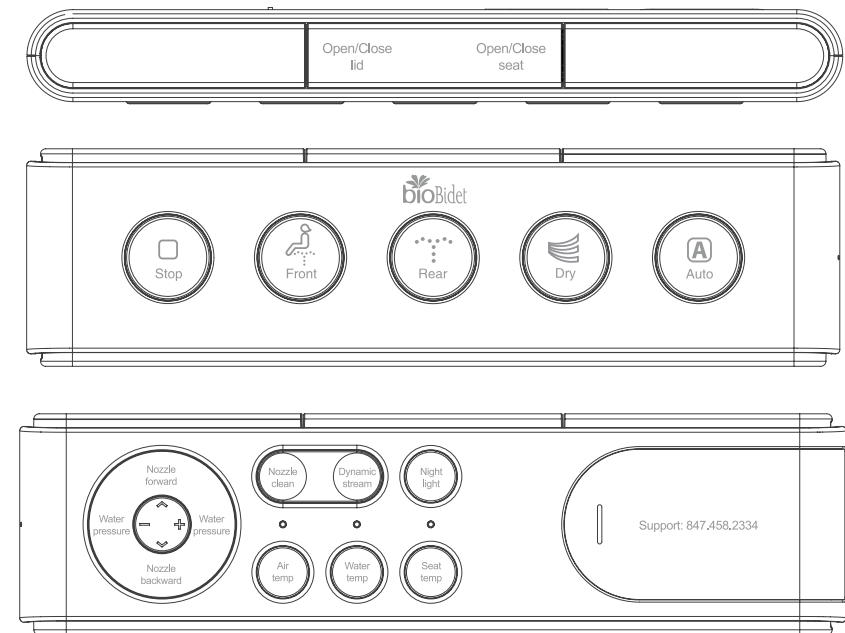

- Unplug the bidet seat.
- Press and hold the “STOP” button on the remote until the indicator lights flash.
- Hold the remote close to the bidet seat and plug it back in.
- The indicator lights will stop flashing when the remote has successfully paired.



Turn On The Seat

- Press the Power Button on the side of the seat.

Pre Nozzle Rinse

- As soon as the seat sensor is activated, a pre-rinse cycle will begin. This process rinses the nozzle in preparation for a wash function. Water will drain into the bowl during this time.

Turn Sounds On/Off

- Press and hold the night light button for 3 seconds to turn beeping sounds on/off.

OPEN/CLOSE COVER*

Press to open or close the lid.

OPEN/CLOSE SEAT*

Press to open or close the seat.

*Press and hold the nozzle cleaning and dynamic stream buttons for 3 seconds to turn the automatic open function on/off.

NIGHT LIGHT

Press to turn the night light on/off.

FRONT

Press to activate the oscillating front wash.
Press again to turn off oscillation.

REAR

Press to activate the oscillating rear wash.
Press again to turn off oscillation.

STOP

Press to stop any operations.

DRYER

Press to activate the warm air dryer.
Press again to adjust the fan speed.



WATER TEMP. | AIR TEMP. | SEAT TEMP.

Press the corresponding buttons to adjust the temperature settings on each feature.

- **Low** - Blue
- **Medium** - Purple
- **High** - Red

WATER PRESSURE

The water pressure starts off low. Press the + or - buttons to adjust the water pressure accordingly.

NOZZLE POSITION

Press the arrow keys to adjust the position of the nozzle accordingly.

DYNAMIC STREAM

Press during a wash to quickly alternate between hot and cold water. This feature assists in stimulating bowel movements.

NOZZLE CLEAN

Press to extend the nozzle for manual cleaning. This feature can only be activated when the seat is not occupied.

ULTRAVIOLET STERILIZATION

This feature automatically activates after a wash cycle. The seat cannot be used during this time. This feature can only be activated when the seat is not occupied.

POWER/STOP BUTTON

Short press to power on or long press to enter standby mode. Short press while powered on to stop any operations.

- When the power button is **red**, it is in UV sterilization mode or in use.
- When the power button is **blue**, it is ready to use.

AUTO CLEAN

Press to activate a rear wash for 90 seconds, followed by the dryer function for 4 minutes. Pressing the Auto button a second time during the wash will skip ahead to the dryer function.

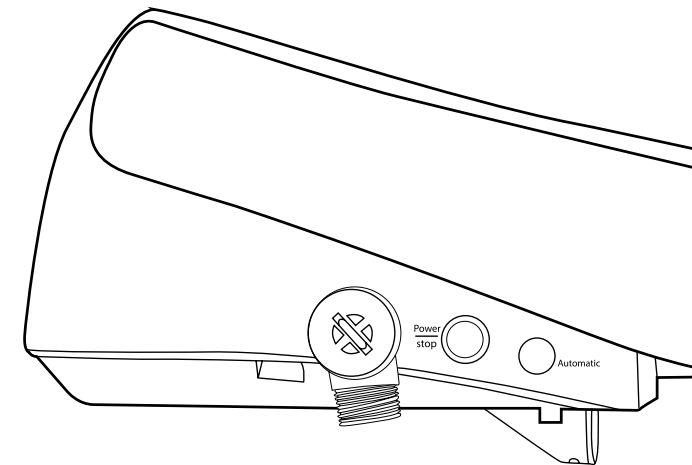



Cleaning the Unit

- Disconnect the power plug and wipe the seat with a dry or damp cloth using a neutral cleaning solution.
- Do not spray water directly on this product.
- Do not use harsh cleaning chemicals, as those can cause damage or discoloration.

Extended Travel

When the seat will not be used for more than a few days, it is recommended to unplug the unit and turn off the water shutoff valve.



5 Year Premier Warranty Coverage

Bio Bidet warrants the DLS Discovery to be free from manufacturing defects under normal use for a period of 5 years from the date of purchase.

Our obligation to you under this warranty is limited to repair or replacement, at our option, of defective products or parts, provided the products were properly installed and used in accordance with the instructions. We reserve the right to make inspections in order to determine the cause of the defect. We will not charge for labor or parts in connection with warranty repairs or replacements. We are not responsible for the cost of removal, return shipping, and/or reinstallation of products.

This warranty does not apply to:

- a. Damage or loss from a fire, earthquake, flood, storm, etc.
- b. Damage or loss resulting from any unreasonable use, abuse, negligence, or proper maintenance.
- c. Damage or loss from improper installation, removal, repair, or modification.
- d. Damage or loss resulting from sediment or other matters contained in your water system.

This warranty gives you specific legal rights.

For warranty service information, please contact your dealer or Bio Bidet.

Only the original purchaser may submit a claim under this warranty.

This warranty is our only warranty covering your product. Repair or replacement as provided under this warranty shall be the exclusive remedy available to you. We shall not be responsible for loss of the product or for other incidental, or consequential damage or expenses you may incur for labor or other costs due to installation or removal, or cost of repairs by others, or for any other expense not specifically stated above. Except to the extent prohibited by applicable law, any implied warranties, including that of merchantability or fitness for use, are expressly limited to the duration of this warranty.

WARNING! We are not responsible or liable for any failure of, or damage to, this plumbing product or product component caused by in-tank bowl cleaners containing chlorine (calcium hypochlorite).

Note: The use of high concentration chlorine related products can damage the product fittings. This damage can cause leakage and serious property damage.



Model	Discovery DLS	Rated Power	1050W
Rated Voltage	120V, 60Hz	Waterproof Guide	IPX4
Seat Temp	Off / 93.2-102.2°F	Water Temp.	Off / 95 ~ 102.2°F
Product Dimensions	20.79" x 16.38" x 5.59"	Ambient Temp Requirement	102.2° F
Water Heating	Instant	Air Temp	102.2° F

Warning

- The product must be reliably grounded. Otherwise, electric shock may be caused by fault or short circuit. When in doubt, contact the electrical installation company.
- Do not touch or plug the power plug with wet hands. Otherwise there is the risk of electric shock.
- Do not use defective power outlets or damaged power plugs. Otherwise, poor contact and damage will lead to electric shock or fire hazard.
- Please use the power socket within the specified range (ac 120V±10%, maximum current above 10A). Otherwise easy to cause fire, electric shock.
- Do not pull, break, bend or twist the power cord at will, stretch, crimp, bundle, load bearing or over squeeze. Otherwise, damaged power lines may lead to electric shock or fire.
- If the power cord is damaged, it must be replaced by a professional from the manufacturer, its maintenance department or similar department to avoid danger. Otherwise easy to cause electric shock, fire.
- Do not use industrial water or contaminated water sources. Otherwise it is likely to cause cystitis, dermatitis and internal corrosion of machinery will cause electric shock, fire.
- Please avoid installation in damp and easily soaked bathroom. Do not spray water on the product or rinse it with water, in case of internal water flooding and loss. Otherwise easy to cause electric shock, fire.
- Do not put lit cigarettes and other incendiary materials into the intelligent toilet lid. Otherwise fire is likely to happen.
- Do not use in lightning weather (in the vicinity of lightning, please unplug the power plug). Otherwise, an accident or malfunction may occur.
- In case of damage to the seat and cover plate, in order to avoid danger, please be sure to remove the power plug, turn off the water source, and contact the local dealer for replacement. Otherwise easy to happen electric shock, fire danger.
- Please pull out the power plug regularly and wipe the dust on the power plug with dry cloth. Otherwise, when the insulation is poor, it will cause a fire.



- Persons (including children) with physical, perceptual, intellectual disabilities or lack of experience and common sense are requested to use the product in the company of someone. Otherwise use for a long time, may cause low temperature burns.
- Children should not play with this product. Otherwise it may cause personal injury.
- It is forbidden to disassemble, repair or modify the product if it is not the after-sales maintenance personnel or the designated professional maintenance personnel. Otherwise, it is easy to cause electric shock, fire or abnormal operation and cause personal injury.
- Do not urinate into the warm air outlet. Otherwise there is the risk of electric shock.
- Do not put your hands or other things into the warm air outlet. Do not cover the warm air outlet when using the product. Otherwise, it is easy to cause electric shock, fire or abnormal operation and cause personal injury.
- Cleaning and maintenance of plastic parts, please do not use inappropriate cleaner (such as sulfuric acid, nitric acid, glacial acetic acid, carbon tetrachloride, chloroform, acetone, butanone, benzene, toluene, phenol, cresol and dimethyl formamide, methyl ether, soybean oil, 95% acetate, 40% nitric acid and concentrated hydrochloric acid, alcohol, gasoline, kerosene, brake oil, etc.) Otherwise, the plastic may crack, causing personal injury, electric shock or fire.
- Please do not force back, stand on the cover plate, or roughly open and close the cover plate, seat ring, to avoid damage. Otherwise, it is easy to damage and cause personal injury.
- Do not add water or detergent to the inside of the smart toilet seat. Do not wet intelligent toilet lid and power plug with water or detergent.

Attention

- Do not use the “high” or “medium” range of seat temperature, warm air/wind temperature for a long time. Otherwise, there will be the risk of burns if used for a long time.
- During use, keep the skin close to the sensing area of the seat, otherwise the product will stop cleaning or warm air drying. It can be difficult for children to touch the sensing area.
- Do not pour urine on the nozzle of the washer. Otherwise it creates dirt and causes clogging.
- Please use the new hose assembly that comes with this machine. The old one cannot be reused. If it is equipped with other appliances connected to the water source, please replace them as well. Otherwise, it is easy to cause water leakage and property loss.
- When sudden power failure, please unplug the power plug, close the Angle valve, to prevent leakage. Otherwise, it is easy to cause water leakage and property loss.
- Please avoid direct sunlight or keep heating equipment near this product. Otherwise it may cause discoloration of the product.
- In order to avoid the danger caused by the wrong resetting of the thermal circuit breaker, do not supply power through external switching devices, such as timers or circuits connected to regular on-off or off-off by common components.
- Be sure to turn off the water supply Angle valve when removing strainer. Tighten the strainer firmly when installing it. Otherwise easy to cause water leakage.
- When it is not used for a long time, such as business trip or travel, please be sure to remove the power plug, close the water source, and drain the internal water. Otherwise, damage caused by frozen internal water can lead to fire and water leakage.
- During the cold winter months, when products are transported long distances or stored for a long time, the remaining water in the products may freeze. To prevent damage caused by freezing, please take anti-freezing measures. Otherwise, damage caused by frozen internal water can lead to fire and water leakage.
- In the same room where this product is installed, a water stop valve shall be installed at a convenient position to cut off the inlet water of this product in case of emergency without the help of tools. Otherwise, unexpected failure of the product may lead to loss of users.



- Please do not pour newsprint, paper pad, sanitary napkin and other easily blocked articles into the toilet.
- Please do not use in the environment below 0°C.
- Do not hit the ceramic with gravity to prevent damage and leakage.
- Please do not insert cementing materials (cement mortar, etc.) in the base of the toilet to prevent cracking due to expansion.
- Please use the battery correctly according to the following methods.
- Please press plus or minus to install the battery correctly; Remove the battery when not in use for a long time. Battery power depletion will affect signal reception, please replace the battery in time; When the battery is discarded, please use tape to insulate it. Please place the battery out of the reach of infants; When the electrolyte touches the body, please wash it with clean water. Do not rub your eyes if the electrolyte accidentally enters your eyes. Rinse with water immediately and seek medical advice immediately.
Otherwise, fluid from the battery could cause a fire.
If swallowed, seek medical advice.
Otherwise it is easy to cause blindness.
- Do not do the following when using the battery.
- Do not carry or keep with metal products (necklaces, watches, etc.);
Do not mix old and new batteries;
Do not decompose the battery or put it into water or fire.

Thank You



Technical Support/Customer Service
7900 S Route 31 Crystal Lake, IL 60014
T: 847.458.2334
TOLL FREE: 877.339.5214

support@biobidet.com
www.biobidet.com