



Flex 6EX2 System

Radio Control Equipment Instruction Manual



MAGNETEK
MATERIAL HANDLING
ENRANGE

Part Number: 191-50600-M000F R00
November 2017

©Copyright 2017 Magnetek Material Handling

Distributed by Ergonomic Partners
Sales@ErgonomicPartners.com
www.ErgonomicPartners.com
Tel: (314) 884-8884

Page Intentionally Left Blank

Table of Contents

	Service Information	5
	Product Manual Safety Information	6
1	Introduction	7
2	Radio Controlled Safety	8
2.1	Critical Installation Considerations	9
2.2	General.....	9
2.3	Persons Authorized to Operate Radio Controlled Cranes.....	9
2.4	Safety Information and Recommended Training for Radio Controlled Equipment Operators....	10
2.5	Transmitter Unit.....	11
2.6	Pre-Operation Test.....	11
2.7	Batteries	11
3	General System Information	12
3.1	Transmitter	12
3.1.1	External Illustration	12
3.1.2	Internal Illustration	13
3.2	Receiver	14
3.2.1	External Illustration	14
3.2.2	Internal Illustration	15
4	Function Settings	16
4.1	Transmitter	16
4.1.1	Transmitter Firmware Version	16
4.1.2	Transmitter Channel Settings	16
4.1.3	Remote Pairing	18
4.1.4	I-Chip	19
4.1.5	Transmitter Start Function Settings	19
4.1.6	Transmitter Inactivity Timer Settings	20
4.1.7	Transmitter Output Power Settings.....	20
4.1.8	Infrared Programming.....	20
4.1.9	Pushbutton Function Settings.....	20
4.1.10	Display Frequency Band.....	22
4.1.11	Output Feedback Settings	23
4.1.12	Zero-G Sensor Settings	23
4.2	Receiver	23
4.2.1	Receiver Channel Settings	23
4.2.2	Output Relay Configurations.....	24
4.2.3	Dipswitch Settings	29
4.2.4	Jumper Settings.....	32
4.2.5	Fuse Ratings.....	33
4.2.6	Indicator Light and Buzzer Installation.....	33
4.2.7	Other Function Output Relays Settings	34
4.2.8	System Channels Table.....	35
5	Receiver Installation	36
5.1	Output Relay Contact Diagrams.....	36
5.1.1	Flex 6EX2 (dual speed model)	36
5.2	Pre-installation Precautions.....	36
5.3	Step-by-Step Installation	37
6	Operating Procedures	40
6.1	General Operation.....	40
6.2	A/B Pushbutton Select Operation.....	41
6.3	Pitch & Catch Operation.....	41

6.4	Changing Batteries	41
6.5	Battery Charging	42
6.6	System Status Light Indications	43
6.6.1	Transmitter Status Indications	43
6.6.2	Receiver Status Indications	44
6.6.3	Receiver Power Indications	44
6.6.4	Receiver COM Indications	44
7	General Specifications	45

SERVICE INFORMATION

Your New Radio Remote Control System

Thank you for your purchase of Magnetek's Flex EX2 Radio Remote Equipment Control. Magnetek has set a whole new standard in radio remote performance, dependability, and value with this unique new line of handheld transmitters.

If your product ever needs modification or service, please contact one of our representatives at the following locations:

World Headquarters:

Magnetek, Inc.
N49 W13650 Campbell Drive
Menomonee Falls, WI 53051

Distributed by Ergonomic Partners

Sales@ErgonomicPartners.com

www.ErgonomicPartners.com

Tel: (314) 884-8884

© 2017 MAGNETEK

All rights reserved. This notice applies to all copyrighted materials included with this product, including, but not limited to, this manual and software embodied within the product. This manual is intended for the sole use of the person(s) to whom it was provided, and any unauthorized distribution of the manual or dispersal of its contents is strictly forbidden. This manual may not be reproduced in whole or in part by any means whatsoever without the expressed written permission of MAGNETEK.

PRODUCT MANUAL SAFETY INFORMATION

Magnetek, Inc. (Magnetek) offers a broad range of radio remote control products, control products and adjustable frequency drives, and industrial braking systems for overhead material handling applications. This manual has been prepared by Magnetek to provide information and recommendations for the installation, use, operation and service of Magnetek's material handling products and systems (Magnetek Products). Anyone who uses, operates, maintains, services, installs or owns Magnetek Products should know, understand and follow the instructions and safety recommendations in this manual for Magnetek Products.

The recommendations in this manual do not take precedence over any of the following requirements relating to cranes, hoists and lifting devices:

- Instructions, manuals, and safety warnings of the manufacturers of the equipment where the radio system is used,
- Plant safety rules and procedures of the employers and the owners of facilities where the Magnetek Products are being used,
- Regulations issued by the Occupational Health and Safety Administration (OSHA),
- Applicable local, state or federal codes, ordinances, standards and requirements, or
- Safety standards and practices for the overhead material handling industry.

This manual does not include or address the specific instructions and safety warnings of these manufacturers or any of the other requirements listed above. It is the responsibility of the owners, users and operators of the Magnetek Products to know, understand and follow all of these requirements. It is the responsibility of the owner of the Magnetek Products to make its employees aware of all of the above listed requirements and to make certain that all operators are properly trained. **No one should use Magnetek Products prior to becoming familiar with and being trained in these requirements.**

WARRANTY INFORMATION

FOR INFORMATION ON MAGNETEK'S PRODUCT WARRANTIES BY PRODUCT TYPE, PLEASE VISIT WWW.MAGNETEK.COM.

1 Introduction

The **Flex EX2** radio remote control systems are designed for control of industrial equipment and machinery such as overhead traveling cranes, jib cranes, gantry cranes, tower cranes, electric hoists, winches, monorails, conveyor belts, mining equipment and other material handling equipment where wireless control is preferred.

Each **Flex EX2** system consists of a transmitter handset and receiver unit. Other standard-equipped accessories include transmitter waist belt, spare transmitter power key, vinyl pouch, “AA” alkaline batteries, pushbutton labels, output cable, and instruction manual CD.

List of notable features includes:

- **Advanced Controls** – the system utilizes dual advanced microprocessor controls with 32bit CRC and Hamming Code, providing ultra-fast, safe, precise, and error-free encoding and decoding.
- **Frequency Hopping RF Transceiver** – the system automatically searches and locks onto a free and uninterrupted channel at every system startup or during operation when encountering radio interference. The system is also capable of two-way communication between the transmitter and receiver as well as receiver-to-receiver with system status and relay output feedbacks.
- **Zero-G Sensor Embedded** – the transmitter is embedded with a Zero-G sensor to guard against any unintended control of the crane or equipment when transmitter is thrown or dropped.
- **Wireless Remote Pairing Function** – system information can be transferred wirelessly between two transmitters or between a transmitter and a receiver without the hassle of resetting the spares.
- **Reliable Pushbuttons** – the pushbuttons have gold-plated contacts and are rated for more than 2 million press cycles. The defined snap-action steps provide positive tactile feedback even through gloves.
- **Low Power Consumption** – requires only two “AA” alkaline batteries for more than 100 hours of uninterrupted operation between replacements.
- **Durable Nylon and Fiberglass Composite Enclosures** – highly resistant to breakage and deformation even in the most abusive environments. The receiver enclosures and output cables are UL94-V0 rated. The transmitter and receiver enclosures are IP66 rated.
- **Full Compliance** – all systems fully comply with the FCC Part: 15 Rules and European Safety Standards.
- **Other Optional Accessories and Features** – transmitter magnet mount, transmitter belt clip, transmitter lanyard, transmitter rubber guard, miniature indicator light and buzzer, charging station, tandem function, random access function, multiple receivers function, and many others.

2 Radio Controlled Safety

WARNINGS and CAUTIONS

Throughout this document WARNING and CAUTION statements have been deliberately placed to highlight items critical to the protection of personnel and equipment.



WARNING

WARNING indicates a potentially hazardous situation which, if not avoided, could result in death or serious injury.



CAUTION

CAUTION indicates a potentially hazardous situation which, if not avoided, could result in minor or moderate injury. It may also be used to alert against unsafe practices.

***NOTE:** A NOTE statement is used to notify people of installation, operation, programming, or maintenance information that is important, but not hazard-related.*

WARNINGS and CAUTIONS SHOULD NEVER BE DISREGARDED.

The safety rules in this section are not intended to replace any rules or regulations of any applicable local, state, or federal governing organizations. Always follow your local lockout and tagout procedure when maintaining any radio equipment. The following information is intended to be used in conjunction with other rules or regulations already in existence. It is important to read all of the safety information contained in this section before installing or operating the Radio Control System.

2.1 Critical Installation Considerations



Prior to installation and operation of this equipment, read and develop an understanding of the contents of this manual and the operation manual of the equipment or device to which this equipment will be interfaced. Failure to follow this warning could result in serious injury or death and damage to equipment.

All equipment must have a mainline contactor installed and all tracked cranes, hoists, lifting devices and similar equipment must have a brake installed. Failure to follow this warning could result in serious injury or death and damage to equipment.

An audible and/or visual warning means must be provided on all remote controlled equipment as required by code, regulation, or industry standard. These audible and/or visual warning devices must meet all governmental requirements. Failure to follow this warning could result in serious injury or death and damage to equipment.

Follow your local lockout tagout procedure before maintaining any remote controlled equipment. Always remove all electrical power from the crane, hoist, lifting device or similar equipment before attempting any installation procedures. De-energize and tagout all sources of electrical power before touch-testing any equipment. Failure to follow this warning could result in serious injury or death and damage to equipment.

The direct outputs of this product are not designed to interface directly to two state safety critical maintained functions, i.e., magnets, vacuum lifts, pumps, emergency equipment, etc. A mechanically locking intermediate relay system with separate power considerations must be provided. Failure to follow this warning could result in serious injury or death or damage to equipment.

2.2 General

Radio controlled material handling equipment operates in several directions. Cranes, hoists, lifting devices and other material handling equipment can be large and can operate at high speeds. The equipment is often operated in areas where people are working in close proximity to the material handling equipment. **The operator must exercise extreme caution at all times.** Workers must constantly be alert to avoid accidents. The following recommendations have been included to indicate how careful and thoughtful actions may prevent injuries, prevent damage to equipment, or even save a life.

2.3 Persons Authorized to Operate Radio Controlled Cranes

Only properly trained persons designated by management should be permitted to operate radio controlled equipment.

Radio controlled cranes, hoists, lifting devices and other material handling equipment should not be operated by any person who cannot read or understand signs, notices and operating instructions that pertain to the equipment.

Radio controlled equipment should not be operated by any person with insufficient eyesight or hearing or by any person who may be suffering from a disorder or illness that may cause them to lose control of the equipment, is taking any medication that may cause loss of equipment control, or is under the influence of alcohol or drugs.

2.4 Safety Information and Recommended Training for Radio Controlled Equipment Operators

Anyone being trained to operate radio controlled equipment should possess as a minimum the following knowledge and skills before using the radio controlled equipment.

The operator should:

- have knowledge of hazards pertaining to equipment operation
- have knowledge of safety rules for radio controlled equipment
- have the ability to judge distance of moving objects
- know how to properly test prior to operation
- be trained in the safe operation of the radio transmitter as it pertains to the crane, hoist, lifting device or other material handling equipment being operated
- have knowledge of the use of equipment warning lights and alarms
- have knowledge of the proper storage space for a radio control transmitter when not in use
- be trained in transferring a radio control transmitter to another person
- be trained how and when to report unsafe or unusual operating conditions
- test the transmitter emergency stop and all warning devices prior to operation; testing should be done on each shift, without a load
- be thoroughly trained and knowledgeable in proper and safe operation of the crane, hoist, lifting device, or other material handling equipment that utilizes the radio control
- know how to keep the operator and other people clear of lifted loads and to avoid “pinch” points
- continuously watch and monitor status of lifted loads
- know and follow cable and hook inspection procedures
- know and follow the local lockout and tagout procedures when servicing radio controlled equipment
- know and follow all applicable operating and maintenance manuals, safety procedures, regulatory requirements, and industry standards and codes

The operator shall not:

- lift or move more than the rated load
- operate the material handling equipment if the direction of travel or function engaged does not agree with what is indicated on the controller
- use the crane, hoist or lifting device to lift, support or transport people
- lift or carry any loads over people
- operate the crane, hoist or lifting device unless all persons, including the operator, are and remain clear of the supported load and any potential pinch points
- operate a crane, hoist or lifting device when the device is not centered over the load
- operate a crane, hoist or lifting device if the chain or wire rope is not seated properly in the sprockets, drum or sheave
- operate any damaged or malfunctioning crane, hoist, lifting device or other material handling equipment
- change any settings or controls without authorization and proper training
- remove or obscure any warning or safety labels or tags
- leave any load unattended while lifted
- leave power on the radio controlled equipment when the equipment is not in operation

- operate any material handling equipment using a damaged controller because the unit may be unsafe
- operate manual motions with other than manual power
- operate radio controlled equipment when low battery indicator is on



The operator should not attempt to repair any radio controller. If any product performance or safety concerns are observed, the equipment should immediately be taken out of service and be reported to the supervisor. Damaged and inoperable radio controller equipment should be returned to Magnetek for evaluation and repair. Failure to follow this warning could result in serious injury or death and damage to equipment.

2.5 Transmitter Unit

Transmitter switches should never be mechanically blocked on or off. When not in use, the operator should turn the transmitter off. A secure storage space should be provided for the transmitter unit, and the transmitter unit should always be placed there when not in use. This precaution will help prevent unauthorized people from operating the material handling equipment.

Spare transmitters should be stored in a secure storage space and only removed from the storage space after the current transmitter in use has been turned off, taken out of the service area and secured.

2.6 Pre-Operation Test

At the start of each work shift, or when a new operator takes control of the crane, operators should do, as a minimum, the following steps before making lifts with any crane or hoist:

Test all warning devices.

Test all direction and speed controls.

Test the transmitter emergency stop.

2.7 Batteries



Know and follow proper battery handling, charging and disposal procedures. Improper battery procedures can cause batteries to explode or do other serious damage. Failure to follow this warning could result in serious injury or death and damage to equipment.

3 General System Information

3.1 Transmitter

3.1.1 External Illustration

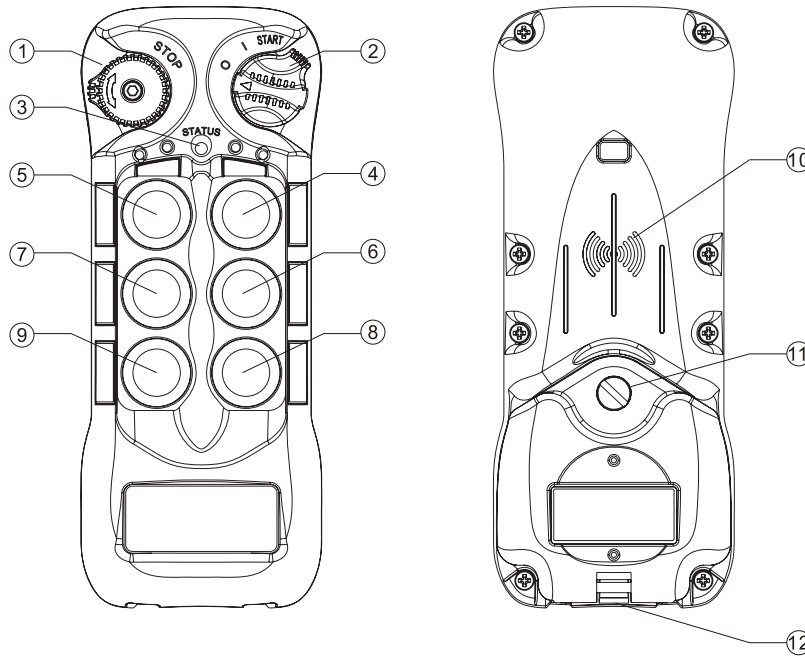

- | | | | |
|----|----------------------|-----|--|
| 1. | STOP Button | 7. | Pushbutton 4 (PB4) |
| 2. | Power Key Switch | 8. | Pushbutton 5 (PB5) |
| 3. | Status LED Indicator | 9. | Pushbutton 6 (PB6) |
| 4. | Pushbutton 1 (PB1) | 10. | Future Feature |
| 5. | Pushbutton 2 (PB2) | 11. | Battery Cover Screw |
| 6. | Pushbutton 3 (PB3) | 12. | Lanyard and Waist Belt Attachment Slot |

3.1.2 Internal Illustration

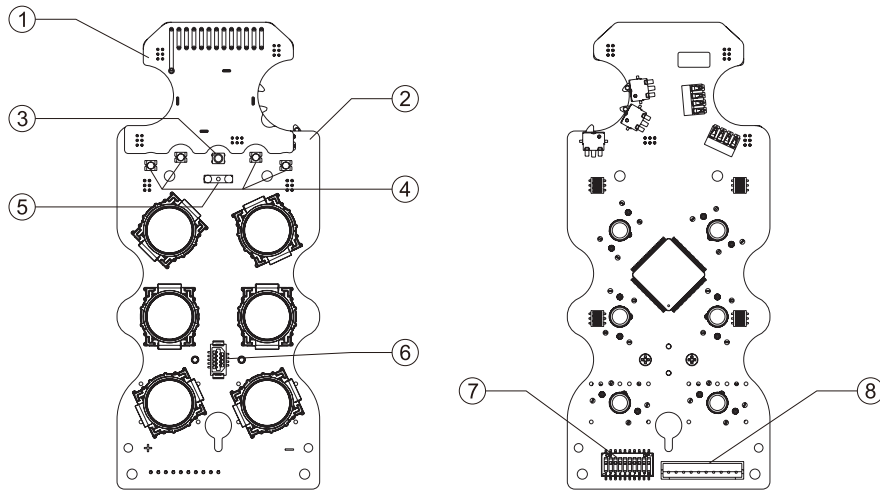

- | | | | |
|----|------------------------|----|--------------------|
| 1. | RF Transceiver Board | 5. | Infrared Sensors |
| 2. | Encoder Board | 6. | I-Chip Slot |
| 3. | Status LED Indicator | 7. | Function Dipswitch |
| 4. | A/B/C/D LED Indicators | 8. | Programming Port |

3.2 Receiver

3.2.1 External Illustration

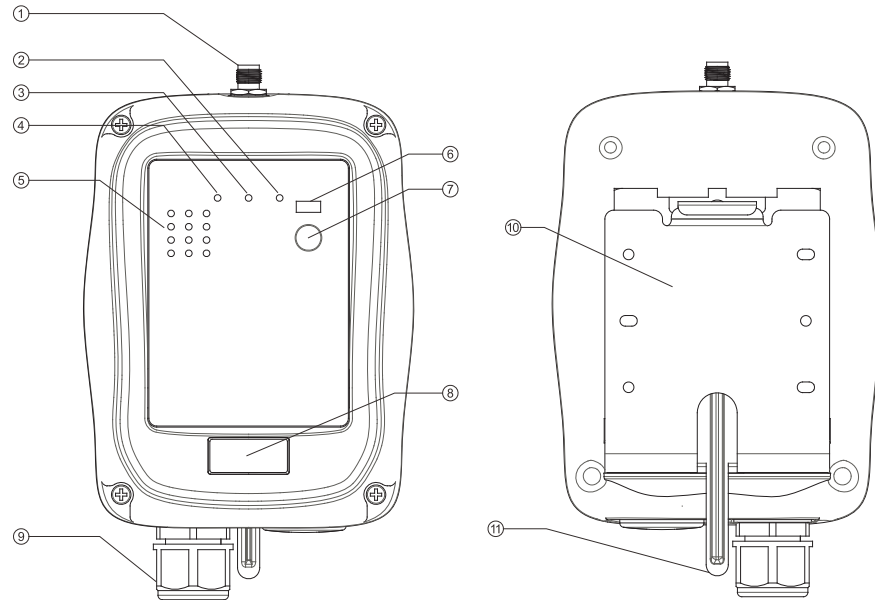

- | | | | |
|----|----------------------------------|-----|--------------------------|
| 1. | External Antenna Port (optional) | 7. | Remote Pairing Button |
| 2. | COM LED Indicator | 8. | System Information |
| 3. | Status LED Indicator | 9. | Cord Grip |
| 4. | Power LED Indicator | 10. | Mounting Bracket |
| 5. | Output Relay LED Indicators | 11. | Mounting Bracket Release |
| 6. | Infrared Sensors | | |

3.2.2 Internal Illustration

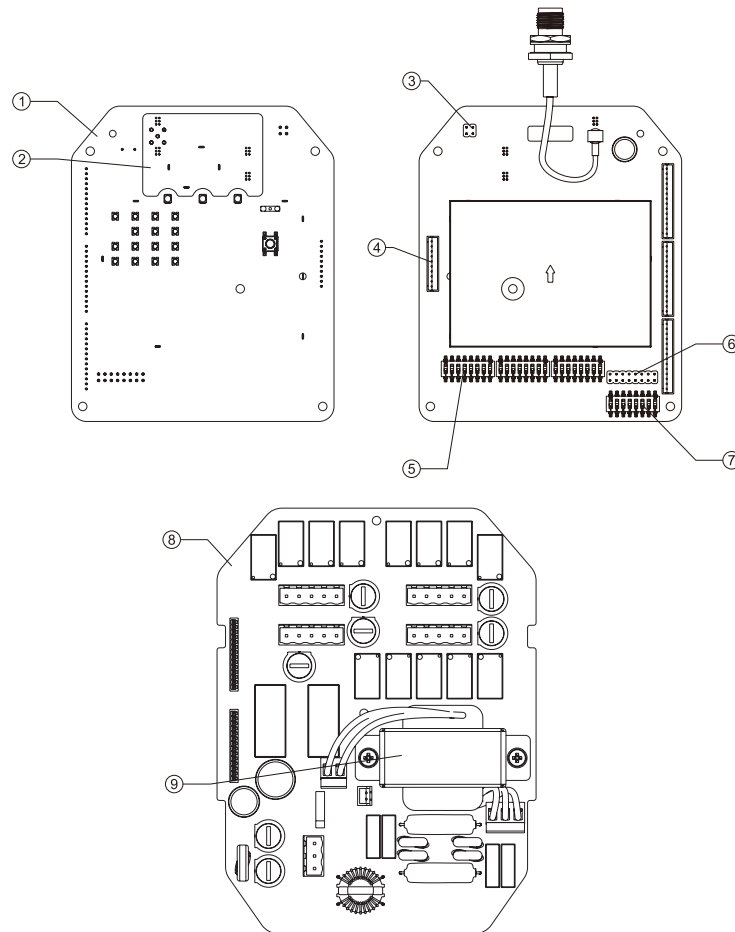

- | | | | |
|----|-------------------------|----|----------------------------|
| 1. | Decoder Board | 6. | Function Jumpers |
| 2. | RF Transceiver Board | 7. | Channel Dipswitch |
| 3. | INT/EXT Antenna Jumpers | 8. | AC Line Filter/Relay Board |
| 4. | Programming Port | 9. | Power Transformer |
| 5. | Function Dipswitches | | |

4 Function Settings

4.1 Transmitter

4.1.1 Transmitter Firmware Version

1. Rotate the power switch key to OFF (0) position.
2. With the STOP button elevated, press and hold PB1 and PB3 at the same time.
3. Rotate the power switch key to ON (1) position.
4. Release PB1 and PB3 at the same time. The Status LED displays firmware version with red, green and orange blinks.
5. Exit Firmware Version mode by rotating the power switch key to OFF (0) position.

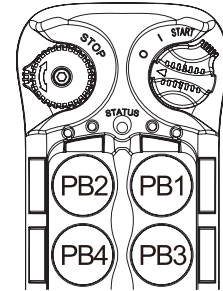

4.1.2 Transmitter Channel Settings

A. Unassigned Channel Scheme (no preset system channel)

When both transmitter and receiver are set to unassigned channel scheme (no preset channel), the system automatically searches and locks onto a free and uninterrupted channel at every transmitter startup.

NOTE: Pitch and catch configurations are unable to be set to the unassigned channel scheme.

1. Rotate the power switch key to OFF (0) position.
2. With the STOP button elevated, press and hold PB1 and PB2 at the same time.
3. Rotate the power switch key to ON (1) position.
4. Release PB1 and PB2 at the same time. The system will enter Channel Setting mode. The Status LED displays current channel setting with red and green blinks. A green blink represents the tens (+10) and a red blink represents the units (+1). For example, 1 green blink followed by 5 red blinks is channel 15. Channel unassigned is represented by solid orange on the Status LED.
5. Change transmitter channel to "channel unassigned" by pressing PB4 one time (Status LED displays solid orange).
6. Transfer "channel unassigned" setting to the receiver by rotating and holding the power switch key at START position until the Status LED turns to solid green (transfer complete). Turn off the transmitter power if solid green is not shown on the Status LED after more than 10 seconds (transfer incomplete); the transmitter will revert back to its previous channel setting. Make sure the receiver power is turned on and the receiver is within the operating distance during the entire process. When transmitter is set to "channel unassigned" the receiver must also set to "channel unassigned" in order for the entire system to work.
7. Exit Channel Setting mode by rotating the power switch key to OFF (0) position.

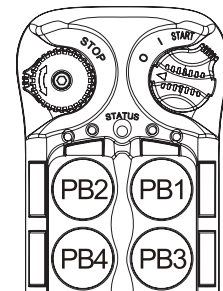

B. Assigned Channel Scheme (preset system channel)

Both transmitter and receiver are assigned with a matching preset channel (channel 01 - 62).

NOTE: Pitch and catch configurations **MUST** be set to the assigned channel scheme.

1. Rotate the power switch key to OFF (0) position.
2. With the STOP button elevated, press and hold PB1 and PB2 at the same time.
3. Rotate the power switch key to ON (1) position.
4. Release PB1 and PB2 at the same time. The system will enter Channel Setting mode. The Status LED displays current channel setting with red and green blinks. A green blink represents the tens (+10) and a red blink represents the units (+1). For example, 1 green blink followed by 5 red blinks is channel 15. Channel unassigned is represented by solid orange on the Status LED.
5. Change transmitter channel by pressing PB1 to increment the units (+1) and PB2 to increment the tens (+10). For example, press PB2 two times and then PB1 four times for channel 24 (Status LED blinks 2 greens and 4 reds).
6. Transfer the newly selected channel to the receiver by rotating and holding the power switch key at START position until the Status LED turns to solid green (transfer complete). Turn off the transmitter power if solid green is not shown on the Status LED after more than 10 seconds (transfer incomplete); the transmitter will revert back to its previous channel setting. Make sure the receiver power is turned on and the receiver is within the operating distance during the entire process. **Skip step 6 if changing receiver channel is not required.**
7. Exit Channel Setting mode by rotating the power switch key to OFF (0) position.

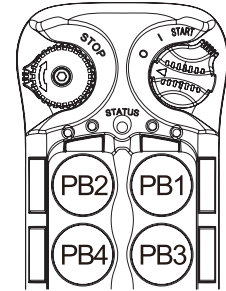

NOTE: When selecting a new channel, make sure each button press does not exceed 3 seconds.

Important Note:

Step 6 is strictly required if you are intending to change the entire system channel (both transmitter and receiver). The entire system no longer works if step 6 is skipped because the transmitter and receiver channels are now different (new vs. old). In this case you would have to redo steps 1-4 and step 6 to transfer the newly selected transmitter channel to the receiver.

4.1.3 Remote Pairing

A. Transmitter-to-Transmitter Pairing:

1. Rotate the power switch key to OFF (0) position.
2. With the STOP button elevated, press and hold PB1 and PB3 at the same time.
3. Rotate the power switch key to ON (I) position.
4. Release PB1 and PB3 at the same time. The system will enter Remote Pairing mode. The Status LED displays firmware version with red, green and orange blinks.
5. Output data (original transmitter) by pressing and holding PB2 (Status LED off).
6. Receive data (new transmitter) by pressing and holding PB1 (Status LED blinks green).
7. When the Status LED (receiving data end) turns to solid green while both pushbuttons are still pressed down, the pairing is completed.
8. Exit Remote Pairing mode by rotating the power switch key to OFF (0) position.

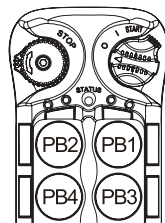
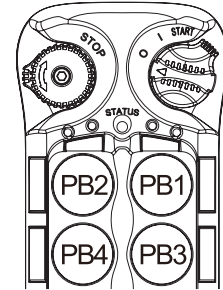

Output data – original transmitter
(press and hold PB2)

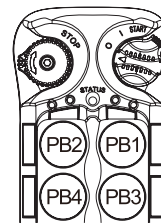

Receive data – new transmitter
(press and hold PB1)

NOTE: During remote pairing make sure the distance between the two transmitters is no more than 1 meter.

B. Receiver-to-Transmitter Pairing:

JP8 Open Method: After the transmitter enters the Remote Pairing mode, output receiver data by pressing and holding the PAIRING button located on the receiver cover and receive data by pressing and holding PB3 on the transmitter, both at the same time. When the transmitter Status LED turns to solid green while both pushbuttons are still pressed down, the pairing is completed.

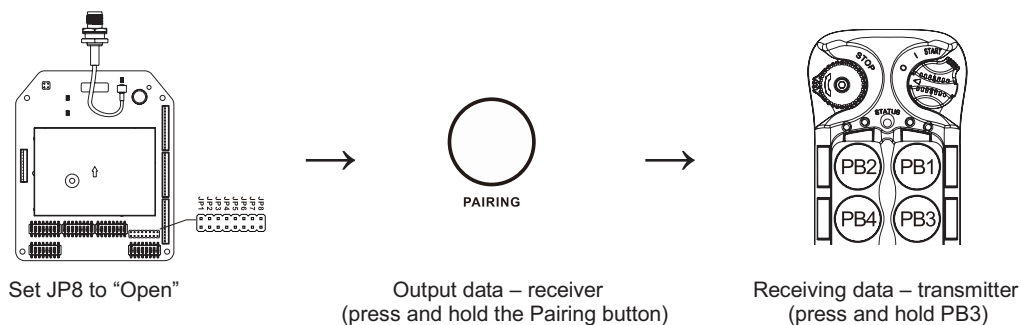

JP8 Short Method (press Pairing button not required): After the transmitter enters the Remote Pairing mode, press and hold PB3 on the transmitter until the Status LED turns to solid green, indicating the pairing is complete. Make sure the transmitter and receiver are within 10 meters from one another and that no other active receivers are nearby during the pairing process. During pairing process the receiver MAIN relays must be deactivated (relay open).

4.1.4 I-Chip

When an I-Chip is inserted into the Flex EX2 transmitter it becomes backwards compatible with a Flex EX (GEN 1) receiver. Refer to the appropriate Flex EX (GEN 1) manual for information on configuring the I-Chip.

NOTE: A Flex EX (GEN 1) transmitter will NOT work with a Flex EX2 receiver.

4.1.5 Transmitter Start Function Settings

When transmitter goes into sleep mode the system is temporarily deactivated (MAIN relays opened). Execute the START command or press any pushbutton to wake up the system (MAIN relays closed).

	Dipswitch Settings	Function
1	xxxxxxxx0	START Reactivation
2	xxxxxxxx1	Any Button Reactivation

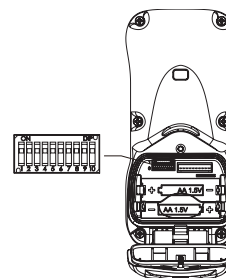

4.1.6 Transmitter Inactivity Timer Settings

Set how long the system waits to enter the sleep mode when the transmitter is not in use (pushbutton not pressed). When transmitter goes into sleep mode the receiver MAIN relays are deactivated.

	Dipswitch Settings	Time		Dipswitch Settings	Time
1	xxx000xxxx	1 minute	5	xxx100xxxx	10 minutes
2	xxx001xxxx	20 seconds	6	xxx101xxxx	30 minutes
3	xxx010xxxx	3 minutes	7	xxx110xxxx	60 minutes
4	xxx011xxxx	5 minutes	8	xxx111xxxx	Constant On (sleep mode disabled)

4.1.7 Transmitter Output Power Settings

1mW offers the shortest operating range with lowest battery consumption while 10mW offers the longest operating range with highest battery consumption (manufacturer preset at 1mW).

	Dipswitch Settings	Output Power		Dipswitch Settings	Output Power
1	000xxxxxxx	1mW	5	100xxxxxxx	5mW
2	001xxxxxxx	2mW	6	101xxxxxxx	6mW
3	010xxxxxxx	3mW	7	110xxxxxxx	8mW
4	011xxxxxxx	4mW	8	111xxxxxxx	10mW

4.1.8 Infrared Programming

Other custom functions and settings not listed in this manual can be programmed via the infrared IR programmer unit, such as the system serial number, frequency range, relay output status feedback, new and updated functions, and many others. Please contact Magnetek field service for more details.

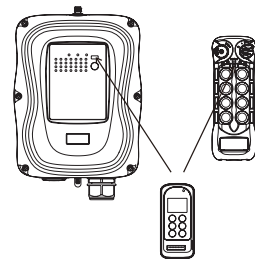

4.1.9 Pushbutton Function Settings

1. Rotate the power switch key to OFF (0) position.
2. With the STOP button elevated, press and hold PB3 and PB4 at the same time.
3. Rotate the power switch key to ON (I) position.
4. Release PB3 and PB4 at the same time. The system will enter Pushbutton Function mode.

5. The Status LED displays current pushbutton function setting with orange, green and red blinks. An orange blink represents the hundreds (+100), a green blink represents the tens (+010) and a red blink represents the units (+001). For example, **1** orange blink followed by **2** green blinks and **5** red blinks is pushbutton function no. **125**. Pushbutton function number with "0" is represented by no orange, green or red blink. For example, **1** orange blink followed by **5** red blinks is pushbutton function no. **105**.
6. Set pushbutton function number by pressing PB3 to increment the hundreds (+100), PB2 to increment the tens (+010), PB1 to increment the units (+001), and PB4 to reset (000 - solid orange). For example, press PB3 one time, PB2 four times, and PB1 six times for pushbutton function no. **146** (Status LED blinks **1** orange, **4** greens and **6** reds).
7. Exit Pushbutton Function mode by rotating the power switch key to OFF (0) position.

4.1.9.1 Toggled Pushbutton with LED Indication

Set pushbutton toggled function (latching output relay) with LED indications. LED 1 - 4 shown inside the shaded box illustrates which LED on the transmitter lights up when the designated pushbutton is pressed.

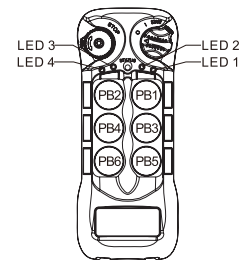

Function Number	Display Type	PB1	PB2	PB3	PB4	PB5	PB6
1	1 Red	Normal	Normal	Normal	LED 4	Normal	Normal
2	2 Reds	Normal	Normal	LED 3	LED 4	Normal	Normal
3	3 Reds	Normal	LED 2	LED 3	LED 4	Normal	Normal
4	4 Reds	LED 1	LED 2	LED 3	LED 4	Normal	Normal
7	7 Reds	Normal	Normal	Normal	Normal	Normal	LED 2
8	8 Reds	Normal	Normal	Normal	Normal	LED 1	LED 2

* PB1...PB6 → Pushbutton number.

* Normal → Normal momentary contact.

* LED 1 - LED 4 → Pushbutton toggled function with designated LED indication.

4.1.9.2 A/B Pushbutton Select with LED Indication

There are 4 different types of A/B selector sequence available. Choose one that is most suitable for your application. See **Section 5.1 on page 36** for output relay contact diagrams.

Type-A selector sequence: A → B

Type-B selector sequence: Off → A → B

Type-C selector sequence: A → B → A+B

Type-D selector sequence: Off → A → B → A+B

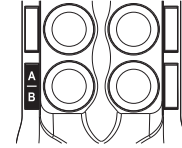

Function Number	Display Type	PB1	PB2	PB3	PB4	PB5	PB6
115	1 Orange + 1 Green + 5 Reds	Normal	Normal	Normal	Normal	Normal	A/1&2
116	1 Orange + 1 Green + 6 Reds	Normal	Normal	Normal	Normal	Normal	B/1&2
117	1 Orange + 1 Green + 7 Reds	Normal	Normal	Normal	Normal	Normal	C/1&2
118	1 Orange + 1 Green + 8 Reds	Normal	Normal	Normal	Normal	Normal	D/1&2

* PB1...PB6 → Pushbutton number.

* Normal → Normal momentary contact.

* A/1&2 - D/1&2 → A/B pushbutton select function with designated LED indication.

4.1.10 Display Frequency Band

1. Rotate the power switch key to OFF (0) position.
2. With the STOP button elevated, press and hold PB2 and PB4 at the same time.
3. Rotate the power switch key to ON (I) position.
4. Release PB2 and PB4 at the same time. The system will enter Frequency Band Display mode.
5. The Status LED displays the preset transmitter frequency band with orange, green and red blinks. An orange blink represents the hundreds (+100), a green blink represents the tens (+010) and a red blink represents the units (+001). For example, 4 orange blinks followed by 3 green blinks and 3 red blinks is 433 MHz.
6. Exit Frequency Band Display mode by rotating the power switch key to OFF (0) position.

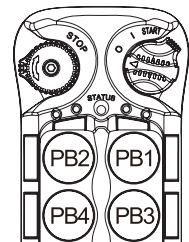

4.1.11 Output Feedback Settings

Up to 4 assignable relay outputs can be programmed into the system and feedback to the transmitter LED indicators during operation. These settings require using the infrared IR programmer unit. Please contact Magnetek field service for more details.

4.1.12 Zero-G Sensor Settings

The transmitter is embedded with a Zero-G sensor to guard against any unintended control of the crane or equipment when transmitter is thrown or dropped. When triggered, the receiver MAIN relays are deactivated with the exception of the horn output that can be assigned to the K25 Function output relay. This horn output setting requires the infrared IR programmer unit. Please contact Magnetek field service for more details.

	Dipswitch Settings	Function
1	xxxxxxx0x	Sensor Disabled
2	xxxxxxx1x	Sensor Enabled

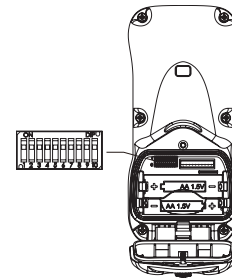

4.2 Receiver

4.2.1 Receiver Channel Settings

Set the receiver channel by configuring the channel dipswitch located on the decoder board. Only the first 6 dip positions are used for channel programming. The system channels table in **Section 4.2.8 on page 35** illustrates which dipswitch setting corresponds to which channel. Once the receiver channel is altered, make sure to change the transmitter channel as well. The channel on both transmitter and receiver must be identical in order for the system to work (*see Section 4.1.2 on page 16, part B*). When set to all zeros (000000), the receiver becomes unassigned channel scheme (*see Section 4.1.2 on page 16, part A*).

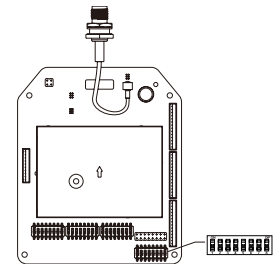

Example:

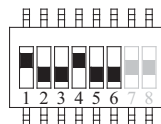

Top position → “1”
Bottom position → “0”

The above dipswitch setting “1 0 0 1 0 0” corresponds to “channel 36” in the system channels table in **Section 4.2.8 on page 35**.

4.2.2 Output Relay Configurations

4.2.2.1 Output Relay Types

1. **2 output relays per motion – single speed only**

Output relays with Forward (F) and Reverse (R) 1st speed only.

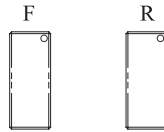

2. **3 output relays per motion – shared 2nd speed output relay**

Output relays with Forward 1st speed (F1), Reverse 1st speed (R1) and Forward/Reverse 2nd speed (F/R2). Forward and Reverse 2nd speed (F/R2) share the same output relay.

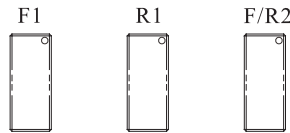

3. **4 output relays per motion – separate 1st and 2nd speed output relays**

Output relays with Forward 1st speed (F1), Reverse 1st speed (R1), Forward 2nd speed (F2) and Reverse 2nd speed (R2). Forward and Reverse 2nd speed are separate output relays.

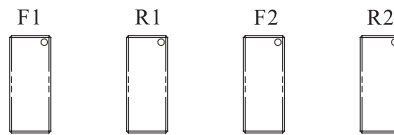

4.2.2.2 Output Relay Actions at 2nd Speed (Flex 6EX only)

1. **3 output relays configuration with Closed/Closed contact at 2nd speed**

F1 (or R1) output relay closed at 1st speed and F1 + F/R2 (or R1 + F/R2) output relays closed at 2nd speed. **See Section 4.2.3.1 on page 29** on how to set to this function.

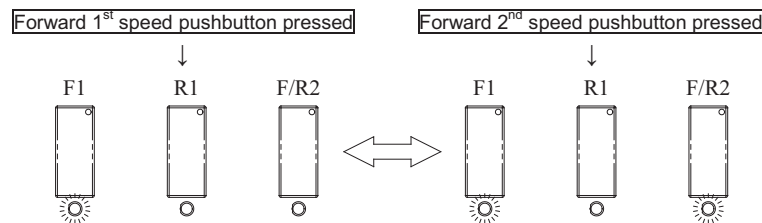

- 2. 4 output relays configuration with Opened/Closed contact at 2nd speed**
 F1 (or R1) output relay closed at 1st speed and F2 (or R2) output relay closed at 2nd speed. **See Section 4.2.3.1 on page 29** on how to set to this function.

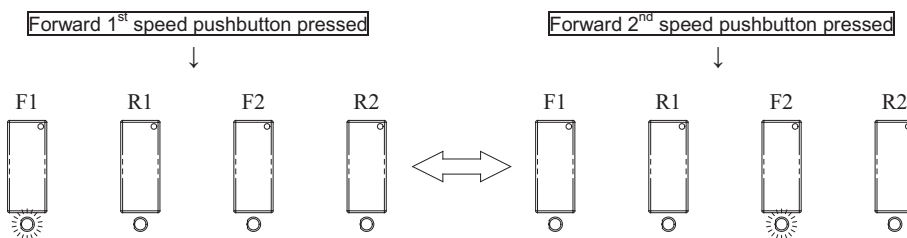

- 3. 4 output relays configuration with Closed/Closed contact at 2nd speed**
 F1 (or R1) output relay closed at 1st speed and F1 + F2 (or R1 + R2) output relays closed at 2nd speed. **See Section 4.2.3.1 on page 29** on how to set to this function.

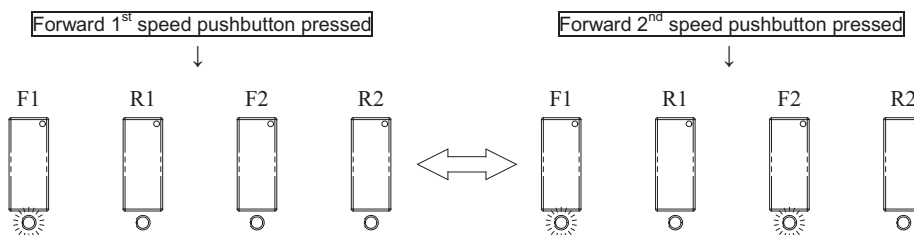

- 4. 4 output relays configuration with Slow and Fast output relays (Type A)**
 Fwd (or Rev) + Slow output relays closed at 1st speed and Fwd (or Rev) + Fast output relays closed at 2nd speed. **See Section 4.2.3.1 on page 29** on how to set to this function.

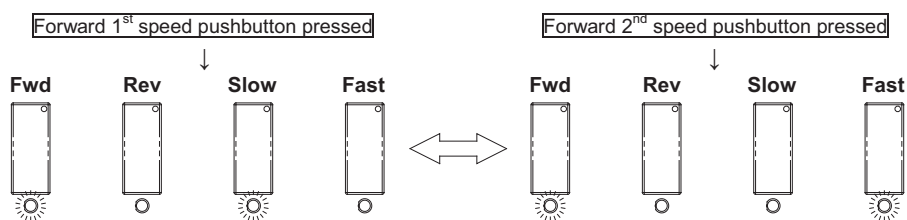

5. **4 output relays configuration with Slow and Fast output relays (Type B)**
 Fwd + Slow (or Rev + Slow) output relays closed at 1st speed and Fwd + Slow + Fast (or Rev + Slow + Fast) output relays closed at 2nd speed. **See Section 4.2.3.1 on page 29** on how to set to this function.

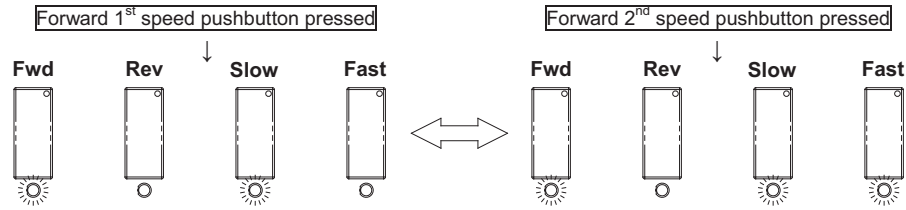

4.2.2.3 START + AUX Function

After executing the START command at transmitter startup the same START position becomes an auxiliary function with momentary contact connected through the K25 Function output relay (manufacturer preset). There are other types of auxiliary functions made available for the K25 Function output relays (**see Section 4.2.7 on page 34**). Contact Magnetek field service if your application requires other types of auxiliary functions.

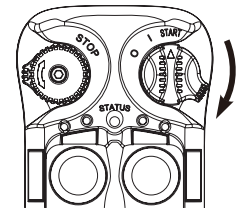

4.2.2.4 ON/OFF Pushbutton Function

The user can set any of the two adjacent pushbuttons on the transmitter to behave like a mechanical ON and OFF rocker or toggle switch. The ON output relay closes when the ON pushbutton is pressed (the OFF output relay opens) and the OFF output relay closes when the OFF pushbutton is pressed (the ON output relay opens). **See Section 4.2.3.1 on page 29** on how to set to this function.

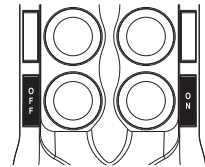

4.2.2.5 Brake Function

When the transmitter pushbutton is released from 2nd speed up to 1st speed, both 1st and 2nd speed output relays will open for up to 1 second and then with 1st speed output relay closed thereafter. **See Section 4.2.3.1 on page 29** on how to set to this function.

4.2.2.6 External Warning Function

The user can install an external warning device (rotating lights, horn, etc.) to the K25 Function output relay. The user can choose which pushbutton pair (or pairs) triggers the external warning device when pressed. **See Section 4.2.3.1 on page 29** on how to set to this function. The manufacturer preset START + AUX function in **Section 4.2.2.3 on page 26** must be disabled when set to this function. Please contact the ARC representative on how to disable the START + AUX function.

4.2.2.7 Momentary Contact

When the pushbutton is released the corresponding output relay will open or deactivate. This type of relay action usually applies to external applications such as the horn and buzzer. **See Section 4.2.3.2 on page 31** on how to set to this function.

4.2.2.8 Toggled Contact

When the pushbutton is released the corresponding output relay will maintain contact or closure until the user presses the same pushbutton again. This type of relay action usually applies to external applications such as lights. **See Section 4.2.3.2 on page 31** on how to set to this function.

4.2.2.9 Pitch & Catch Function

This function allows two operators controlling from opposite ends of a crane or equipment. When set to "Pitch & Catch" make sure the 2nd transmitter is set to the next highest channel (channel X+1). For example, if the system is set to channel 01 then the newly added 2nd transmitter must be set to channel 02 with identical serial number. Furthermore, the Channel dipswitch position #7 and #8 on the decoder board must set to "10" for 2-channel scanning (scans channel 01 and 02). **See Section 4.2.2.9 on page 27** and **Section 4.2.3.2 on page 31** on how to set to this function. Pitch & Catch function must set to assigned channel scheme (**see Section 4.1.2 on page 16**, part B).

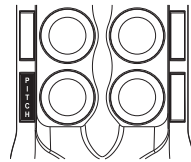
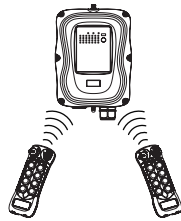

4.2.2.10 Receiver Channel Scanning Function

Receiver channel scanning function is applicable only when a preset channel is assigned to the system (see **Section 4.1.2 on page 16**, part B).

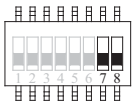
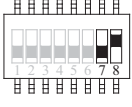
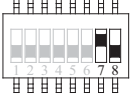
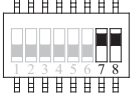
- (1)  → “00” manufacturer preset (channel X)*
- (2)  → “01” scans 2 channels (channel X and channel X+1)
- (3)  → “10” scans 3 channels (channel X... channel X+2)
- (4)  → “11” scans 4 channels (channel X... channel X+3)**

* Channel X → channel set on the Channel dipswitch.

** Contact Magnetek field service if your application requires scanning more than 4 channels.

Example: If the first 6 dipswitch positions are set to channel 01 (000001), when set to 2-channel scanning (type 2 above) the receiver will scan only channel 01 and 02.

4.2.3 Dipswitch Settings

4.2.3.1 Interlocked Pushbutton Pair

Interlocked means any pushbutton pair cannot be pressed simultaneously as each press will cancel the other out. Interlocked setting usually applies to electric motor's forward and reverse motion and ON and OFF switches. Each dipswitch on the decoder board corresponds to a pushbutton pair.

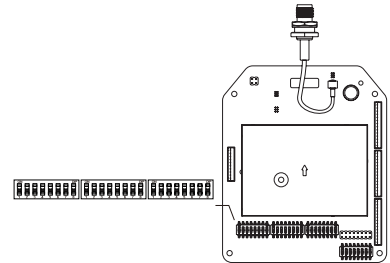

Dip Settings	Function Descriptions	# of Relays Used
00000000	Single speed only	2
00000010	4 output relays Closed/Closed relay action at 2nd speed (separate 2nd speed output relays)	4
00000100	3 output relays Closed/Closed relay action at 2nd speed (shared 2nd speed output relay)	3
00000110	4 output relays Opened/Closed relay action at 2nd speed (separate 2nd speed output relays)	4
00001000	Forward (or Reverse) + Fast output relays engaged at 2nd speed	4
00001010	Forward (or Reverse) + Slow + Fast output relays engaged at 2nd speed	4
00001100	On (right button) & Off (left button)	2
00010010	On + Start/Off + Start - For added safety, you must first rotate and hold the power switch key at START position and then press the ON or OFF pushbutton to activate the output relay.	2
00010100	FWD/REV toggled (latching)	2
00100000	Single speed + External warning*	2
00100010	4 output relays Closed/Closed relay action + External warning*	4
00100100	3 output relays Closed/Closed relay action + External warning*	3
00100110	4 output relays Opened/Closed relay action + External warning*	4
01000010	4 output relays Closed/Closed relay action + Brake	4
01000100	3 output relays Closed/Closed relay action + Brake	3
01000110	4 output relays Opened/Closed relay action + Brake	4

Dip Settings	Function Descriptions	# of Relays Used
01100010	4 output relays Closed/Closed relay action + Brake + External warning*	4
01100100	3 output relays Closed/Closed relay action + Brake + External warning*	3
01100110	4 output relays Opened/Closed relay action + Brake + External warning*	4

* External warning function requires installing an external warning device such as horn or lights to the K25 Function output relay. See Section 4.2.2.7 on page 26.

4.2.3.2 Non-Interlocked Pushbutton Pair

Non-interlocked setting allows the pushbutton pair to be pressed simultaneously. It usually applies to equipment's auxiliary functions such as lights, horn or buzzer. Each dipswitch on the decoder board corresponds to a pushbutton pair. Only the first 7 dipswitch positions are used (counting from left to right). The 8th dipswitch position (far right) is not used.



Function Code	Dip Position #1	Dip Position #2 - #4 (left button) and #5 - #7 (right button)	Function Description
A	1	000	Normal momentary contact
B	1	001	Toggled/latching contact (type A)
C	1	011	Toggled/latching contact (type B) <i>Output relay disconnects when STOP button is pressed or transmitter power is off</i>
D	1	100	Normal + Start function <i>For added safety, first rotate and hold the power switch key at the START position and then press the intended pushbutton to activate the output relay</i>
E	1	110	Pitch & Catch (type A)
F	1	101	Pitch & Catch (type B) <i>Receiver MAIN relays maintain closure during switchovers</i>
G	1	111	2 steps with Closed/Closed relay action

Example #1: Left button (set to function code A) / right button (set to function code B) → **1 000 001**

Example #2: Left button (set to function code C) / right button (set to function code D) → **1 011 100**

4.2.4 Jumper Settings

Jumper setting applies to functions such as the standard or reversed logic A/B selector sequence, firmware version, system testing and remote pairing methods.

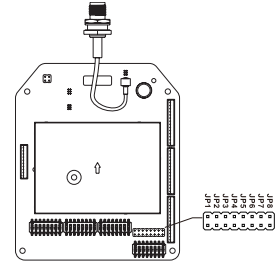

Jumper Settings	Function
JP3 (Opened)	Standard A/B selector sequence – Output relay A activated at A position, output relay B activated at B position, both relays activated at A+B position
JP3 (Inserted)	Reversed logic A/B selector sequence – Output relay B activated at A position, output relay A activated at B position, both relays deactivated at A+B position
JP6 (Inserted)	Display system firmware version
JP7 (Inserted)	For system testing only (receiver MAIN relays disabled)
JP8 (Opened)	Receiver-to-transmitter remote pairing (pressing the Pairing button required)
JP8 (Inserted)	Receiver-to-transmitter remote pairing (pressing the Pairing button not required)

4.2.5 Fuse Ratings

FUSE #	110 - 120VAC	220 - 240VAC	380 - 400VAC	410 - 460VAC	24VAC	42 & 48VAC	9 - 36VDC
F3 - F10	5.0A	5.0A	5.0A	5.0A	5.0A	5.0A	5.0A
F1 - F2	0.5A	0.5A	0.5A	0.5A	1.0A	1.0A	3.0A

4.2.6 Indicator Light and Buzzer Installation

The miniature indicator light and buzzer can be easily fitted onto the receiver enclosure. The indicator light or the buzzer works simultaneously with the receiver MAIN relays (manufacturer preset). When receiver MAIN relays are activated the indicator light or the buzzer is also activated, or vice versa. Make sure the indicator light or the buzzer is connected to the K30 Function output relay CN11 port located on the AC line filter/relay board inside the receiver. Contact Magnetek field service if you would like the indicator light or the buzzer to work differently.

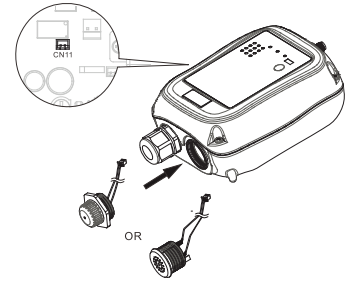

4.2.7 Other Function Output Relays Settings

Listed below are other types of functions that can be outputted through K25 and K30 Function outputs via the infrared IR programmer unit. Contact Magnetek field service for more details.

LV → Function relay closes when receiver voltage is low.

ID → Function relay works simultaneously with all motion commands.

NORMAL → START function + AUX with normal momentary output.

TOGGLE → START function + AUX with toggled/latching output.

TOG&E → START function + AUX with toggled/latching output. The relay opens when STOP button is pressed down and transmitter power is off.

S/P → Function relay closes when START command is executed and opens only when transmitter power is turned off.

EXT → Function relay works simultaneously with the receiver MAIN relays.

TDM A+B → Function relay closes when selector switch is rotated to the A+B position and opens when rotate to A or B positions (tandem monitoring output).

HORN → Function relay closes for up to 3 seconds when START command is executed at transmitter power on and then becomes a normal momentary output thereafter.

G SENSOR → Function relay closes when Zero-G sensor is triggered (receiver MAIN relays deactivated) and opens when receiver MAIN relays are reactivated.

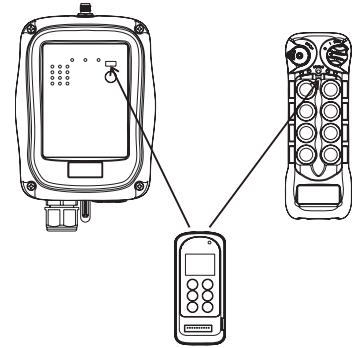

4.2.8 System Channels Table

The following dipswitch settings only apply to setting the channel in the receiver when using the assigned channel scheme (*see Section 4.2.1 on page 23*). For information on setting the transmitter channel when assigned channel is used, *see Section 4.1.2 on page 16*, part B.

Channel	Dipswitch Setting	Channel	Dipswitch Setting
01	000001	32	100000
02	000010	33	100001
03	000011	34	100010
04	000100	35	100011
05	000101	36	100100
06	000110	37	100101
07	000111	38	100110
08	001000	39	100111
09	001001	40	101000
10	001010	41	101001
11	001011	42	101010
12	001100	43	101011
13	001101	44	101100
14	001110	45	101101
15	001111	46	101110
16	010000	47	101111
17	010001	48	110000
18	010010	49	110001
19	010011	50	110010
20	010100	51	110011
21	010101	52	110100
22	010110	53	110101
23	010111	54	110110
24	011000	55	110111
25	011001	56	111000
26	011010	57	111001
27	011011	58	111010
28	011100	59	111011
29	011101	60	111100
30	011110	61	111101
31	011111	62	111110

NOTE: Channel unassigned is represented by “000000” dipswitch setting. *See Section 4.1.2 on page 16*, part A, unassigned channel scheme.

5 Receiver Installation

5.1 Output Relay Contact Diagrams

5.1.1 Flex 6EX2 (dual speed model)

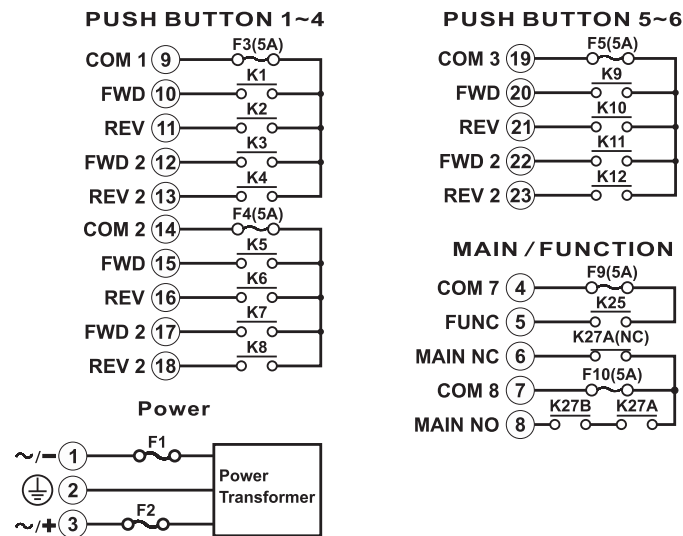

- For 9 - 36VDC power supply, wire #1 corresponds to the negative charge (-), wire #3 corresponds to the positive charge (+), and wire #2 is for GROUND.
- If PB5 (or PB6) is set to A/B pushbutton select function, connect output A to K9 (or K10) and output B to K11 (or K12). See Section 4.1.9 on page 20 on how to set to this function.
- Due to the possibility of voltage spikes on the contactors, suppressors are required on contactors being driven by Flex relays.

5.2 Pre-installation Precautions

1. Make sure the transmitter and receiver have the same serial numbers and are set to the same channel.
2. Make sure the receiver is not set to the same channel as any other systems in use in the surrounding area.
3. Make sure the crane or equipment is working properly prior to installation.
4. Make sure the power source to the receiver is set correctly.
5. Switch off the main power source to the crane or equipment prior to installation.

5.3 Step-by-Step Installation

Mounting Bracket Type 1

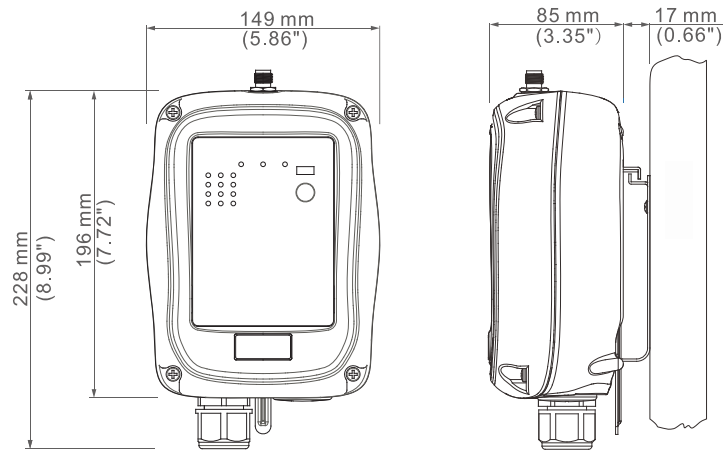

Mounting Bracket Type 2

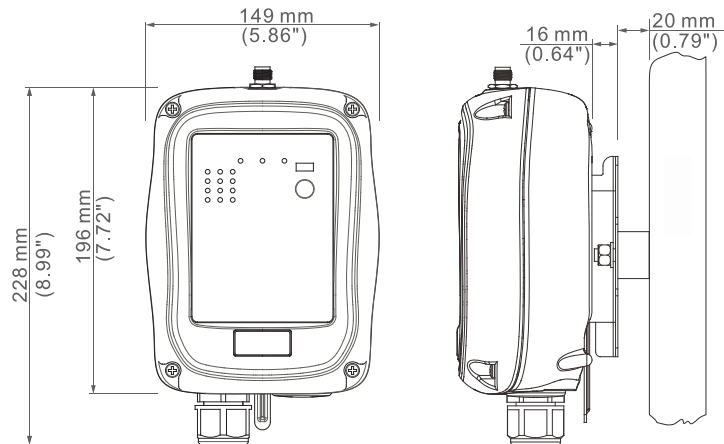

1. For best reception the location of the receiver should be visible to the operator at all times.
2. The location selected should not be exposed to high levels of electric noise. Mounting the receiver next to an unshielded variable frequency drive may cause radio interference. Always locate the receiver as far away from variable frequency drive and electric motor as possible.
3. Ensure the selected location has adequate space to accommodate the receiver. If an external antenna is used, to avoid the possibility of antenna damage always locate the receiver where the antenna is free from any obstructions.

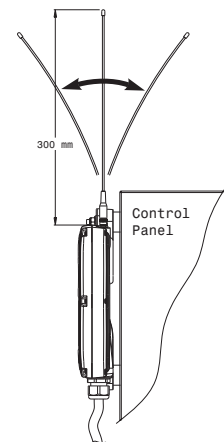

- When installing an external antenna make sure the MCX jack located on the decoder board inside the receiver is connected and jumper set to "EXT" position.



- For better reception, make sure the receiver is in an upright position.
- Drill four holes for mounting bracket type 1 and two holes for mounting bracket type 2 on the control panel, wall or location where the receiver is to be installed.
- Make sure the screws, bolts or shock absorbers (not provided with the system) are tightened after installation.
- Install suppressor on all contactors being driven by Flex relays. This is due to the possibility of voltage spike on the contractors.

Mounting Bracket Type 1

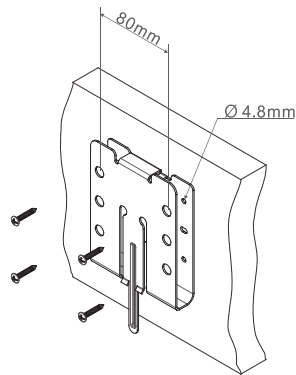

Mounting Bracket Type 2

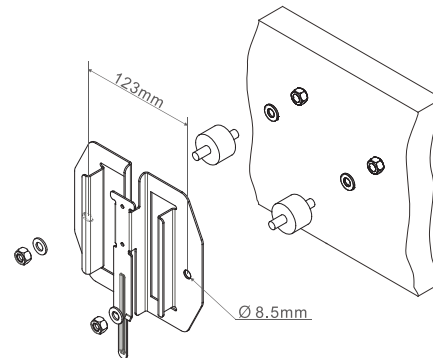

- Slide down the receiver along the guided track to secure the receiver to the mounting bracket.
- Remove the receiver by pressing down the bracket release and pulling the receiver upward until it clears the guided track.

Install

Mounting Bracket Type 1

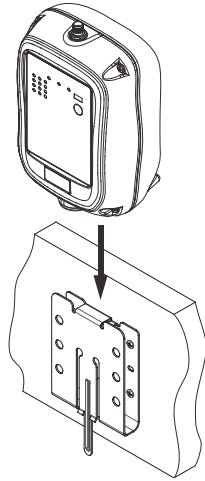

Mounting Bracket Type 2

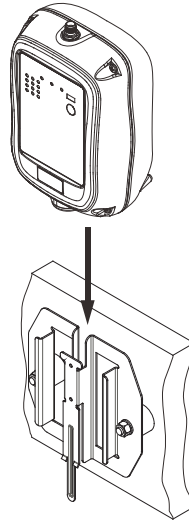

Remove

Mounting Bracket Type 1

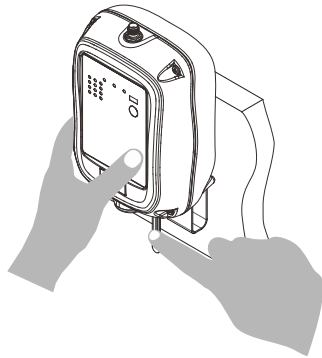

Mounting Bracket Type 2

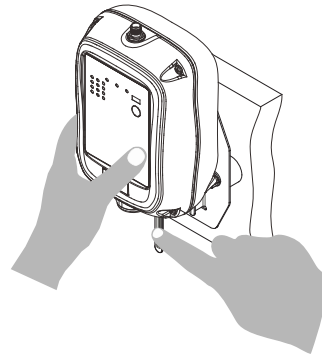

6 Operating Procedures

6.1 General Operation

1. Reset the STOP button located on the top left hand corner of the transmitter by rotating it clockwise or counterclockwise; the button will pop up. Turn on the transmitter power by inserting the power switch key and rotating to ON (I) position.

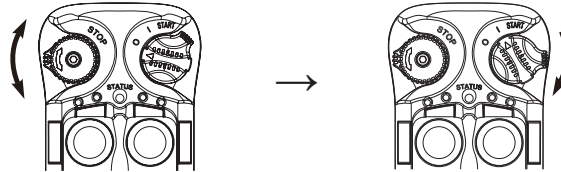

2. After turning on the transmitter power, check the Status LED on the transmitter for any sign of system irregularities (*see Section 6.6.1 Transmitter Status Indications on page 43*). If the transmitter is in good working order the Status LED will display solid green for up to 2 seconds at power on (no faults detected).
3. Rotate the power switch key further to the START position and hold it there for up to 2 seconds (Status LED solid green). When the receiver MAIN relays are activated the Status LED will change from solid green to solid orange (system on). The power switch key will retract back to the ON (I) position when released. The same START position becomes an auxiliary function thereafter (*see Section 4.2.2.3 START + AUX Function on page 26*). Pressing any pushbutton before executing the START command at system startup will result in no signals transmitted (Status LED blinks orange).

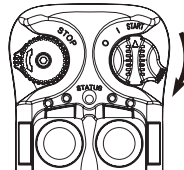

4. Press any pushbutton on the transmitter to begin operation. During transmitter inactivity (pushbuttons not pressed), the transmitter will automatically switch to standby mode, with an orange blink on the Status LED at 4-second intervals. Always turn off the transmitter power when not in use to save battery power.
5. In case of an emergency, press down the STOP button to disconnect the receiver MAIN relays (Status LED blinks 3 reds and then shuts off). To resume operation, rotate the STOP button clockwise or counterclockwise; the button will pop up. Then execute the START command to reconnect the receiver MAIN relays. For safety, executing the START command is required every time the transmitter is turned on or after every STOP button reset.
6. After 5 or 30 minutes of inactivity (pushbutton not pressed) the receiver MAIN relays are temporarily disconnected (*see Section 4.1.6 Transmitter Inactivity Timer Settings on page 20*). The Status LED blinks 3 reds and then shuts off. Press any pushbutton or execute the START command to resume operation (*see Section 4.1.5 Transmitter Start Function Settings on page 19*).

- Turn off the transmitter power by rotating the power switch key counterclockwise to the Off (0) position; it will disconnect the transmitter power and the receiver MAIN relays altogether. Turn it further counterclockwise to release the key.

6.2 A/B Pushbutton Select Operation

Pressing the “A/B” pushbutton repeatedly toggles between output relay A, B and A+B, respectively. There are 4 different types of Select A/B sequences available (*see Section 4.1.9.2 on page 22*).

Standard – Output relay A activated at A position, output relay B activated at B position, both output relays activated at A+B position.

Reversed logic – Output relay A activated at B position, output relay B activated at A position, both output relays deactivated at A+B position. *See Section 4.2.4 on page 32* for JP3 jumper settings.

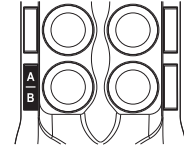

6.3 Pitch & Catch Operation

Press the “PITCH” pushbutton for up to 2 seconds to release control of the receiver. After 2-second grace period, rotate the power switch key to START position for up to 2 seconds to gain control of the receiver. The 2nd operator is unable to take control of the receiver unless the 1st operator presses the “PITCH” pushbutton. *See Section 4.2.2.9 on page 27* and *Section 4.2.3.2 on page 31* on how to set to this function.

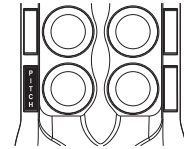

6.4 Changing Batteries

Change transmitter batteries (“AA” alkaline battery x 2) by unscrewing the battery cover located on the backside of the transmitter. During battery installation make sure the batteries are installed correctly, with “+” to “+” charge and “-” to “-” charge. Also make sure the screw is tightened after battery installation to avoid water, moisture, dirt, grease, and other liquid penetration.

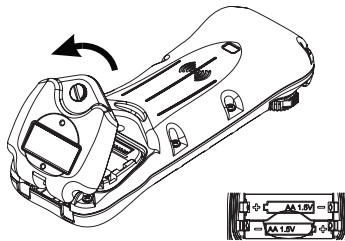

6.5 Battery Charging

The transmitter is designed to accept any off-the-shelf NiMH rechargeable batteries. When charging both transmitter and individual batteries at the same time the priority always goes to the transmitter charging. The individual battery charging begins only after the transmitter charging is completed. Depending on the battery capacity the average charging time is approximately 3 hours from completely drained to fully charged. Solid red on the LED represents charging in progress, solid green represents batteries fully charged, and LED off represents no batteries detected. Do not use any rechargeable lithium ion batteries as they will damage both the transmitter and the charging station.

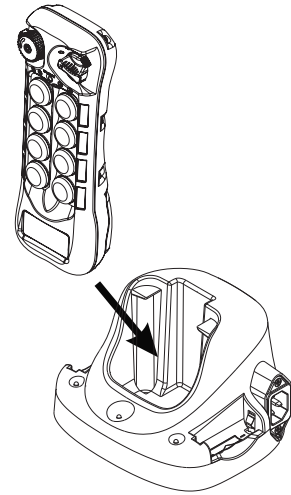

6.6 System Status Light Indications

6.6.1 Transmitter Status Indications

Type	Display Type	Indication
1	Solid red	Voltage below 1.8V at initial power on or during operation
2	3 red blinks and then off	Voltage below 1.75V during operation (receiver MAIN relays shut off)
3	1 red blink followed by a 2-second pause	Voltage below 1.85V during operation (changing batteries is recommended)
4A	2 red blinks followed by a 2-second pause	Defective or jammed pushbutton detected at initial power on
4B	No light displayed	When defective pushbutton condition occurs (2 red blinks, type 4A above), find out which pushbutton is defective by pressing all of them one at a time. If the pushbutton is in good working order when pressed, the Status LED is off. If the Status LED maintained 2 red blinks then the pushbutton is defective.
5	4 red blinks followed by a 2-second pause	Transmitter is unable to lock onto the assigned channel
6	Solid green for up to 2 seconds	Transmitter power on with no faults detected
7	Blinking green	Transmission in progress
8	Blinking orange	Pressing any pushbutton prior to executing the START command at power on
9	2 orange blinks followed by a 2-second pause	Receiver MAIN relays jammed or defective
10	3 orange blinks followed by a 2-second pause	Decoding processors defective
11	3 slow red blinks	STOP button pressed down
12	Solid orange when the power switch key is rotated and hold at the START position at initial system startup	Receiver MAIN relays activated

6.6.2 Receiver Status Indications

Type	Display Type (Green & Red)	Indication
1	Fast green blinks	Decoding in process
2	Slow green blinks	Decoding on standby
3	2 red blinks	Receiver MAIN relays jammed or defective
4	3 red blinks	Decoding processors defective
5	4 red blinks	Receiving RF board defective
6	Fast red blinks	Incorrect transmitter serial number
7	Solid red	Receiver low voltage
8	No light displayed	Decoding processors defective
9	3 slow red blinks followed by slow green blinks	STOP button pressed down

6.6.3 Receiver Power Indications

Type	Display Type (Red)	Indication
1	On	Power to receiver
2	Off	No power to receiver

6.6.4 Receiver COM Indications

Type	Display Type (Red)	Indication
1	On	Power to relay board
2	Off	No power to relay board

7 General Specifications

Frequency Range:	433.050MHz - 439.600MHz
Number of Channels:	62 channels
Channel Spacing:	50 KHz
Modulation:	Digital Frequency Modulation based on Manchester Code, 20-bit address, 32-bit CRC and Hamming Code.
Encoder & Decoder:	Microprocessor-controlled
Transmitting Range:	>100 meters (300 feet)
Hamming Distance:	>6
Frequency Control:	Synthesized PLL
Receiver Type:	Frequency Auto Scanning
Receiver Sensitivity:	-116 dBm
Spurious Emission:	-50 dB
Antenna Impedance:	50 ohms
Responding Time:	40 mS (average)
Transmitting Power:	1.0 mW
Enclosure Type:	NEMA4
Enclosure Rating:	IP66
Output Contact Rating:	250V @ 8 Amps
Transmitter Operating Voltage:	3.0VDC
Receiver Power Consumption:	8VA (max)
Available Receiver Voltages:	9 - 36VDC 24VAC 42VAC 48VAC 110 - 120VAC 220 - 240VAC 380 - 400VAC 410 - 460VAC
Operating Temperature:	-25°C - 75°C / -13°F - 167°F
Transmitter Dimension:	175 mm (L) x 70 mm (W) x 44 mm (H)
Receiver Dimension:	196 mm (L) x 149 mm (W) x 85 mm (H)
Transmitter Weight:	270 g / 9.5 oz (including batteries)
Receiver Weight:	1.76 kg / 3.8 lb (including output cable)

Distributed by Ergonomic Partners
Sales@ErgonomicPartners.com
www.ErgonomicPartners.com
Tel: (314) 884-8884