

# So Lite<sup>W</sup> C2

## Owner's Manual



**Welcome to Your New So Lite wheelchair!**

Please read this manual so you best know how to care for and safely operate it.

# SAFETY GUIDELINES

The symbols below are used throughout this owner's manual and on the So Lite wheelchair to identify warnings and important information.



**WARNING!** Indicates a potentially hazardous condition/situation. Failure to follow designated procedures can cause either personal injury, component damage, or malfunction. On the product, this icon is represented as a black symbol on a yellow triangle with a black border.



**MANDATORY!** These actions should be performed as specified. Failure to perform mandatory actions can cause personal injury and/or equipment damage. On the product, this icon is represented as a white symbol on a blue dot with a white border.



**PROHIBITED!** These actions are prohibited and should not be performed at any time or in any circumstances. Performing a prohibited action can cause personal injury and/or equipment damage. On the product, this icon is represented as a black symbol with a red circle and red slash.

**NOTE:** *This owner's manual is compiled from the latest specifications and product information available at the time of publication. We reserve the right to make changes as they become necessary. Any changes to our products may cause slight variations between the illustrations and explanations in this manual and the product you have purchased.*



Journey Health & Lifestyle  
Rev A/November 2023

# CONTENTS

<b>I.</b>	<b>INTRODUCTION</b>	<b>4</b>
<b>II.</b>	<b>SAFETY</b>	<b>5</b>
<b>III.</b>	<b>YOUR SO LITE WHEELCHAIR</b>	<b>13</b>
<b>IV.</b>	<b>OPERATION METHOD</b>	<b>17</b>
<b>V.</b>	<b>CARE AND MAINTENANCE</b>	<b>19</b>
<b>VI.</b>	<b>WARRANTY</b>	<b>22</b>
<b>VII.</b>	<b>APPENDIX I – SPECIFICATIONS</b>	<b>23</b>

# I. INTRODUCTION

## **SAFETY**

WELCOME to your new Journey Health and Lifestyle So Lite C2. This So Lite wheelchair combines state-of-the-art components with **safety**, comfort and styling in mind. We are confident that these design features will provide you with the conveniences you expect during your daily activities. Once you understand how to **safely** operate and care for your So Lite wheelchair, it should give you trouble-free operation and service for a long time to come.

**Read and follow** all instructions, warnings, and notes in this manual before attempting to operate your So Lite wheelchair for the first time. Please read all instructions, warnings and notes contained in any supplemental instructional booklets that accompanied your So Lite wheelchair. Your **safety** depends upon you, your caretaker or your health care professional, using good judgment.

If there is any information in this manual which you do not understand, or if you require additional assistance for setup or operation, please contact Journey Customer Service at 1-800-958-8324. **Failure to follow the instructions in this manual and those located on your So Lite wheelchair can lead to personal injury and/or damage to the So Lite wheelchair, as well as voiding the warranty.**

## **PURCHASER'S AGREEMENT**

By accepting delivery of this product, you agree that you will not change, alter, or modify this product or remove or render inoperable or unsafe any guards, shields or other safety features of this product; nor fail, refuse or neglect to install any retrofit kits from time to time provided by Journey to enhance or preserve the safe use of this product.

## **SHIPPING AND DELIVERY**

Before using your So Lite wheelchair, make sure your delivery is complete as some components may be individually packaged. If you do not receive a complete delivery, please contact Journey Customer Service immediately. Where damage has occurred during transport, either to the packaging or content, please contact the delivery company responsible.

## **INFORMATION EXCHANGE**

We want to hear your questions, comments, and suggestions about this manual. We would also like to hear about the safety and reliability of your new So Lite wheelchair, and about the service you received from our Customer Service agents.

Please notify us of any change of address, so we can keep you apprised of important information about safety, new and new options that can increase your ability to use and enjoy your So Lite wheelchair. Please feel free to contact us at the following address:

Journey Health & Lifestyle  
6800 Paragon Place - Ste. 520  
Richmond, Virginia 23230  
Tel: 1-800-958-8324  
[www.shopjourney.com](http://www.shopjourney.com)

***NOTE: If you ever lose or misplace your product registration card or your copy of this manual, contact us and we can send you a digital copy via email.***

## II . S A F E T Y

### PRODUCT SAFETY SYMBOLS

The symbols below are used on the So Lite wheelchair to identify warnings, mandatory actions, and prohibited actions. It is very important for you to read and understand them completely.



**Read and follow the information in the owner's manual.**



**Maximum seating weight.**



**Keep your hands away from the tires when driving. Be aware that loose-fitting clothing can become caught in drive tires.**



**Avoid exposure to rain, snow, ice, salt or standing water whenever possible. Maintain and store in a clean and dry condition.**



**Disposal and recycling - Contact your local mobility distributor or waste authority on proper disposal and recycling of your So Lite product and its packaging.**

# II . S A F E T Y

## GENERAL GUIDELINES



**MANDATORY! Do not operate your new So Lite wheelchair for the first time without completely reading and understanding this owner's manual.**

Your So Lite wheelchair is a state-of-the-art device designed to enhance your life by increasing your mobility. Journey provides an extensive variety of products to best fit the individual needs of the So Lite wheelchair user. Please be aware that the final selection and purchasing decision regarding the type of So Lite wheelchair to be used is the responsibility of the So Lite wheelchair user and their health care professional (i.e., medical doctor, physical therapist, etc.).

As you begin using your So Lite wheelchair during daily activities, you will probably encounter situations in which you will need some practice. Simply take your time, and you will soon be in full and confident control as you maneuver through doorways, on and off elevators, up and down ramps and over smooth terrain.

Below are some precautions, tips and other safety considerations that will help you become accustomed to operating your So Lite wheelchair safely:

- The So Lite Wheelchair arrives in 1 size, ready for use.
- Make sure to take your time to learn how So Lite Wheelchair works before you begin operating.
- Practice propelling and transferring in and out of the So Lite Wheelchair.
- Always be aware of your surroundings when self-propelling.
- Take it easy. If you're not sure the So Lite Wheelchair will surpass an obstacle, try to find another way around.
- The So Lite wheelchair is designed to be occupied by a single user. More than one user may result in personal injury to you and others.

### Modifications

Journey has designed and engineered your So Lite wheelchair to provide maximum mobility and utility. We offer a wide range of accessories to further customize your So Lite wheelchair to better suit your needs and/or preferences. However, under no circumstances should you yourself modify, add, remove, or disable any feature, part, or function of your So Lite wheelchair.



**WARNING! Do not modify your So Lite wheelchair in any way unless authorized by Journey. Do not use accessories if they have not been tested or approved as Journey products.**

### Pre-Ride Safety Check

Get to know the feel of your So Lite wheelchair and its capabilities. We recommend that you perform a safety check before each use to make sure your So Lite wheelchair operates smoothly and safely.

**Make sure to check the brakes prior to using your So Lite wheelchair. Also see Section V. "Care and Maintenance."**

**NOTE: If you discover a problem, contact Journey Customer Service for assistance.**

# II . S A F E T Y

## Weight Limitations

- Never exceed a total weight of 250 lbs for rider plus items carried.
- Exceeding the weight limit is likely to damage the seat, frame, or fasteners and may cause severe injury to you or others.
- Exceeding the weight limit will void the warranty.



**MANDATORY!** Stay within the specified weight capacity of your So Lite wheelchair. Exceeding the weight capacity voids your warranty. Journey will not be held responsible for injuries and/or property damage resulting from failure to observe weight limitations.

**WARNING!** Do not carry passengers on your So Lite wheelchair. Carrying passengers on your So Lite wheelchair may affect the center of gravity, resulting in a tip or a fall.



**WARNING!** The rear flap is for pocket items only such as cell phones, keys, and papers, and should not exceed 10 lbs total. There are no other storage areas on your So Lite wheelchair.

**WARNING!** Do not carry baggage weighing more than 10 lbs on the back of the So Lite wheelchair. Carrying or tying baggage in excess of 10 lbs on the back of the So Lite wheelchair may affect the center of gravity, resulting in a tip or a fall.

## Incline Information

More and more buildings have ramps with specified degrees of inclination, designed for easy and safe access. Some ramps may have turning switchbacks (180° turns) that require you to have good cornering skills on your So Lite wheelchair.

- Proceed with extreme caution as you approach the downgrade of a ramp or other incline.
- When driving down a ramp, proceed slowly to ensure a safely controlled descent.
- Make sure to take wide enough turns on tight corners to avoid bumping into them or any railing present



**WARNING!** When on any sort of an incline or decline, never allow the So Lite wheelchair to roll freely while seated on it or standing next to it.

**WARNING!** When climbing an incline, do not zigzag or drive at an angle up the face of the incline. Drive your So Lite wheelchair straight up the incline. This greatly reduces the possibility of a tip or a fall. Always exercise extreme caution when negotiating an incline.



**WARNING!** You should not travel up or down a potentially hazardous incline (i.e., areas covered with snow, ice, cut grass or wet leaves).

## II. SAFETY



**WARNING!** Even though your So Lite wheelchair is capable of climbing slopes greater than those illustrated in figure 1, do not, under any circumstances, exceed the incline guidelines or any other specifications presented in this manual. Doing so could cause tipping and instability in your So Lite wheelchair.

We recommend that the maximum slope of an incline you attempt to safely ascend or descend on your So Lite wheelchair does not exceed 5° (8.7%). See figure 1.



**WARNING!** Any attempt to climb or descend a slope steeper than 5° (8.7%) may put your So Lite wheelchair in an unstable position and cause it to tip.

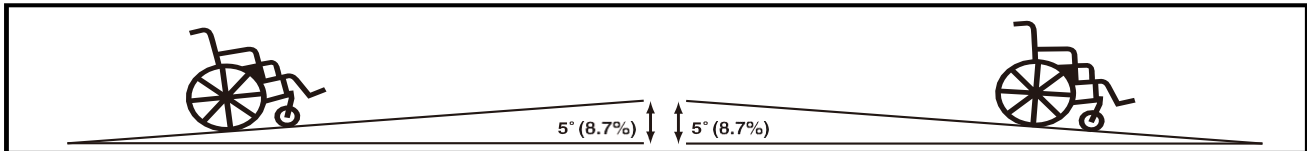

Figure 1. Maximum Safe Slope (Ascending and Descending)

### Braking Information

To stop the So Lite wheelchair, apply pressure to both handrims until the So Lite wheelchair comes to a complete stop.

### Manual Wheel Locks/Hand Brake

Your So Lite wheelchair is equipped with two manual wheel locks, one mounted on each drive wheel. The manual wheel locks help prevent your So Lite wheelchair from moving when parked. After you bring your So Lite wheelchair to a complete stop, engage both manual wheel locks. There are two types of manual wheel locks available on your So Lite wheelchair, you can squeeze the hand brakes or pull the front brakes until they engage with the tires. If you have any questions about the operation of your manual wheel locks, contact Journey Customer Service or your authorized Journey Provider.

**NOTE:** We do not recommend that you remain parked on an incline. The So Lite wheelchair may slide or the manual wheel lock may become disengaged.



**WARNING!** Do not attempt to use either manual wheel lock lever to stop your So Lite wheelchair.

### Cornering Information

While your So Lite wheelchair is equipped with front caster wheels, excessively high cornering speeds can still create the possibility of tipping. Factors which affect the possibility of tipping include, but are not limited to: cornering speed, steering angle (how sharply you are turning), uneven road surfaces, inclined road surfaces, riding from an area of low traction to an area of high traction (such as passing from a grassy area to a paved area – especially at high speed while turning) and abrupt directional changes. High cornering speeds are not recommended. If you feel that you may tip over in a corner, reduce your speed and steering angle (i.e., lessen the sharpness of the turn) to prevent your So Lite wheelchair from tipping.



**WARNING!** When cornering sharply, reduce your speed and maintain a stable center of gravity. This greatly reduces the possibility of a tip or fall.

### Public Streets and Roadways

**WARNING!** You should not operate your So Lite wheelchair on public streets and roadways. Be aware that it may be difficult for traffic to see you when you are seated on your So Lite wheelchair. Obey all local pedestrian traffic rules. Wait until your path is clear of traffic, and then proceed with extreme caution.



## II. SAFETY

### Outdoor Driving Surfaces

Your So Lite wheelchair is designed to provide optimum stability under normal driving conditions—dry, level surfaces composed of concrete, blacktop or asphalt.

- Avoid driving on uneven terrain and/or soft surfaces.
- Avoid tall grass that can entangle the running gear.
- Avoid loosely packed gravel and sand.
- Avoid uneven surfaces.
- Do not use your So Lite wheelchair in fresh or salt water.
- Do not use your So Lite wheelchair at the edge of a stream, lake or ocean.
- If you feel unsure about a driving surface, avoid that surface.

### Inclement Weather Precautions

Exposure of your So Lite wheelchair to inclement weather conditions should be avoided whenever possible. If suddenly caught up in rain, snow, severe cold or excessive heat while operating your So Lite wheelchair, proceed to shelter at the earliest opportunity. Thoroughly dry your So Lite wheelchair before storing or operating it again.



**PROHIBITED!** Operating in rain, snow, salt, mist/spray conditions and on icy/slippery surfaces can have an adverse effect on your So Lite wheelchair. Maintain and store your So Lite wheelchair in a dry and clean condition.



**WARNING!** Prolonged exposure to hot or cold conditions may affect the temperature of upholstered and non-upholstered items on the So Lite wheelchair, possibly resulting in skin irritation.

### Stationary Obstacles, Curbs, etc.

Proceed with extreme caution when driving near raised surfaces, unprotected ledges and/or drop-offs (curbs, porches, obstacles etc.). Be sure your So Lite wheelchair is traveling perpendicular to any curb you may be required to navigate. **See figure 2.**



**WARNING!** Do not attempt to have your So Lite wheelchair climb or descend an obstacle that is higher than 2 in. (5 cm) unless you have the assistance of an attendant.

**WARNING!** Do not attempt to have your So Lite wheelchair proceed backward down any step, curb or other obstacle. This may cause the So Lite wheelchair to tip.

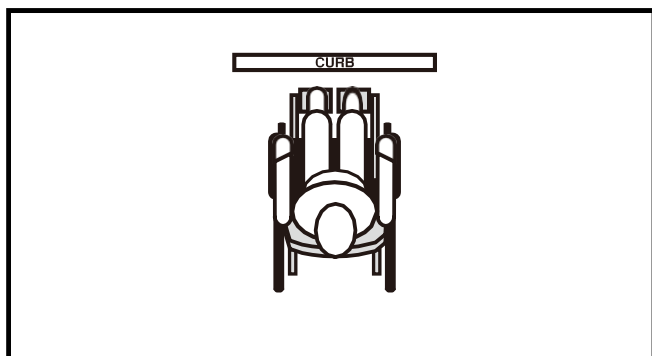

Figure 2. Correct Curb Approach



Figure 3. Incorrect Curb Approach

# II . S A F E T Y

## Obstacles and Escalators

So Lite wheelchairs are not designed to travel up or down stairs or escalators. Always use an elevator.



**WARNING! Never use your So Lite wheelchair to negotiate stairs or escalators.**

## Doors

- Drive your So Lite wheelchair gently and slowly forward to push the door open. Or drive your So Lite wheelchair gently and slowly backward to pull the door open.

## Elevators

Modern elevators have a door edge safety mechanism that, when pushed, reopens the elevator door(s).

- If you are in the doorway of an elevator when the door(s) begins to close, push on the rubber door edge or allow the rubber door edge to contact the So Lite wheelchair and the door will reopen.
- Use care that pocketbooks, packages or So Lite wheelchair accessories do not become caught in elevator doors.

## Lift Systems/Elevation Products

If you will be transporting your So Lite wheelchair during travel, you may find it necessary to use a vehicle-mounted lift system or elevation product to aid in transportation. Journey recommends that you closely review the warnings, instructions, specifications and safety information set forth by the manufacturer of the lift/elevation product before using that product.



**WARNING! Not all lift systems/elevation products are rated for use with an occupied mobility device. We recommend that you do not remain seated in your So Lite wheelchair when it is being used in connection with any type of lift system/elevation product unless:**

- That product is rated for occupied use by the manufacturer.
- You are able to occupy your mobility device in strict conformity with the warnings, instructions, specifications and safety guidelines set forth by the manufacturer.

## Motor Vehicle Transport

Do not remain seated in your So Lite wheelchair while traveling in a motor vehicle. Your So Lite wheelchair was designed to be folded and stored in a secure location, such as the trunk of a car, during motor vehicle transport. In addition, all removable So Lite wheelchair parts, including the armrests and front riggings, should be removed and/or properly secured during movement.



**WARNING! Do not sit on your So Lite wheelchair while it is in a moving vehicle.**

## Positioning Belts

Your authorized Provider, therapist(s), and other healthcare professionals are responsible for determining your need for a positioning belt in order to operate your So Lite wheelchair safely. Typically, the positioning belt is not designed for use as a restraining device in a motor vehicle. You should be properly belted into seats approved by the vehicle manufacturer with your So Lite wheelchair properly stowed for vehicle transport.



**WARNING! If you require a positioning belt to safely operate your So Lite wheelchair, make sure it is fastened securely in order to reduce the possibility of a fall from the So Lite wheelchair.**

**WARNING! The positioning belt is not designed for use as a seat belt in a motor vehicle. Nor is your So Lite wheelchair suitable for use as a seat in any vehicle. Anyone traveling in a vehicle should be properly belted into seats approved by the vehicle manufacturer.**

# II . S A F E T Y

## Reaching and Bending

Never reach, lean or bend while driving your So Lite wheelchair. It is important to maintain a stable center of gravity to prevent the So Lite wheelchair from tipping.



**WARNING! If you have to pick up objects from the floor, do not bend, lean or reach down between your knees, nor should you ever reach over the back of the seat. Movements such as these may change your center of gravity and the weight distribution of the So Lite wheelchair, which may cause your So Lite wheelchair to tip.**

**WARNING! Keep your hands away from the tires when driving. Be aware that loose-fitting clothing can become caught in drive tires.**

## Prescription Drugs/Physical Limitations

Users must exercise care and common sense when operating a So Lite wheelchair. This includes awareness of safety issues when taking prescribed or over-the-counter drugs or when the user has specific physical limitations.



**WARNING! Consult your physician if you are taking prescribed or over-the-counter medication or if you have certain physical limitations before using the So Lite wheelchair. Some medications and limitations may impair your ability to operate your So Lite wheelchair in a safe manner.**

## Alcohol/Smoking

The So Lite wheelchair user must exercise care and common sense when operating their So Lite wheelchair. This includes awareness of safety issues while under the influence of alcohol or while smoking.

**WARNING! Do not operate your So Lite wheelchair while you are under the influence of alcohol, as this may impair your ability to operate your So Lite wheelchair in a safe manner.**



**WARNING! We strongly recommend that you do not smoke cigarettes while seated in your So Lite wheelchair, although the So Lite wheelchair has passed the necessary testing requirements for cigarette smoking. You must adhere to the following safety guidelines if you decide to smoke cigarettes while seated in your So Lite wheelchair:**

- **Keep ashtrays a safe distance from the seat cushions.**
- **Do not leave lit cigarettes unattended.**

## II . S A F E T Y

### Attention to safety

- Don't incline forward when driving, especially on hills, a raised obstacle or uneven road.
- Put your feet on the footrest.
- When climbing the hill or obstacle, the person who pushes the So Lite wheelchair must step on the footrest, hold the handles and press down, then push the So Lite wheelchair forward.

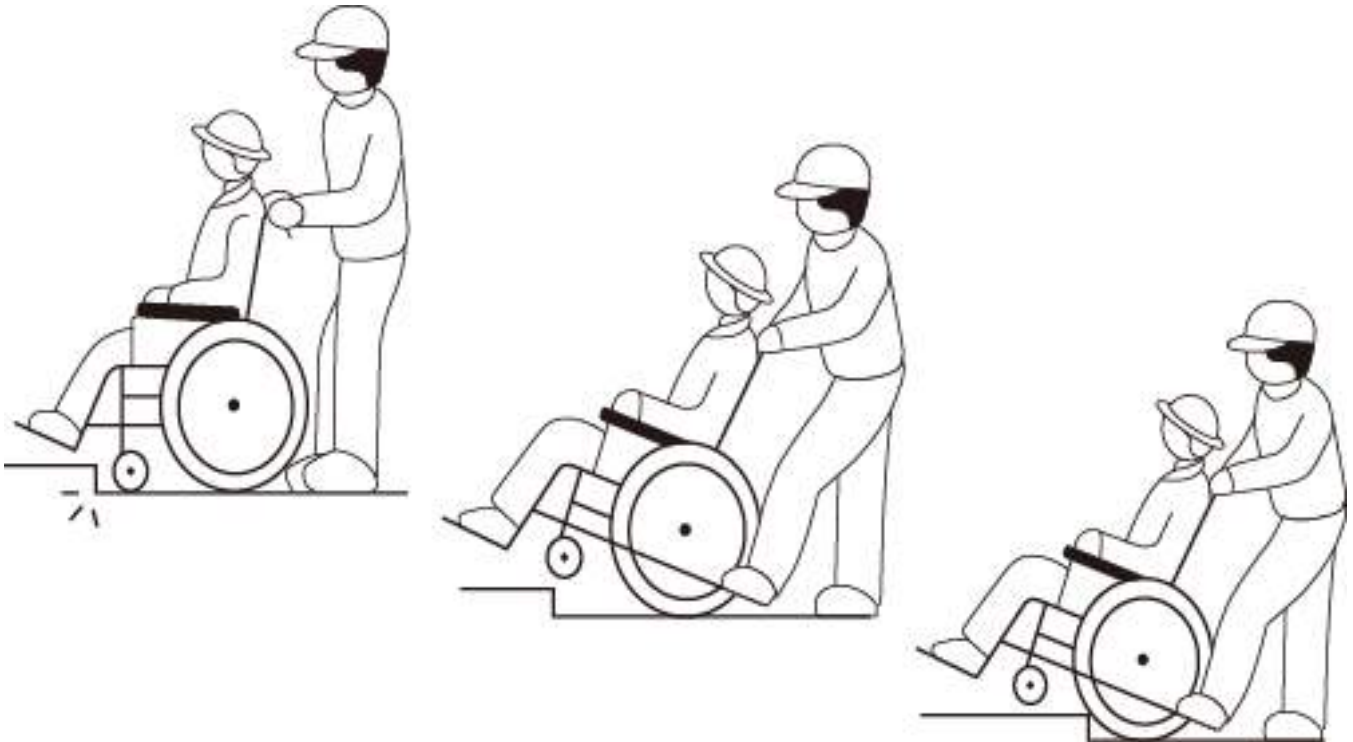

- Keep straight when passing over a step or obstacle. Be careful not to clip the tires, as that could be dangerous.
- Drive right-angled when crossing grooves and do not clip the tires in the groove.
- Avoid sudden braking to prevent tumbling.
- Be careful when driving and parking on a ramp.

## III. YOUR WHEELCHAIR

### The So Lite C2

The So Lite C2 is a rear-wheel self-propelled wheelchair designed to operate both indoors and outdoors on smooth surfaces.

---



Figure 4. So Lite wheelchair

**The maximum capacity of this So Lite wheelchair is 250lbs.**

# III. YOUR WHEELCHAIR

## Unfolding the seat

Release the brake, stand at the front or back of the So Lite wheelchair, hold armrests and pull hard, one hand on the armrests and the other one pressing down on the seat. See figures 5 and 6



**WARNING! Be careful of your hands.**

## Folding the seat

Folding the footrest first, then hold both ends of the seat, lift up the seat from the middle. Press down both side of the armrest. See figure 7.

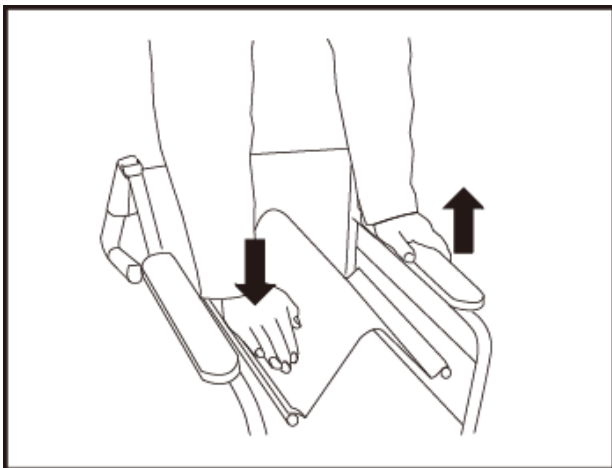

Figure 6.

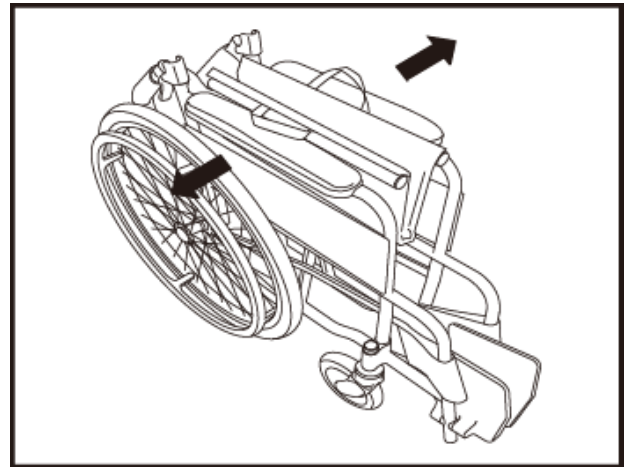

Figure 5.

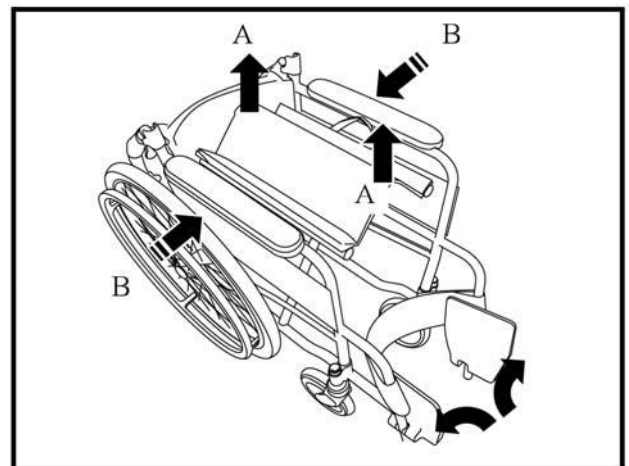

Figure 7.

## Flip up armrest

armrest can be flipped up for more compact storage. See figure 8.

Armrest latch

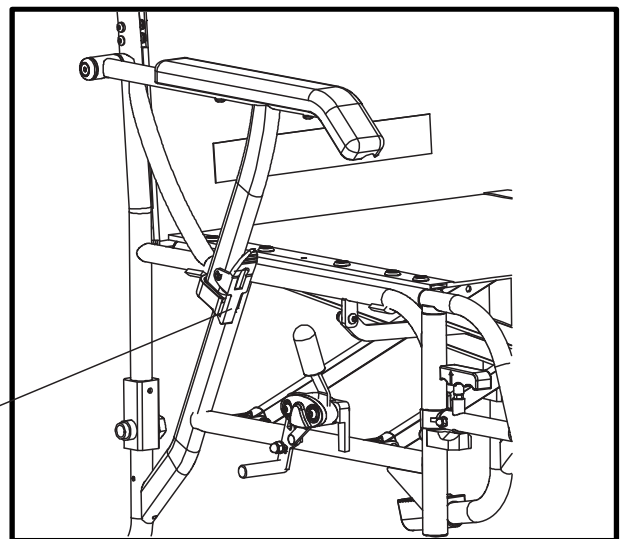

Figure 8.

# III. YOUR WHEELCHAIR

## Installation of curb climber wheel

According to Figure 9, the curb climber wheel is already inserted into the rear pipe hole of the frame.



Curb Climber Wheel

Figure 9

# III. YOUR WHEELCHAIR

## Opening of the backrest

Hold the handle and lift up. See figure 10.



**WARNING! Be careful of your hands.**



### Attention

- Hold the handle and move upwards and forwards; confirm that the backrest is folded properly.
- Be mindful of your hands. .

## Folding of the backrest

Hold the handle with one hand and press the back, folding button with the other one. See figure 11.

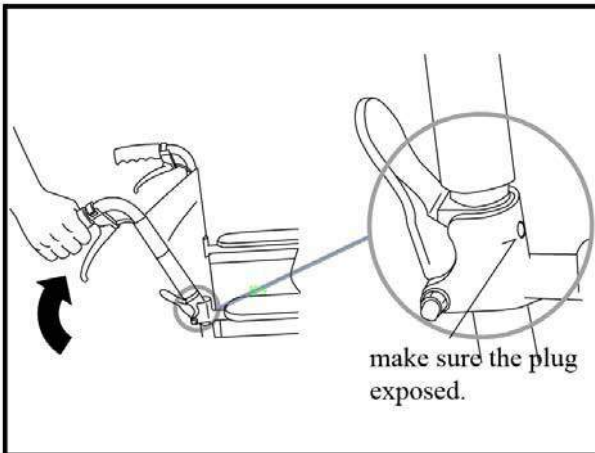

Figure 10.

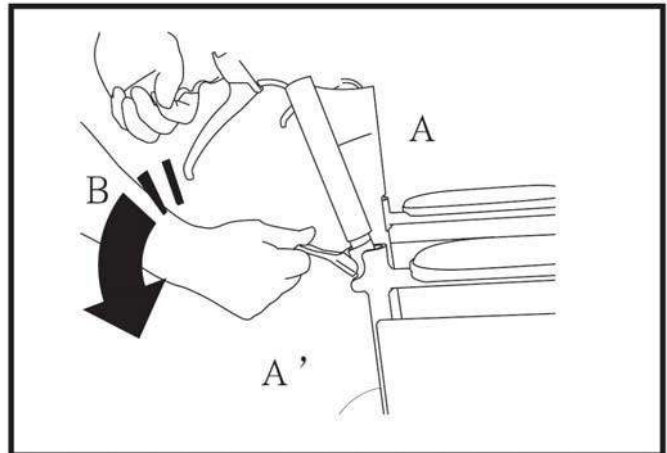

Figure 11.



## IV. OPERATION METHOD

### Driving Method

Self-propelled driving: Bend both arms so there is tension when you grasp the handrim of the wheels, apply even pressure and push both hands forward to begin rolling your So Lite wheelchair

Having someone push your So Lite wheelchair: Hold the handle. Push the So Lite wheelchair forward.

### Brake Method

Your So Lite wheelchair is equipped with two manual wheel locks, one mounted on each drive wheel. The manual wheel locks help prevent your wheelchair from moving when parked. After you bring your wheelchair to a complete stop, engage both manual wheel locks. There are two types of manual wheel locks. You can squeeze the hand brakes or pull the front brakes until they engage with the tires. **See Figure 12.**

Figure 12.

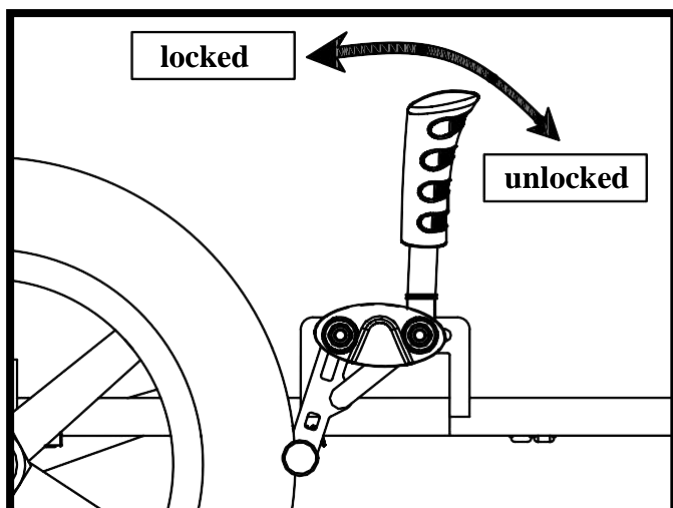

# IV. OPERATION METHOD

## Ways To Drive with the Help of a Caregiver

- A caregiver simply holds the handles and pushes the So Lite wheelchair along the pavement.
- Keep the So Lite wheelchair from leaning to one side when driving on rough pavement, try to avoid that road roughness.



- When encountering an obstacle, caregiver stops at the obstacle, holds the handles with both hands, and, while stepping on the curb climber pedal at the back of the chair, presses the handles down.



- Caregivers pushing the So Lite wheelchair should lean forward when going uphill and keep the same posture to go backward downhill.

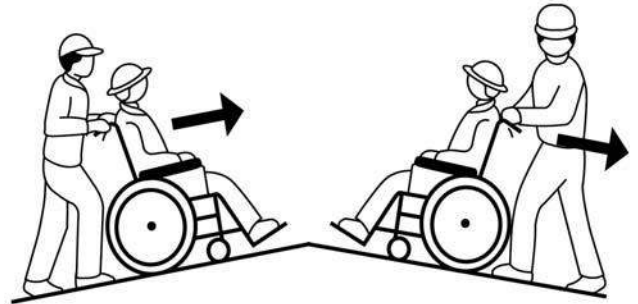

- Cross a groove at a slight angle to prevent tires from getting hung up in the grid. Drive straight ahead. When crossing grating unless it appears wide enough to trap the front wheel, then go around.

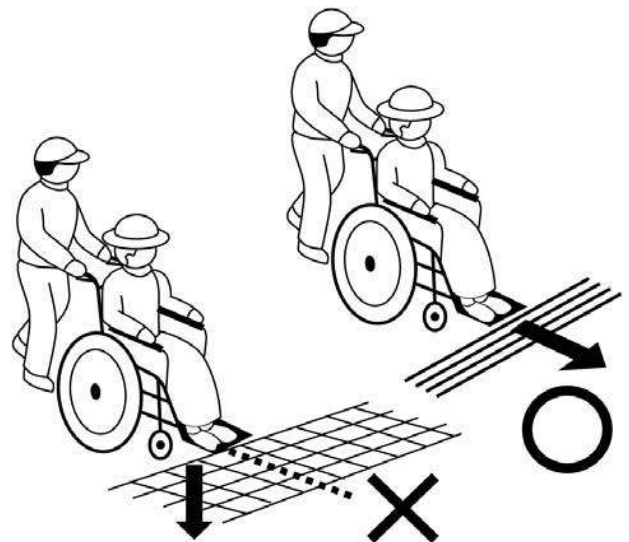

# V. CARE AND MAINTENANCE

## Care and Maintenance

Your So Lite C2 requires routine maintenance checks. Preventive maintenance is very important. If you follow the maintenance checks in this section as scheduled, you can help ensure that your So Lite wheelchair gives you years of trouble-free operation. If you have any doubt as to your So Lite wheelchair's care or operation, contact Journey Customer Service.



**WARNING! Do not service the So Lite wheelchair when the seat is occupied.**

Your So Lite wheelchair is susceptible to damage from the elements. Avoid damp areas of any kind.



**WARNING! Direct or prolonged exposure to water or dampness could cause the chair's frame to rust or corrode, or cause the chair to malfunction mechanically. The chair should be examined periodically for signs of corrosion caused by water exposure or bodily fluids exposure, such as incontinence. Damaged components should be replaced or treated immediately.**

## Should your So Lite wheelchair come in contact with water:

1. Dry your So Lite wheelchair as thoroughly as possible with a towel.
2. Allow your So Lite wheelchair to sit in a warm, dry place for 12 hours to allow unseen water to evaporate.
3. If any damage or problems are found, call Customer Service or take your So Lite wheelchair to your authorized Journey Provider. So Lite wheelchairs that are frequently exposed to sources of water, such as incontinence, should be inspected often for corrosion.

## Temperature

Some of the parts of your So Lite wheelchair are susceptible to extreme changes in temperature. Always keep your wheel-chair between the temperatures of 18° F (-8° C) and 122° F (50° C).

## General Guidelines

- Avoid prolonged exposure of your So Lite wheelchair to extreme conditions, such as heat, cold or moisture.
- Use a rubber conditioner on the tire sidewalls to help preserve them.



**WARNING! Never use a rubber conditioner on the tread area of the tires; doing so may make the tires slippery and cause your So Lite wheelchair to skid.**

- All wheel bearings are pre-lubricated and sealed. They require no subsequent lubrication.

## **Daily Checks**

- Check for loose or missing screws, nuts and bolts. Replace or tighten them as necessary.
- Check the tires. Look for uneven wear, holes or tire/rim separation. If they look excessively worn, then have them replaced.
- Check for flat spots on solid tires. Flat spots could adversely affect stability.
- Check the handrims. Make sure that they are fastened securely to the wheels.
- Check the manual wheel locks. Make sure they work properly. If they do not, instructions on how to adjust them are provided in this manual.

# V. CARE AND MAINTENANCE



**WARNING! The manual wheel locks are designed to keep your chair stationary while you are parked. They are not designed to stop the So Lite wheelchair during driving. Do not use either of the manual wheel locks to stop the So Lite wheelchair while driving it. This can cause your So Lite wheelchair to become unstable and tip.**

## Monthly Checks

- Check for drive tire wear.
- Check the caster wheels for wear.
- Check the caster forks for damage or fluttering, which indicates that they may need to be adjusted or have the bearings replaced.
- Keep your So Lite wheelchair clean and free of foreign material such as mud, dirt, hair, food, drink, etc.

## Storage

Your So Lite wheelchair should be stored in a dry place, free from temperature extremes.



**WARNING! If you fail to store the unit properly, the frame can rust.**

You may wish to place several boards under the frame of your So Lite wheelchair to raise it off the ground during periods of prolonged storage. This takes the weight off the tires and reduces the possibility of flat spots developing on the areas where the tires contact the ground.

## Disposal of Your So Lite wheelchair

Your So Lite wheelchair must be disposed of according to applicable local and national statutory regulations. Contact your local waste disposal agency, Customer Service or your authorized Journey Provider for information on proper disposal of So Lite wheelchair packaging, metal frame components, plastic components, neoprene, silicone and polyurethane materials.

## Cleaning and Disinfection

Use a damp cloth and mild, non-abrasive cleanser to clean the plastic and metal parts of your So Lite wheelchair. Avoid using products that may scratch the So Lite wheelchair surface. If necessary, clean your product with an approved disinfectant. Make sure the disinfectant is safe for use on your product before application.



**WARNING! Follow all safety instructions for the proper use of the disinfectant and/or cleaning agent before applying it to your product. Failure to comply may result in skin irritation or premature deterioration of upholstery and/or So Lite wheelchair finishes.**

**WARNING! Never hose off your So Lite wheelchair or place it in direct contact with water. Your So Lite wheelchair has a painted finish that allows it to be easily wiped clean with a damp cloth.**

**WARNING! Never use any chemicals to clean a vinyl seat, as they may cause the seat to become slippery**

# VI . W A R R A N T Y

Journey Health & Lifestyle warrants this product, so far as the same is of its own manufacture, to be free of defects in material and workmanship, when used by the purchaser under normal conditions, for (1) year after purchase. The side frames and cross-frames are warranted for the life of the product to the original purchaser.

The warranties herein specified shall not apply if the failure of any component of this product to satisfy such warranty is due to accident, neglect, misuse, improper transportation arranged by the purchaser or its agent, or causes other than ordinary use including operation contrary to Journey's operating instructions or if any person other than Journey's authorized personnel shall modify, adjust or repair such product or perform any related service on it.

It must be understood that the purchaser assumes full responsibility for the overall safe operation in the environment for which the product is intended to function.

For one (1) year from the date of purchase, Journey will repair or replace at our option to the original purchaser free of charge, any of the following parts found upon examination by an authorized representative of Journey to be defective in material and/or workmanship:

- Main frame sub-assemblies (fork, caster beams, metal seat base, metal arms, metal foot plate)
- Plastic components, except body
- Rubber components (bearings and bushings, caster and curb climbers wheels)

## **Warranty Exclusions**

- ABS plastic body shrouds and footrest covers are wear items and not warranted.
- Tires and tubes
- Upholstery and seating
- Repairs and/or modifications made to any part without specific prior written consent from Journey
- Circumstances beyond the control of Journey
- Labor, service calls, shipping and other charges incurred for repair of the product unless specifically authorized by Journey

## **Damage Caused By:**

- Abuse, misuse, accident or negligence
- Improper operation, maintenance or storage
- Commercial use, or use other than normal

# APPENDIX I - SPECIFICATIONS

Model	08970 BLK/CFR
Overall dimension(L×W×H)(inch)	42×27×36.5
Folded width (inch)	13
Folded height (inch)	29.5
Seat width (inch)	17.7
Seat depth (inch)	17
Seat surface height at front edge (inch)	18.9
Armrest height (inch)	7.8
Distance between armrests (inch)	19.6
Backrest height (inch)	16
Foot plate height above ground (inch)	4.3
Total wheelchair weight (lbs.)	24
Loading capacity (lbs.)	240
Front wheel dimension (inch)	6"
Rear wheel dimension (inch)	20"
Minimum turning radius (inch)	≤33



**Journey Health & Lifestyle**

6800 Paragon Place - Ste. 520

Richmond, Virginia 23230

Tel: 1-800-958-8324

[www.shopjourney.com](http://www.shopjourney.com)