

Owner's Manual



➤ S731A

➤ S741A

Table of Contents

Introduction

Practice before Operating	2
---------------------------------	---

Safety Instructions

Safety Considerations	4
Driving Outdoors	7
Use caution when driving on inclines	9

Familiarize Yourself with your Scooter

The Batteries	11
Feature Diagram	12
Terminology	13
Disassembly and Assembly Base step of the scooter	14

Operating your Scooter

Controls	17
Tiller Angle Adjustment	19
Free Wheel Mode	19

Technical Specifications- S731A, S741A	20
---	-----------

Simple Exploded Drawing & List	21
---	-----------

ICE Symbols	22
--------------------------	-----------

Warranty

Merits Limited Warranty	23
-------------------------------	----



Welcome aboard your new scooter, and thank you for choosing our product. Please read this manual carefully, and follow all instructions before attempting to operate your scooter for the first time. If there is anything in this manual that you do not understand, or if you require additional assistance for setting up your scooter, please contact your local dealer.

This latest model is designed for specific practical user needs, combining solid, rugged construction, and modern high-tech electronics, to enhance safety and performance.

With a state-of-the-art, programmable electronic control system, your scooter can be programmed and adjusted within a given range of its performance characteristics, to suit your individual needs. The controller is set up at the factory to give the scooter nominal operating performance characteristics.

After becoming familiar with the basic operation of the scooter, you may wish to customize the settings to fit your own personal preferences. A wide range of customization options can be adjusted such as acceleration, deceleration, maximum speed, turning speed, safety controls, and so on. Contact your local dealer for advice on additional equipment you may need.

Having your scooter checked regularly by your local dealer is the best way to ensure smooth operation and safety.

This manual provides users practical tips and information on safety issues, operation, and maintenance. Please read it very carefully to ensure your maximum enjoyment and to fully benefit from your independence and mobility.

Whenever special advice or attention is needed, please contact your local dealer, who has the tools and know-how to provide expert servicing for your scooter.

Your satisfaction and opinions are highly valued by both your local dealer and Merits. Please be sure to fill out the enclosed warranty registration form, and return it to your local dealer. The information is necessary for providing you with the best service, and to be sure all of your needs are met.

Failure to follow these instructions may result in damage to the scooter or serious injury.

■ Practice Before Operating

Find an open area such as a park and have an assistant to help you practice until you have confidence operating this vehicle.

Make sure the unit is OFF before getting on or off. Set the speed control knob according to your driving ability.

We recommend that you keep the speed at the slowest position (fully counter-clockwise) until you are familiar with the driving characteristics of this vehicle.

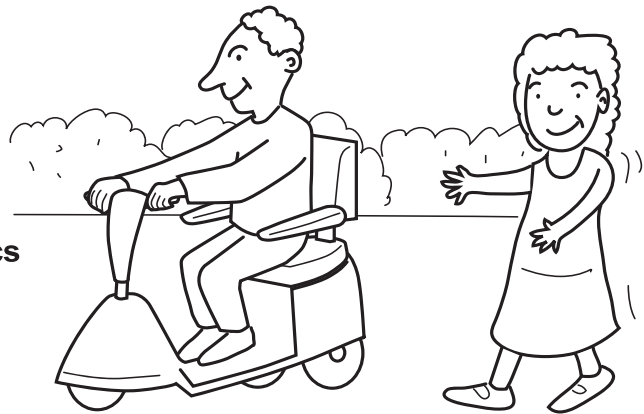

Stop, forward, and reverse operation practice

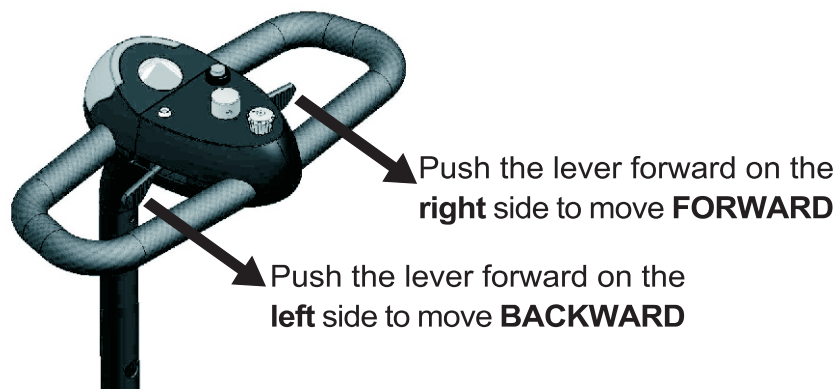

Getting familiar with this vehicle

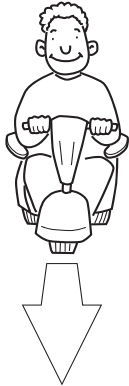

**First, practice moving forward.
Be sure to set the speed to the lowest setting.**

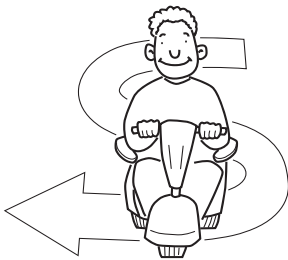

**After becoming familiar with moving forward,
practice making "S" turns.**



**Once you are familiar with "S" turns, practice
moving in reverse. Note that at any speed control
setting, the vehicle moves more slowly in reverse
than forward**

■ Safety Considerations

DO NOT do any of the following



NO!
Do not carry any passengers



NO!
Do not drive across a slope



NO!
Do not drink and drive
Consult your physician to determine if your medications impair your ability to control this vehicle



NO!
Do not tow a trailer



NO!
Do not turn on or use hand-held personal communication devices such as citizens band(CB) radios and cellular phones

This vehicle has an immunity level of 20 V/m which should protect it from Electromagnetic Interference(EMI) from Radio Wave Sources. The rapid development of electronics, especially in the area of communications, has saturated our environment with electromagnetic (radio) waves that are emitted by television, radio and communication signals. These EM waves are invisible and their strength increases as one approaches the source. All electrical conductors act as antennas to the EM signals and, to varying degrees, all power wheelchairs and scooters are susceptible to electromagnetic interference (EMI). This interference could result in abnormal, unintentional movement and/or erratic control of the vehicle. The United States requires the preceding statement be incorporated into the user manuals for all electric powerchairs and scooters.

Powered wheelchairs and electric scooters (in this text, both will be referred to as powered wheelchairs) may be susceptible to electromagnetic interference(EMI), which is interfering electromagnetic energy emitted from sources such as radio stations, TV stations, amateur radio (HAM) transmitters, two-way radios and cellular phones. The interference (from radio wave sources) can cause the powered wheelchair to release its brakes, move by itself or move in unintended directions. It can also permanently damage the powered wheelchair's control system. The intensity of the EM energy can be measured in volts per meter (V/m). Each powered wheelchair can resist EMI up to a certain intensity. This is called the "immunity level." The higher the immunity level, the greater the protection. At this time, current technology is capable of providing at least 20 V/m of immunity level which would provide useful protection against common sources of radiated EMI.

Following the warnings listed below should reduce the chance of unintended brake release or powered wheelchair movement that could result in serious injury:

- 1) Do not turn on hand-held personal communication devices such as citizens band (CB) radios and cellular phones while the powered wheelchair is turned on.
- 2) Be aware of nearby transmitters such as radio or TV stations and try to avoid coming close to them.

- 3) If unintended movement or brake release occurs, turn the powered wheelchair off as soon as it is safe.
- 4) Be aware that adding accessories or components, or modifying the powered wheelchair, may make it more susceptible to interference from radio wave sources. (Note: there is no easy way to evaluate their effect on the overall immunity of the powered wheelchair).
- 5) Report all incidents of unintended movement or brake release to the powered wheelchair manufacturer, and note whether there is a radio wave source nearby.

TURN OFF YOUR SCOOTER AS SOON AS POSSIBLE WHEN EXPERIENCING ANY OF THE FOLLOWING:

1. Unintentional motions.
2. Unintended or uncontrollable direction.
3. Unexpected brake release.

The FDA has written to the manufacturers of power wheelchairs, asking them to test their new products to ensure they provide a reasonable degree of immunity against EMI. The letter states that powered wheelchairs should have an immunity level of at least 20 V/m, which provides a reasonable degree of protection against the more common sources of EMI. The higher the level, the greater the protection.

■ Driving Outdoors

When driving outdoors, please avoid the following:

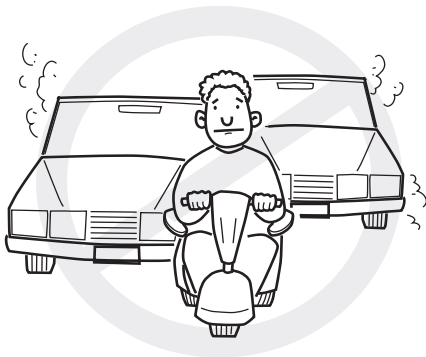

NO!

Do not drive in traffic.



NO!

Do not drive beside a river, port, or lake without a fence or railing.



NO!

If possible, do not drive during the rain.



NO!

If possible, do not drive during or on snow.



NO!

Do not drive off-road or on any uneven surfaced roads.



NO!

If possible, do not drive at night.



NO!

Make sure there are no obstacles behind you when in reverse.

We recommend to set the speed knob at the lowest speed for reversing.



NO!

Do not make sudden stops, weave erratically, or make sharp turns.



NO!

Keep your arms on or inside the armrests and feet on the footrest at all time.



NO!

Do not attempt to climb curbs greater than 1.5"(4cm).



NO!

Do not attempt to cross over a gap greater than 3"(7.5cm).

■ Use caution when driving on inclines

Driving on inclines is more dangerous than on level surfaces. If you fail to heed these warnings, a fall, tip-over or loss of control may occur and cause severe injury to the vehicle user or others.



NO!

Do not attempt to climb an incline greater than 8°



NO!

Do not reverse while driving up an incline.

Forward only. If you reverse while moving up an incline, it may cause the vehicle to tip over.



NO!

Do not attempt to drive across a sloping surface greater than 3°

Driving across a slope greater than 3° is very dangerous and may cause the vehicle to tip over.



NO!

Use caution when driving over soft, uneven or unprotected surfaces such as grass, gravel and decks.



NO!

Use low speed while driving down an incline.

When going down an incline, the tiller will become harder to reach and handle. When braking while moving down an incline, the scooter will take longer to come to a complete stop.



NO!

Do not get on or off on an incline.

Always stop on a level surface to get on or off of the vehicle.



NO!

Do not load or carry heavy items in the basket while driving down an incline.

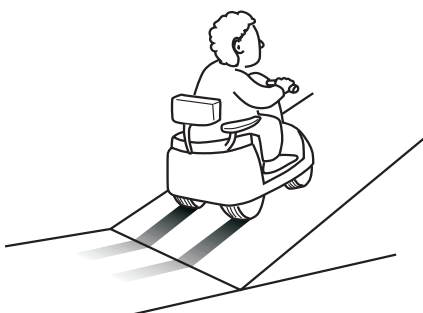

YES!

Always climb or descend gradients perpendicular to the slope or ramp.

■ The Batteries

Your scooter is equipped with a removable battery pack, which contains two maintenance free, sealed lead-acid batteries. These batteries require no maintenance other than ensuring they are properly charged. If other batteries are used, check with your battery supplier for proper battery care and maintenance instructions.

Charging the Batteries

Because your batteries may only have a partial charge when you first receive your scooter, you may not experience full riding time until you have fully charged them. Your scooter is equipped with either an on-board or an off-board battery charger. Charging your batteries as specified below will ensure maximum life, power, and range.



WARNING: Use of a non-grounded receptacle could result in an electric shock

Off-Board Battery Charger

1. Turn off the power on the scooter.
2. Slide away the cover of the battery receiver socket and insert the battery charger socket.
3. Do not switch on the battery charger until all the plugs are in position.
4. Battery charger when starting its charge will show an amber light. The charge is complete when the charging light turns to green.

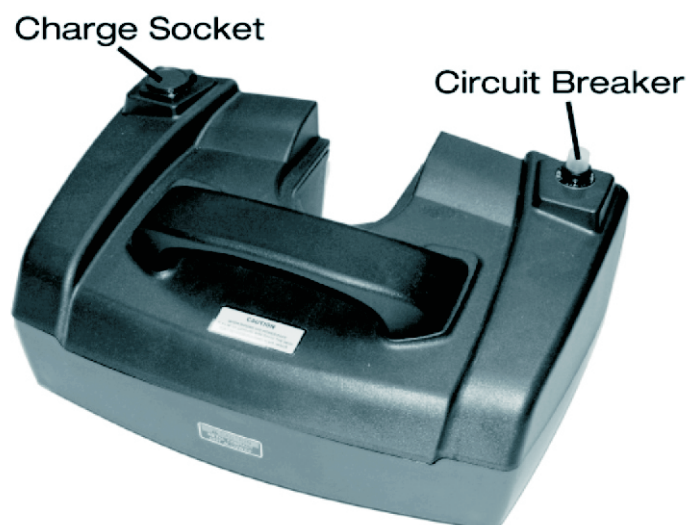

S731A, S741A

■ Feature Diagram

In this section, we will acquaint you with the many features of your micro portable scooter and how they work. Upon receipt of your micro portable scooter, inspect it for any damage. Your micro portable scooter consists of the following components.



S731A



S741A

1. Tiller
2. Key Switch
3. Wig-Wag Control Lever
4. Seat Assembly
5. Removable Battery Pack
6. Rear Shroud

7. Anti-Tip Wheels
8. PU tires (Rear Wheel)
9. Front Shroud
10. PU tires (Front Wheel)
11. Tiller Angle Adjustment Knob
12. Basket

■ Terminology

1. **Tiller** - Similar in operation to the handlebars of a bicycle, this device is used to steer the vehicle. It also contains the controls necessary to propel and control the vehicle.
2. **Operator's Seat** - This adjustable seat can be swiveled to ease mounting / dismounting to / from the vehicle and can be removed for easier transportation of the vehicle.
3. **Arm-Rests** - are width and angle adjustable. (see seating adjustments later in this manual).
4. **Seat Swivel Release Lever** - allows the seat to be swiveled in 45 degree increments. Seat must be locked in the forward facing position when operating the vehicle.
5. **Anti-tip Wheels** - Not visible in figure but positioned one each side of the vehicle at the rear, these wheels prevent a tip-over backwards.
6. **Manual brake Release** - This lever must be in the forward position to drive the vehicle. In this position the electric brake is controlled by the vehicle controller and will be released for drive and engaged when stopped. On occasions when it is desirable to push the vehicle, this lever is moved to the rearward position to permanently hold the brake release. When the Manual Brake Release lever is in the rearward position, the vehicle can not be driven under power.
7. **Key Switch** - This is used to turn vehicle power to ON and to OFF. The key can only be removed from the lock when the power is set to OFF.
8. **Wig-Wag Control Lever** - this is used to control the speed and direction of drive.
9. **Removable Front Basket** - This basket clips to the front of the tiller and is used to carry small personal items.
10. **Removable Battery Pack** - This pack holds the two 12 volt batteries and the battery charger. This module can be removed from the vehicle to reduce the vehicle weight when you intend to lift the vehicle into (say) the trunk of an automobile.

S731A, S741A

■ Disassembly and Assembly of the scooter

This scooter can be separated into five parts, the front frame, rear frame, basket, battery pack, and the seat. Each part weighs less than 31lb. Follow the procedures below to disassemble your scooter and transport it with care.

1. Front Section
2. Rear Section
3. Battery Pack
4. Seat
5. Basket



Disassembly of the scooter

This scooter can be separated into five parts, the front section, rear section, basket, battery pack, and the seat. Each part weighs less than 31lb . Follow the procedures below to disassemble your scooter and transport it with care.

Step 1: Remove the seat (pull up on seat release and remove it)

Step 2: Remove the battery pack (Pull away the black clasp then raise the handle and lift out the battery pack.)

Step 3: Separate the front and rear section (Push the black clasp to separate two sections.)

Assembly of the scooter

Step 1 : Combine the front section and rear section

Please make sure the front and rear section are really aligned

Step 2 : Replace the battery pack

Ensure the battery pack is properly aligned and the release mechanism/clasp is securely fastened.

S731A, S741A

Transportation:

Lifting the front wheel off the ground and leaving the rear wheels grounded, allows a single person to drag the scooter. Or, one person can lift the front end of the scooter while another lifts the rear to carry the scooter.



Tiller Angle Adjustment

■ Controls Diagram

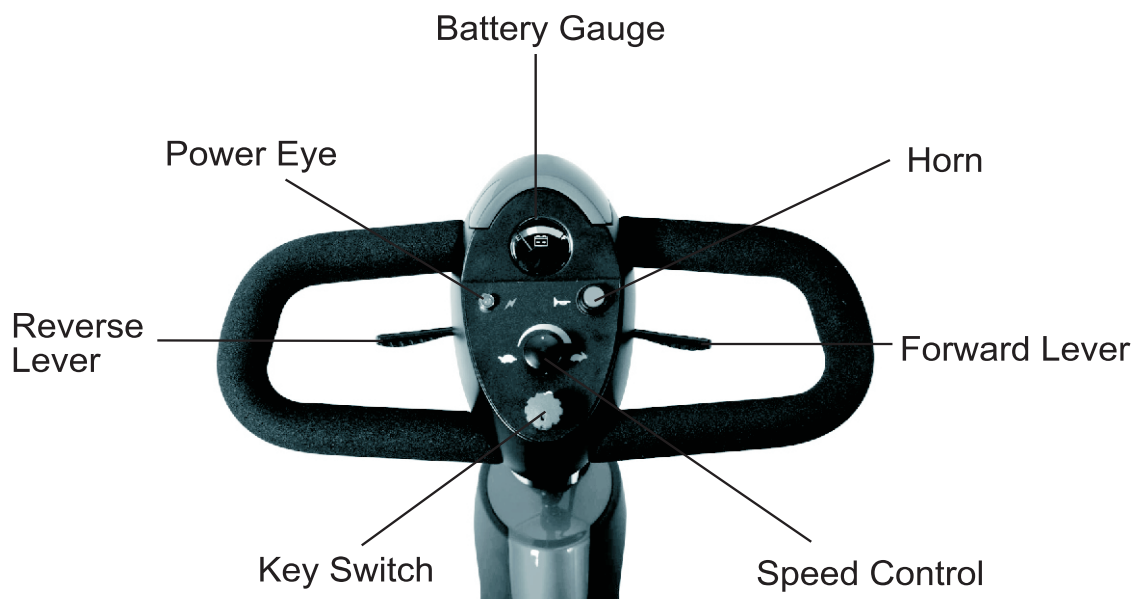

■ Controls

Only drive within your control limitations. Loss of control of your scooter could result in serious injury to yourself or others. If your speed becomes difficult to control, release the speed engager lever and your scooter will come to a complete stop. Only use the on/off switch to stop your scooter in an emergency.

Key Switch:

- Fully insert the key into the key switch to power up (turn on) your scooter.
- Remove the key from the key switch to power down (turn off) your scooter.

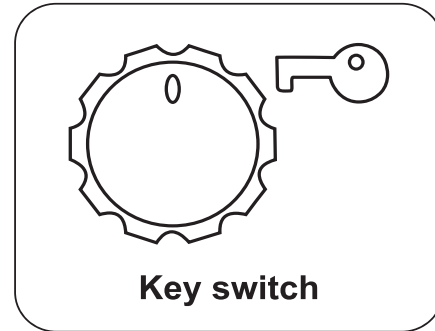

Speed Control:

Speed Dial regulates the speed of the scooter. Start at the slowest speed until you feel confident controlling your scooter safely. Turn the speed dial counter-clockwise to decrease the speed. Turn the speed dial clockwise to increase the speed.

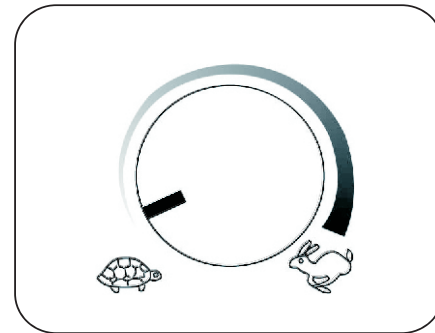

Forward / Reverse:

To move forward push the lever on the right side. To move backwards push the lever on the left side.

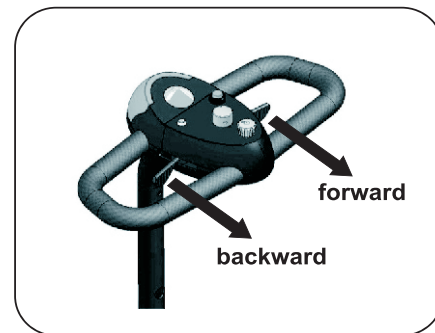

Battery Gauge:

Indicates the charge level of the batteries. If the needle goes into the red area, the batteries need to be charged as soon as possible. If the needle is all the way to the right side of the green area, the batteries are fully charge. As the needle moves to the red area it indicates the depletion level.

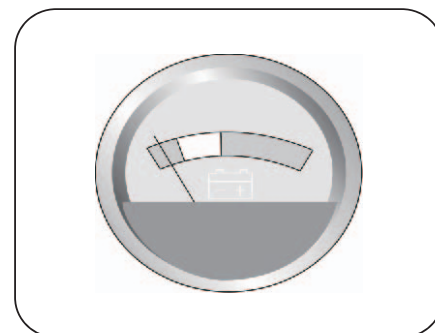

S731A, S741A

Horn:

The horn is activated by pressing the horn button. The horn is useful to warn people or animals that you are coming towards them. You may also find it helpful to use when rounding blind corners or reversing.

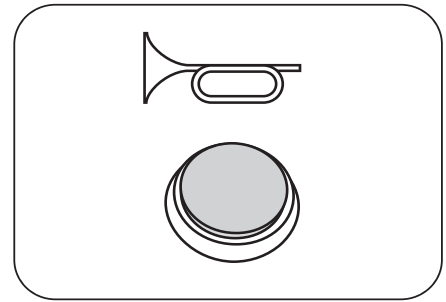

Power eye:

When the scooter is on, and all conditions are normal, the Power Eye will be on. When there is some special situation that needs attention, the light will flash. See the reference chart below for the meanings of the different flashing patterns.

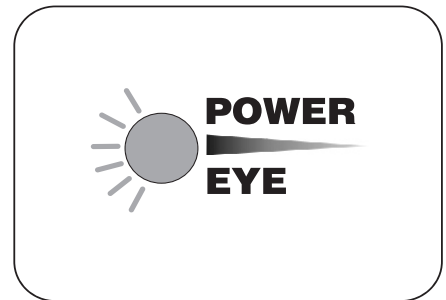

Number of Flashes	Meaning	Number of Flashes	Meaning
1	Battery needs recharging	6	Not in neutral at power up
2	Battery voltage too low	7	Speed pot error
3	Battery voltage too high	8	Motor volts error
4	Current limit time out	9	Other internal error
5	Brake fault	10	Controller over heat(C40 only)

Brakes and Throttle control lever: Whenever the speed engager lever is moved out of the neutral position, the electromagnetic brake will automatically release and your scooter will move. When the speed engager lever is released, it will return to the neutral position and the scooter will decelerate and come to a complete stop. The parking brake will then engage preventing further movement of your scooter. Your unit is equipped with a programmable controller that has a high peddle disable safety feature. This will prevent unexpected acceleration of the scooter, if the speed engage lever is activated the same time you turn the key "ON". To reset the controller, release the speed engage lever and turn the key "OFF" for a couple of seconds and then turn it back "ON".



If your scooter ever moves in an unexpected manner, release the speed engager lever and turn off the power.

■ Tiller Angle Adjustment:

At the base of the tiller is a handknob. Rotate the handknob anti-clockwise to open the joint (DO NOT FULLY UNDO THE HANDKNOB). Select the desired tiller angle and re-tighten the handknob. Ensure the tiller is fully secure before using the scooter.



■ Free Wheel Mode

Make sure the free-wheel lever is in the drive position to prevent the scooter from rolling. Never sit in your scooter if it is in "Free wheel" mode.

Manual free-wheel mode:

Your scooter features a "FREE WHEEL" mode for manual operation. To activate manually, turn the key switch OFF and locate the free-wheel lever on the right side of the rear section. Push the lever to the "FREE WHEEL" position to disengage the brake. Pull the lever to the "DRIVE" position to engage the brake. When the scooter is in manual free-wheel mode, you will have no brakes. You will be unable to operate the scooter. When you wish to push your scooter for a short distance, you may put it into Manual Free-Wheel mode.

free wheel position

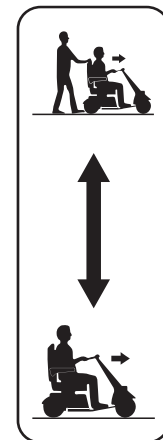

drive position

Getting ON and OFF:

Your scooter is designed to make getting on and off as easy as possible.

Make sure the scooter is on a level surface and the key switch is turned OFF. If necessary, raise the armrest to give you maximum space to transfer in or out of the seat. Once transfer is complete, return the armrest before operating the scooter.



Never operate your scooter without your feet being placed on the scooter platform. Driving your scooter without your feet on the platform could cause serious bodily injury.

S731A, S741A

■ Technical Specifications - S731A, S741A

Model No	S731A	S741A
Overall Length	39.7"	38.5"
Overall Width	20.8"	22"
Maximum Rider Weight	300 lbs	300 lbs
Batteries	2 x 12AH	2 x 12AH
Battery Pack Weight	22 lbs	22 lbs
Seat Weight	19 lbs	22 lbs
Ground Clearance	2.5"	2.5"
Total Weight	94 lbs	103 lbs
Maximum Range Up To	6 miles	6 miles
Maximum Speed	4 mph	4 mph
Front Wheel Size	8" PU Tire	7" PU Tire
Rear Wheel Size	8" PU Tire	8" PU Tire
Color	Apple red	Apple red

S731A-ARMUB







S741A-ARMUB



1	Battery Pack Ass'y 33700M71(BATTERY PACK, 12AH, BLACK)
2	Rear Shroud Ass'y 30510M51 (CANDY APPLE RED)
3	Drive Wheel Ass'y 32600565 (PU WHEEL)
4	Motor & Transmission 62009129 (TRANSAXLE ASSY)
5	Charger Unit 6510M004 (OFF BOARD HP1202-24V-1.5A 100-240V)

6	Front Shroud Ass'y 30510M57(S731A)/30510M58(S741A)
7	Front Wheel Ass'y 33100M08(S731A)/32600564(S741A)
8	Basket 43780088 (BASKET)
9	Tiller Ass'y 33510M13 ((ED) CANDY APPLE RED S731A) 33510M17 ((ED) CANDY APPLE RED S741A)
10	Seat Ass'y 32200264 (SEAT ASS' Y S731A) 32200M07 (SEAT ASS' Y S741A)

ICE SYMBOLS	
	Caution, attention or consult accompanying documents.
	Alternating Current
	Type BF Equipment
	Double Insulation
	No Smoking or Open Flames

Degree of protection against ingress of water is rated as IPx0.

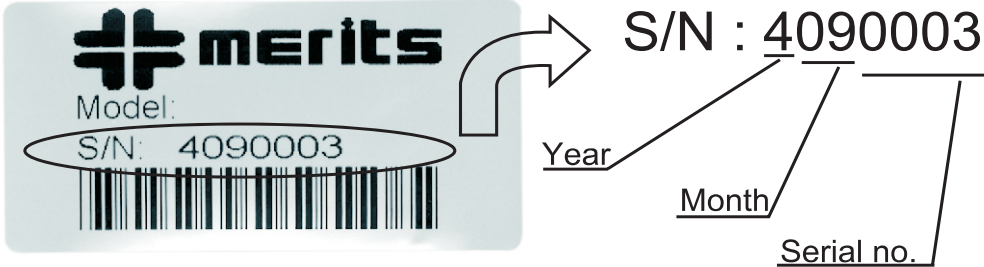
Serialization format for products	
	
1	The first digit is the last one digit of the year for manufacture.
2	The second and third digits are the month for manufacture.
3	The fourth to seventh digits are number of units manufactured during the month.

■ Merits Limited Warranty

Merits Corporation warrants to the original purchaser of this wheelchair product that it is free of defects in material and workmanship and that, when operated within the guidelines and restrictions of this manual, will remain free of defects in material and workmanship for a period of eighteen(18)moths from the original date of purchase.

Excluded from this warranty is failure due to negligence, abuse, accident, operation outside of rated limits, commercial or institutional use, damage / wear to upholstery or tires and improper maintenance or storage. The batteries for this wheelchair product are not supplied by Merits Corporation; contact the battery manufacturer / supplier if warranty replacement is requested.

This wheelchair product must not be modified in any way without the express written consent of Merits Corporation. Any such unauthorized modification could cause unreliable and / or unsafe operation and will void this warranty.

Where a failure occurs within the eighteen(18)moths warranty period that is not excluded above, the failed components will be replaced with similar new or reconditioned components at Merits sole option. Merits Corporation will not be responsible for labor and / or shipping charges.

The foregoing warranty is exclusive and in lieu of all other warranties expressed or implied including, but not limited to, the implied warranty of merchantability and fitness for a particular purpose. Merits Corporation is not liable for any consequential or incidental damages whatsoever.

S731A, S741A

■ Warranty Registration

MERITS HEALTH PRODUCTS INC. WARRANTY REGISTRATION

MODEL NO. _____

SERIAL NO. _____

DATE PURCHASED _____

NAME _____

ADDRESS _____

CITY _____ STATE _____ ZIP _____

DEALER NAME _____

STAMP

RETURN ADDRESS

MERITS HEALTH PRODUCTS INC.
730 N.E. 19th Place
CAPE CORAL, FL. 33909

We wish you a safe and comfortable riding experience!





MERITS HEALTH PRODUCTS, INC.

www.meritsusa.com 4245 EVANS AVENUE, FORT MYERS, FL 33901
TEL: 1-800-963-7487, 1-239-772-0579 FAX: 1-239-574-2661