

# MiniRider Lite



## OWNER'S MANUAL

EV Rider, LLC

6410 Arc Way, Suite A, Fort Myers, FL 33966

### Intend Use:

Moving of adult disabled persons by self driving. Maximum user weight: 130 kg;

Classified in Class A (EN12184) Maximum safe slope: 3° (Not intended for use outdoors)

**The product is not intended for visually impaired people. The drivers need to mentally and physically suitable to drive the scooters. The fingers need to work functionally. The device can't be used by children until age of 12.**

The driving distance will be reduced if the power scooter is used frequently on slopes, rough ground or to climb kerbs.

**The scooter is not for use as a seat in motor vehicle.**



All adjustments can be adjusted by both occupant and assistant

Please refer to our official website for general product information at [www.evrider.com](http://www.evrider.com)

## **⚠ WARNING**

- ◆ Don't operate your power scooter without completely reading and understanding this user manual!
- ◆ Do not operate the scooter with depleted batteries, since the occupant could be stranded.
- ◆ **The end user is NOT allowed to change the parameter.**
- ◆ **The occupant can switch off the key to stop the scooter for any emergency stop**
- ◆ **Please remove the battery package from the scooter unit before long term storage**

**MiniRider Lite should be turned off prior to entering or existing the seat. Make sure the scooter is fully un-fold before driving.**

**Please refer to our official website for general product information at [www.evrider.com](http://www.evrider.com)**

- ◆ Environmental conditions may affect the safety and performance of your power scooter. Water and extreme temperatures are the main elements that can cause damage and affect performance.

### A) Rain, Sleet and Snow

If exposed to water, your power scooter is susceptible to damage to electronic or mechanical components. Water can cause electronic malfunction or promote premature corrosion of electrical components and frame.

### B) Temperature

Some of the parts of the power scooter are susceptible to change in temperature. The controller can only operate in temperature that range between -13 F and +122 F.

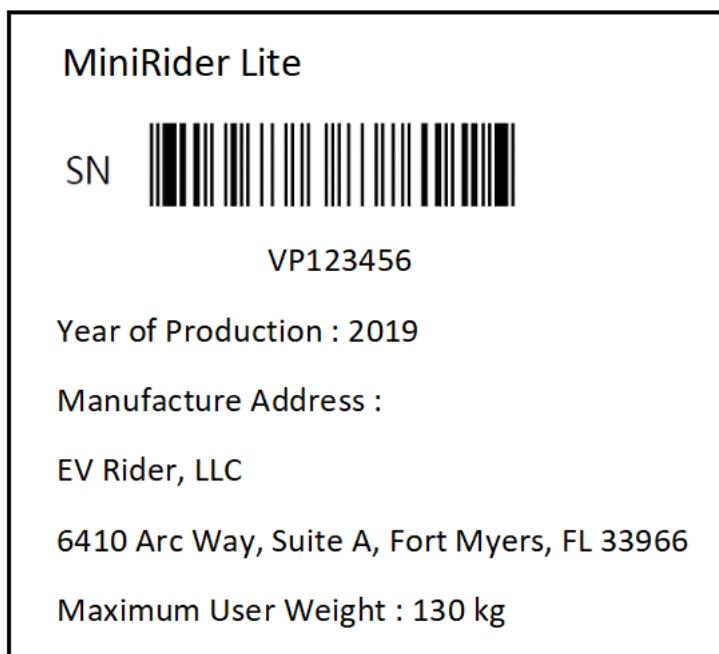

- ◆ At extreme low temperatures, the batteries may freeze, and your power scooter may not be able to operate. In extreme high temperatures, it may operate at slower speeds due to a safety feature of the controller that prevents damage to the motors and other electrical components.



# PREFACE AND INTRODUCTION

Please carefully read this owner's manual before using the vehicle. Improper use of the vehicle could result in harm, injury or traffic accidents. Therefore, for maximum pleasure while using the vehicle please read this owner's manual.

- ◆ This owner's manual includes operation instructions for every aspect of the vehicle, assembly instructions, as well as instructions for how to deal with possible accidents.
- ◆ The symbols used in this manual are explained below:  
Read especially the notes marked with these symbols:

 Warning	Improper usage could result in serious injury or death
 Attention	Improper usage could lead to injury and/or damage to your scooter.
 Suggestion	Follow these instructions to keep your vehicle in a good operating order.











- ◆ This manual includes a copy of repair and maintenance record chart and warranty information. Please keep it in a safe place or in the scooter.
- ◆ If someone else uses the scooter, please make sure that you provide them with the instruction manual for his or her consideration.
- ◆ As designs change some illustrations and pictures in the manual may not correspond to the vehicle that you purchased. We reserve the right to make design modifications.

Our scooters have been designed and manufactured to provide a comfortable and secure yet affordable solution for some mobility requirements.

## Suggestion

To maximize your batteries efficiency and service life, please fully recharge your new battery before its first time use.

# SAFETY NOTICE

 <p><b>Safety Belt</b></p> <p>Always use a seat belt, and keep your feet on the scooter all the time.</p>	 <p>Never operate the scooter while you are under the influence of alcohol.</p>	 <p>Do not ride your scooter during snow in order to avoid accident on slippery road.</p>
 <p>Never use electronic radio transmitters such as walkie-talkies, or cellular phones.</p>	 <p>Make sure that there are no obstacles behind you while reversing your scooter.</p>	 <p>Do not allow unsupervised children to play near this equipment while the batteries are charging.</p>
 <p>Do not make a sharp turn or a sudden stop while riding your scooter.</p>	 <p>Do not ride your scooter in traffic.</p>	 <p>Do not leave your hands and legs off the scooter when driving.</p>
 <p>Do not attempt to climb curbs greater than limitation show on Technical Specification</p>		

## SAFETY NOTICE

- ◆ **Warning – Don't operate your scooter for the first time without completely reading and understanding this user manual.**
- 1. Don't operate scooter on public streets and roadways. Be aware that it may be difficult for traffic to see you when you are seated on the scooter. Obey all local pedestrian traffic rules. Wait until your path is clear of traffic, and then proceed with extreme cautions. To prevent injury to yourself or others, always ensure that the power is switched off when getting on or off of the scooter.
- 2. Always check that the drive wheels are engaged (drive mode) before driving. Do not switch off the power when the scooter is still moving forward. This will bring the scooter to an extremely abrupt stop.
- 3. Do not use this product or any available optional equipment without first completely reading and understanding these instructions. If you are unable to understand the warnings, cautions or instructions, contact a healthcare professional, the dealers or technical supports before attempting to use this equipment, otherwise, injury or damage may occur.
- 4. There are certain situations, including some medical conditions, where the scooter user will need to practice operating the scooter in the presence of a trained attendant. A trained attendant can be defined as a family member or care professional especially trained in assisting a scooter user in various daily living activities. Consult with your physician if you are taking any medication that may affect your ability to operate your scooter safely.
- 5. Do not attempt to lift or move a power scooter by any of its removable parts including the armrests, seats or shrouds. Personal injury and damage to the power scooter may result.
- 6. Never try to use your scooter beyond its limitations as described in this manual.
- 7. Please do not sit on your scooter while it is in a moving vehicle.
- 8. Keep your hands away from the wheels (tires) while driving scooters. Be aware that loose fitting clothing can become caught in the drive tires.
- 9. Consult your physician if you are taking prescribed medication or if you have any certain physical limitations. Some medications and limitations may impair your ability to operate scooters in a safe manner.
- 10. Be aware when the drive mode is unlocked or locked.
- 11. Don't remove anti-tipper if there is any-tipper equipped with the scooter.
- 12. Contact with tools can cause electrical shock and do not connect an extension cord to the AC/DC converter or the battery charger.
- 13. Do not attempt to lift or move your scooter by any of its removal parts, such as the armrests, seats, or shroud.
- 14. When climbing an incline, don't drive at an angle up the face of the incline. Drive your scooter straight up the incline. This greatly reduces the possibility of a tip or a fall.
- 15. Don't climb a slope steeper than the scooter's limitation.
- 16. Don't attempt to have your scooter proceed backward down any step, curb or other obstacle. This may cause the scooter to fall or tip.

## **SAFETY NOTICE**

17. Always reduce your speed and maintain a stable center of gravity when cornering sharply. Don't corner sharply when driving scooters at higher speeds.
18. Operating in rain, snow, salt, mist conditions and on icy or slippery surfaces may have an adverse effect on the electrical system.
19. Never sit on your scooter when it is being used in connection with any type of lift or elevation product. Your scooter is not designed with such use in mind and any damage or injury incurred from such use is not the responsibility of EVRIDER.
20. Surfaces of the power scooter that can come into direct contact with the occupant's skin and/or assistant's skin during normal use and that are within occupant reach shall not exceed 106 °F. The motor surface can reach temperatures greater than 106°F after driving. Do not touch these parts when disassembling the scooter or wait until the motor is cooled down.
21. The programming of the controller shall only be carried out by personnel, which is authorized by his manufacturer. A wrong programming can result in safety hazards for the occupant!
22. If the power scooter is switched off while driving on the horizontal at maximum speed at 4 mph, it will come to a stop with the maximum stopping distance of 4 ft. Please consider this distance when driving.
23. Drive-wheel needs to be switched to engaged-mode while transporting the power scooter with a car or airplane.
24. Surface temperatures can increase when exposed to external sources of heat.
25. Surfaces of the power scooter that can come into direct contact with the occupant's skin and/or assistant's skin during normal use and that are within occupant reach shall not exceed 106 °F. The motor surface can reach temperatures greater than 106 °F after driving. Do not touch these parts when disassembling the scooter or wait until the motor is cooled down.
26. Please always turn off the power prior to entering or existing this scooter.
27. Do not operate this scoter if it is behaving abnormally or erratically.
28. Federal law restricts this device to sale by or on the order of a practitioner licensed by the law of the State in which he/she practices.

# SAFETY NOTICE

## ◆ **Modifications**

EVRIDER Product has designed and engineered power scooter to provide maximum utility. However, under no circumstances should you modify, add, remove, or disable any part or function of your power scooter. Personal injury and damage to the power scooter may result.

1. Do not modify your power scooter in any way not authorized by EVRIDER. Do not use accessories if they have not been tested or approved for EVRIDER products. Changing of controller parameter shall be only performed by authorized technicians due to the safety concern.
2. Get to know the feel of your power scooter and its capabilities. EVRIDER recommends that you perform a safety check before each use to make sure your power scooter operates safely.

## ◆ Inspections prior to using your power scooter:

1. If equipped with pneumatic tires, please check for proper tire inflations.
2. Please check all electrical connections and make sure they are tight and not corroded.
3. Please check all harness connections and make sure they are secured properly.
4. Please check the brakes.

## ◆ **Weight limitation.**

1. Please refer to the specifications table for weight capacity information. Power scooter is rated for a maximum weight capacity.
2. Stay within the specified weight capacity for your scooter. Exceeding the weight capacity voids your warranty. EVRIDER will not be held responsible for injuries or property damage resulting from failure to observe weight limitations.
3. Don't carry passengers on scooters.
4. Carrying passengers on scooter may affect the center of gravity, resulting in a tip or a fall.

## ◆ **Tire inflation**

1. If your scooter is equipped with pneumatic tires, it is necessary to check the air pressure at least one time a week.
2. Proper inflation pressures will prolong the life your tires and ensure the smooth operation while riding.
3. Do not under-inflate or over-inflate your tires. It is critically important that 30-25 psi (2-2.4bar) tire pressure be maintained in pneumatic tires at all times.
4. Inflating your tires from an unregulated air source could over-inflate them, resulting in a burs tire.

## ◆ **Temperature**

1. Some of the parts of the power scooter are susceptible to change in temperature. The controller can only operate in temperature that ranges between -13°F ~ 122°C.
2. At extreme low temperatures, the batteries may freeze, and your power scooter may not be able to operate. In extreme high temperatures, it may operate at slower speeds due to a safety feature of the controller that prevents damage to the motors and other electrical components.

# SAFETY NOTICE

## EMI

This portion of the content will provide the user with basic information that describes the problems with EMI, known sources of EMI, protective measures either to lessen the possibility or exposure or to minimize the degree of exposure, and suggested action should unexpected or erratic movement occur.

### Warning:

- ◆ The scooter itself can disturb the performance of the electromagnetic fields such as emitted by alarm systems of shops.
- ◆ The driving performance of the scooter can be influenced by electro magnetic fields

## ■ ELECTROMAGNETIC INTERFERENCE (EMI) FROM RADIO WAVE SOURCES

Powered vehicle may be susceptible to electromagnetic interference (EMI), which is interfering electromagnetic energy (EM) emitted from sources such as radio stations, TV stations, amateur radio (HAM) transmitters, two-way radios, and cellular phones. The interference (from radio wave sources) can cause the powered vehicle to release its brakes, move by itself, or move in unintended directions. It can also permanently damage the powered vehicle's control system. The intensity of the interfering EM energy can be measured in volts per meter (V/m). Each powered vehicle can resist EMI up to a certain intensity. This is called its "immunity level". The higher the immunity level, the greater the protection. At this time, current technology is capable of achieving at least a 20 V/m immunity level, which would provide useful protection from the more common sources of radiated EMI. This powered vehicle model as shipped, with no further modification, has an immunity level of 20 V/m without any accessories.

There are a number of sources of relatively intense electromagnetic fields in the everyday environment. Some of these sources are obvious and easy to avoid. Others are not apparent and exposure is unavoidable. However, we believe that by following the warning listed below, your risk to EMI will be minimized.

The sources of radiated EMI can be broadly classified into three types:

1. Hand-held portable transceivers ( transmitter-receivers with the antenna mounted directly on the transmitting unit. Examples include: citizens band (CB) radios, " walkie talkie", security, fire, and police transceivers, cellular telephones and other personal communication devices.
2. Medium-range mobile transceivers, such as those used in police cars, fire trucks, ambulances and taxis. These usually have the antenna mounted on the outside of the Vehicle,
3. Long-range transmitters and transceivers, such as commercial broadcast transmitter (radio and TV broadcast antenna towers) and amateur (HAM) radios;



# PARTS INTRODUCTION

## PARTS DESCRIPTION

- |                        |                                   |                      |
|------------------------|-----------------------------------|----------------------|
| 1. Power switch        | 2. Charger Socket Cover           | 3. Basket Bracket    |
| 4. Tiller Adjust Lever | 5. Wheel lock knob                | 6. Seat Rotate Lever |
| 7. Armrest             | 8. Width Adjustable Armrests Knob |                      |
| 9. Circuit Breaker     | 10. Freewheel Lever               |                      |
| 11. Anti-tip Wheel     | 12. Connecting device             |                      |



# OPERATION

## CONTROL PANEL

1. Battery Level Indicator
2. Speed Dial
3. Horn
4. Wigwag Paddle



## HOW TO OPERATE YOUR SCOOTER

### ■ Power switch

Turn the key to power ON or OFF

(ON) : Power is turned on

(OFF) : Power is turned off



### ■ Speed Dial

Press the slowest or fastest setting to determine the maximum speed of the scooter.



Slowest setting

Fastest setting

### ■ Forward, Reverse, and Braking

- ◆ Pull the speed control lever backwards with your right fingers and the vehicle will move forward.
- ◆ Pull the speed control lever backwards with your left fingers and the vehicle will move backward.
- ◆ The horn will beep when the vehicle is in reverse.
- ◆ Release the speed control lever freely while either going forward or reverse, and the electromagnetic brake in the motor will be activated, and the vehicle will stop.

# OPERATION

## ■ Horn Button

Press the horn button to sound the horn. Release the button to stop the horn.

## ■ How To Set Freewheel Mode

The motor on the scooter can be disengaged to allow the scooter to be pushed.

- ◆ Drive Mode
  - To put the scooter in to “drive” mode, push the freewheel lever up completely
- ◆ Freewheel Mode
  - To put the scooter in to “freewheel mode”, push the freewheel lever down completely and the scooter can be moved manually.
- ◆ Please note that this will put the scooter in to freewheel mode, so scooter’s motor and brake will be disengaged

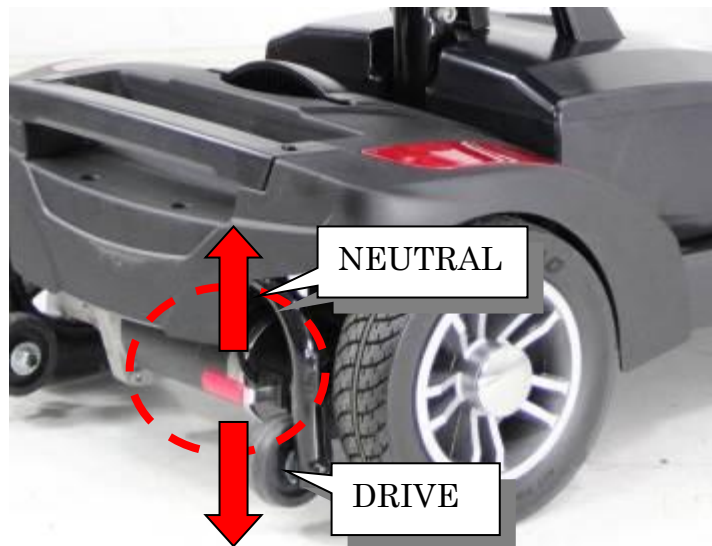

## ■ Battery Indicator

The battery indicator on the tiller console uses a color code to indicate the approximate power remaining in your batteries. Green indicates (40~100%) capacity, yellow a draining charge(10 ~ 30%),and red indicates that an immediate recharge is necessary.

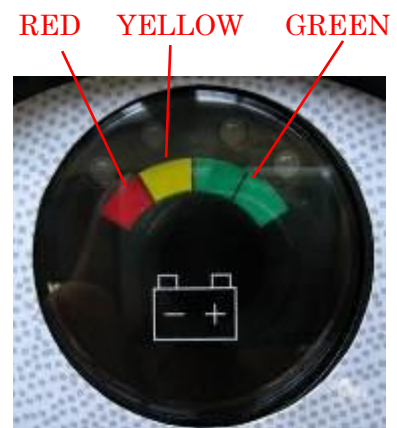

- ◆ The remaining power suggested by the battery indicator will vary by the actual driving time incurred and how you drive. Repeated starting, stopping, climbing will consume the power more quickly.

# OPERATION

## ■ Braking

- ◆ Electro-magnetic brake:  
Release the speed control lever completely, and the electromagnetic brake will be activated automatically, and the scooter will stop.
- ◆ Manual hand brake (if fitted with this option):  
Emergency braking is possible using the manual hand brake. Squeeze the hand brake and use the button to lock it (use it for parking).
- ◆ Squeeze the hand brake again to release the button.

## ■ Parking

- ◆ After stopping, turn the main key to OFF and remove the key. The lights will turn OFF. The electromagnetic brake is engaged (locked).
- ◆ The hand brake lever can be locked by pushing button while squeezing hand brake lever. To release the hand brake – squeeze lever gently.

### ⚠ Warning

When on a gradient NEVER switch the vehicle to the freewheel mode. The electromagnetic brakes will not be applied. This may result in injury.

## ■ How to adjust the armrest width

Loosen the knobs at the back of the seat frame firstly, then adjust the armrest width by sliding the armrest. Once satisfied with the width, tighten the knob.



## ■ Seat

- ◆ The seat can be turned to 45 degrees or 90 degrees.
- ◆ Pull the seat adjustment lever forward and swivel seat.
- ◆ Release the lever, then continue swiveling the seat until it locks in position.

### ☞ Attention

- ◆ Return the seat to the forward position before driving.
- ◆ Ensure the limit switch is set to the slowest setting when using the scooter on the pavement. It is an offence to travel faster than 4mph on the pavement.

# OPERATION

### ■ How to re-position the seat

The seat can be slide backward and forward for a comfortable driving position. To slide the seat, pull the lever at the front the seat and reposition as required.



### ■ Tiller Adjustment

The tiller can be adjusted in to many different positions to suit each driver.

1. Loosen the lever to adjust the tiller to positions you want.
2. Once decide the position, tighten the lever to secure the tiller.



### ■ Main Circuit Breaker (Reset Button)

When the voltage in your scooter's batteries becomes low or the scooter is heavily strained because of excessive loads or steep inclines, the main circuit breaker may tip to protect the motor and electronics from damage.



## ASSEMBLING AND DISASSEMBLING

### ■ Assembling The Scooter

No tools are required to disassemble or assemble your scooter.

1. Place the freewheel mode lever in the drive position.
2. Set the rear section in the up position and make sure the hook for the front section is connected to the axle of the rear section.
3. Put down the front and rear sections until the scooter is lock.
4. Set down the battery pack on the scooter, and make sure it is in the correct position.
5. Set down the seat on the seat post until the swivel lock engages and you hear a click.
6. Turn key switch to “ON”. Make sure battery gauge indicates sufficient power.

### ■ Disassembling The Scooter

The **T4D** can be disassembled in to four pieces, the seat(7.21 kg / 15.9 lbs), the front section (15.74 kg / 34.7 lbs),the rear section (10.69 kg / 23.5 lbs) and battery pack (9.18 kg / 20.2 lbs).

#### ⚠ Warning

To avoid personal injury, ask for assistance, if necessary, while disassembling or assembling your scooter.



Please follow the steps.

1. Make sure the tiller is raised before reassembling the scooter.
2. Turn key switch to “OFF”.
3. Place the free wheel mode lever in the drive position.
4. Take off the basket.
5. Push the Seat Rotate Lever whilst pulling up on the seat to remove.
6. Unlock the battery lock part and rotate the battery lock part.
7. Pick up the battery pack and remove it from the scooter.
8. Loosen the tiller adjustment knob and fold down the tiller and retighten knob.
9. Lock the front wheel and tiller by turn and pull the wheel lock catch down.
10. Pull the connecting device upward to the rear section and stand upright.
11. Take off the front section with both hands and lower the shaft.

## OPERATION





5. Push the Seat Rotate Lever whilst pulling up on the seat to remove.

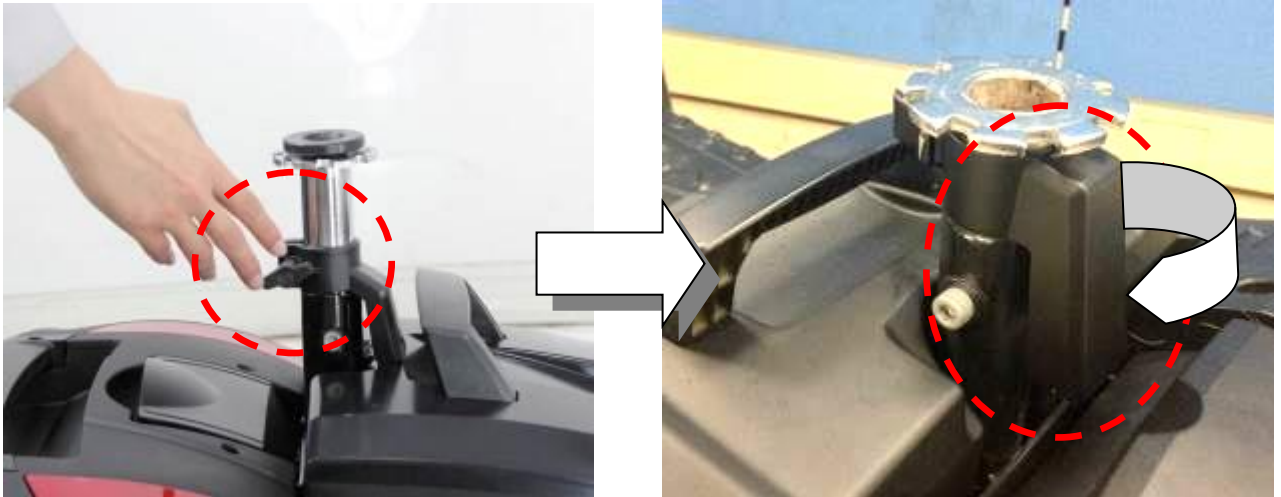

6. Unlock the battery lock part and rotate the battery lock part.



7. Pick up the battery pack and remove it from the scooter.

## OPERATION



8. Loosen the tiller adjustment knob and fold down the tiller and retighten knob.

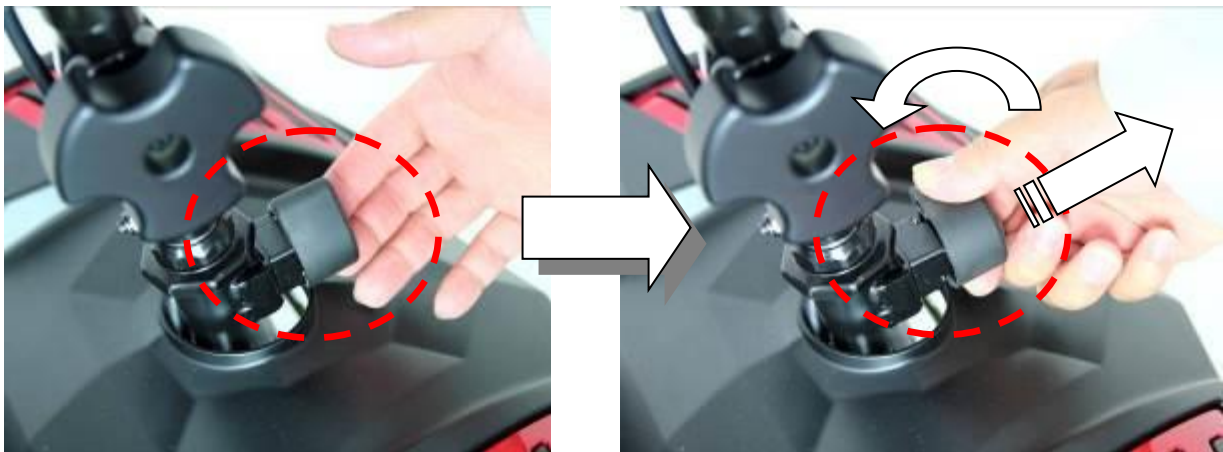

9. Lock the front wheel and tiller by turn and pull the wheel lock catch down.

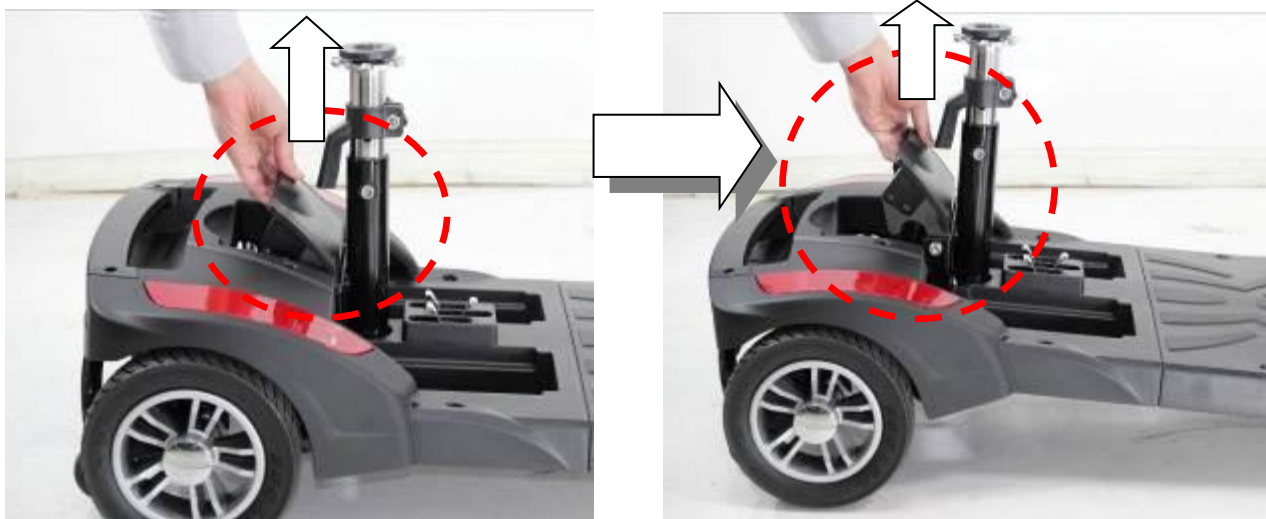

10. Pull the connecting device upward to the rear section and stand upright.



# OPERATION

## CHANGING THE OPTIONAL COLOR PANEL

Your scooter features interchangeable panels which allow you to change the color of your scooter.

These instructions will guide you through the process of changing the panels. The panels that can be changed are indicated in the illustration at the right.



### ■ To replace the tiller color panel

Use a screwdriver to unlock tiller colour panel.



### ■ Replacing the front and rear shroud color panel

Please disassemble the scooter before you replace the front and rear shroud color panel.

Remove the color panel by snapping off from underneath the shroud, screwdriver is required.



# BATTERY CHARGING AND CARE

## CHARGING THE BATTERY

Follow the procedure below step by step:

1. Turn the power switch to (OFF)
2. Connect the charger's power cord into the power outlet.
3. Open the charging socket cap on the battery pack. Then connect the charger's round plug to the charging socket.
4. Turn on the switch on the charger.
5. Both the charger's red and orange LEDs will be lit when beginning charging. The charging duration is about 6 hours. To ensure optimum performance a 10-hour charge is recommended. But we do not recommend a charging more than 24 consecutive hours.
6. Both the charger's LEDs will be lit during the charging process. The orange LED will turn green when charging is complete.
7. Turn off the charger; disconnect the power cord and the round plug from charger socket on the scooter.



### **⚠ Warning**

- ◆ The fan inside the charger will be activated accordingly when you turn on the charger. If the fan does not work when connected to the charger or the green light is not showing, DO NOT use this charger. It may lead to overheating of the charger and cause a fire as a result.
- ◆ There is a red LED present on the charger to illustrate operation. If this LED does not illuminate the charger is defective, please contact your dealer.

### **👉 Attention**

- ◆ While gripping or folding the handle bar, beware of finger or hands caught in the handle area.
- ◆ While returning the battery pack to the battery pack cavity of shroud, beware of finger or hands.

### **⚠ Warning**

1. Keep away from flammable objects while charging as it may lead to fire or explosion of battery.
2. Do not smoke while charging as the battery may release hydrogen gas. Always charge your battery in a well-ventilated space.
3. Never connect or disconnect the plug or cord with wet hands while charging. Do not connect or disconnect the plug or cord when they are wet, it may lead to electric shock.

*NOTE: The immovable function will be activated while your scooter is in charging status, which will make your scooter not run.*

# BATTERY CHARGING AND CARE

## **Attention - Please follow the rules below to avoid accidents while charging.**

1. Please use the WU'S charger only, and recharge the battery to its full capacity every time. You may damage the battery and scooter if you use a charger, which is not to the correct specification.
2. Please charge in a well-ventilated space where it is not directly exposed to the sunlight. Do not charge in surroundings where it is humid or under rainfall and morning dews.
3. Do not charge in temperatures less than  $-10^{\circ}$  C or higher than  $+50^{\circ}$ C as the charger may not work well and the batteries may become damaged.

## **BATTERY**

- ◆ Do not expose the battery to temperatures below  $14^{\circ}$  F or above  $122^{\circ}$  F when charging or storing the vehicle. Under the above temperature range can cause the battery either to freeze or overheat. This will damage the batteries and shorten their life.
- ◆ These batteries are maintenance free and there is no need to refill with water.
- ◆ You are required to recharge the batteries on a regular basis. Even if the scooter is stood idle, you should charge the batteries at least once a week.
- ◆ The batteries carry a six-month manufacturer's warranty. This warranty only covers issues relating to manufacturing faults, and not faults relating to failure to recharge the batteries as instructed above.

## **Suggestion – How to maximize your batteries efficiency and service life**

1. Fully recharge your new battery before it's first time use.
2. Be sure to charge the battery fully every time. The battery life will be seriously shortened or decayed if the battery is repeatedly used without being fully charged.
3. Always complete the charging until the orange LED light turns green. NEVER stop charging before it is complete.
4. Keep your batteries fully charged whenever possible.
5. If you do not use your scooter for a long time, it should be charged at least every week to keep the battery in a fully usable condition.
6. The ambient temperature will affect charging time. Charging time will be longer in the winter.
7. After charging, do not leave the charger socket plugged in to the scooter, as this will cause a power drain on the scooter and temporarily reduce its range.

# BATTERY CHARGING AND CARE

## ■ Cleaning the battery

If the batteries are contaminated by water, battery acid, dust or other substances, they will discharge quickly. The batteries supplied with the WU'S scooter are sealed and as such are maintenance free with no risk of battery leakage. Please follow the steps below to clean the battery.

1. Turn the scooter power switch to "OFF".
2. Remove the seat and dust cover.
3. Remove the shroud and unplug the terminal of the taillight and signal lights.
4. Use a clean cloth to wipe off the soiled area.
5. Take out the battery.
6. Clean the battery with a clean cloth. If the terminal is covered by white powder, please wipe it clean using warm water.

## ⚠ Warning

1. The wiring system and charger are well situated in battery pack while assembled in plant. Do not attempt to re-locate the wiring system by yourself. The improper layout of wiring system may result in the wires pinched by battery box, which might the electronic system failure.
2. Be sure the battery wires are connected to their right battery terminal.

## 📖 Suggestions

If necessary, ask for help from your dealer for advice about maintaining and replacing the battery.

## 📖 Suggestions

1. Make sure the terminals are installed properly and put the cover back on.
2. Do not use the battery to charge telecom equipment or other items.
3. Battery efficiency will vary with outside conditions; the driving distances will be shorter in the winter. If the vehicle is not used for a long time, please charge the battery at least every week.
4. Replace both batteries together.
5. For best results, use sealed type batteries.
6. Install only new batteries of the same type in your product.
7. Failure to insert batteries in the correct polarity, as indicated in the battery compartment, may shorten the life of the batteries or cause batteries to leak.
8. Do not mix old and new batteries.
9. Do not mix Alkaline, Standard (Carbon-Zinc) or Rechargeable (Nickel Cadmium) or (Nickel Metal Hydride) batteries.
10. Danger of explosion if battery is incorrectly replaced.
11. Batteries should be recycled or disposed of as per state and local guidelines.



# INSPECTION AND MAINTENANCE

## INSPECTION

- ◆ Clean the scooter with a damp cloth and dust down approximately once a week to preserve the appearance of the scooter.
- ◆ Adjust the tiller height and return to the original position and swivel the seat once a week to ensure the parts adjust and remove smoothly and easily when required.
- ◆ Check for signs of wear and tear on the tires and the upholstery on a regular basis.
- ◆ For optimum performance and to increase the lifespan of your scooter, it is recommended that you have your scooter serviced once a year.

## REGULAR CHECKING RECORD

To make sure your scooter is correctly serviced, take it to your dealer for regular maintenance checks. This should be at intervals of six months after the first inspection after one month. Your dealer may charge a fee for this service.

YEAR	1	2	3	4	YEAR	1	2	3	4
Service Dates					Service Dates				
Controller					Upholstery				
On/off switch					Seat				
Controller Lever					Back				
Braking					Armrests				
Recharge point					Electrics				
Batteries					Connections				
Levels					condition				
Connections					Lights				
Discharge test					Test run				
Wheels and Tyres					Forwards				
Wear					Reverse				
Pressure					Emergency stop				
Bearings					Left turn				
Wheel nuts					Right turn				
Motors					Slope test				
Wiring					Over obstacles				
Noise					List Items repaired				
Connections									
Brake									
Brushes									
Chassis									
Condition									
Steering									

## BATTERY, FUSE AND TYRE

### ■ Battery

Refer to the section entitled “ 5.2 BATTERY” in “5. BATTERY CHARGING AND CARE ”.

### ■ Fuse

If the battery charger is turned on and no LEDs are lit, check the fuse.

# INSPECTION AND MAINTENANCE

## Suggestion

Ask for help from your scooter dealer to inspect or replace the fuse, since the tiller shroud has to be removed first before you can replace the fuse.

## ■ Tires

The condition of the tires depends on how you drive and use your scooter.

- ◆ Inspecting tire tread
- ◆ Please check the tread groove regularly. Replace the tires when the tread groove is less than 0.5 mm.

## Attention

- 1 . When tread groove is below 0.2 in it can easily lead to vehicle slippage, making braking distances longer. Therefore, replace the tires as early as possible when they do not have insufficient tread depth.

## Attention

When conducting maintenance of your vehicle, please turn the power switch to OFF and remove the charger cords.

## Suggestions

- ◆ Do not splash water directly to wash your scooter as this could lead to malfunction of the system electrics.
- ◆ Do not use petrol, solvents or vaporizing solution as these may deform or damage the shrouds.
- ◆ Do not use wax.

# INSPECTION AND MAINTENANCE

## STORAGE

Make sure the vehicle is stored under the following circumstances:

- ◆ Make sure the seat is set in the “Forward” position
- ◆ Make sure the Power switch is turned to OFF
- ◆ Your power scooter should be stored in a dry place, free from temperature extremes. When storing, disconnect the batteries from the power scooter. If you fail to store the unit properly, the frame can rust and the electronics can be damaged.
- ◆ Please remove the battery package from the scooter unit before long term storage

If you plan on not using your power scooter for an extended period of time, it is best to:

- ◆ Fully charge its batteries prior to storage.
- ◆ Disconnect the batteries from the scooter.
- ◆ Store your power scooter in a warm, dry environment.
- ◆ Avoid storing your power scooter where it will be exposed to temperature extremes.
- ◆ Operating conditions (-13 F ~ 122 F) and Storage conditions (-40. F~149 F)
- ◆ Make sure the batteries are fully charged before use after long-term storage

Batteries that are regularly and deeply discharged, infrequently charged, stored in extreme temperatures, or stored without a full charge may be permanently damaged, causing unreliable performance and limited service life. It is recommended that you charge the power scooter batteries periodically throughout periods of prolonged storage to ensure proper performance.

## MOVING ABOUT

- ◆ Turn the power switch “OFF” before moving.
- ◆ Lift the scooter by the chassis, and not by the bumpers. Lifting the scooters by the bumper could cause damage or injury.
- ◆ For your safety, always ask for help if required. You will need 2 or 3 persons when moving or lifting the vehicle.

# TROUBLE SHOOTING AND SPECIFICATION

## ■ TROUBLE SHOOTING

<i>Symptom</i>	<i>Remedy</i>
The scooter will not switch on	<ul style="list-style-type: none"> <li>• Try recharging the battery</li> <li>• Check the fuse and circuit breaker in the scooter</li> </ul>
The scooter switches on, but the scooter will not move.	<ul style="list-style-type: none"> <li>• Ensure there is enough power in the batteries. If not, recharge the batteries.</li> <li>• Ensure the freewheel lever is engaged in the 'DRIVE' position.</li> </ul>
The scooter appears slow	<ul style="list-style-type: none"> <li>• Check the battery power level and recharge</li> <li>• Check the speed dial is not set to slow.</li> </ul>
The seat turns when in operation	<ul style="list-style-type: none"> <li>• Slowly rotate the seat until it drops in to place and is secure</li> </ul>
The handlebar appears loose	<ul style="list-style-type: none"> <li>• Tighten the height adjustment handle to secure the handlebar</li> </ul>
Involuntarily horn sounds	<ul style="list-style-type: none"> <li>• Ensure that the wigwag paddle is released.</li> <li>• Switch the scooter off and on.</li> <li>• Recharge the batteries.</li> <li>• If the problem persists, contact your WU'S dealer.</li> </ul>



# TROUBLE SHOOTING AND FLASH CODES

## ■ FLASH CODES

- ◆ Your power wheelchair is fitted with DYNAMIC controller, which continuously monitors the operating conditions of your power wheelchair. If it detects a problem, it will indicate with error message by flashing light on the power ON/ OFF light. You must count the number of the flash, and see the list to check what kind of error has happened according to the number)
- ◆ If, when powered up, there is an error with the system, then the status indicator will flash red. The number of flashes will indicate the type of error. These are described in the table below.

Flash*	Description	Meaning
1	Battery Low	The batteries are running low or are in an over-discharged state. <ul style="list-style-type: none"> <li>• Recharge the batteries.</li> </ul>
2	Low Battery Fault	The batteries have run out of charge. <ul style="list-style-type: none"> <li>• Recharge the batteries.</li> <li>• Check the battery and associated connections and wiring.</li> </ul>
3	High Battery Fault	Battery voltage is too high. This may occur if overcharged &/or travelling down a long slope. <ul style="list-style-type: none"> <li>• If travelling down a slope, reduce your speed to minimise the amount of regenerative charging.</li> </ul>
4	Current Limit Time-out or Controller too hot	The motor has been exceeding its maximum current rating for too long. <ul style="list-style-type: none"> <li>• The scooter may have stalled. Turn the controller off, leave for a few minutes and turn back on again.</li> <li>• The motor may be faulty. Check the motor and associated connections and wiring.</li> </ul>
5	Park Brake Fault	Either a park brake release switch is active or the park brake is faulty. <ul style="list-style-type: none"> <li>• Check the park brake and associated connections and wiring.</li> <li>• Ensure any associated switches are in their correct positions.</li> </ul>
6	Drive Inhibit	Either a Stop function is active or a Charger Inhibit or OONAPU condition has occurred. <ul style="list-style-type: none"> <li>• Release the Stop condition (seat raised etc.)</li> <li>• Disconnect the Battery Charger</li> <li>• Ensure the throttle is in neutral when turning the controller on.</li> <li>• The Throttle may require re-calibration.</li> </ul>
7	Speed Pot Fault	The throttle, speed limit pot, SRW or their associated wiring may be faulty. <ul style="list-style-type: none"> <li>• Check the throttle and speed pot and associated connections and wiring.</li> </ul>
8	Motor Voltage Fault	The motor or its associated wiring is faulty. <ul style="list-style-type: none"> <li>• Check the motor and associated connections and wiring.</li> </ul>
9	Other error	The controller may have an internal fault. <ul style="list-style-type: none"> <li>• Check all connections and wiring.</li> </ul>

\* The Scooter and R-Series produce the same flash code sequences to indicate a fault, but the flash timings are different:

# SPECIFICATION

## ■ SPECIFICATION

Model Reference	<b>T4D</b>
Dimension (L x W x H mm/in)	1080 x 480 x 910 mm / 42.5 x 19 x 36in
Weight w/i battery without battery	42.8 kg / 92 lb.
	33.6 kg / 72.2 lbs
Battery	12 Ah(option 20Ah)
Charger	2A Off-Board
Front Tire	200X50 PU TIRE
Rear Tire	200X50 PU TIRE
Driving System	Direct drive the rear wheels (with differential gear)
Brake System	Electromagnetic brakes
Control Method	By speed control lever
Top Speed	4 mph / 6.4 Km/h
Climbing angle	8 degree
Cruising range	6 ~ 7.5 miles /10 ~ 12 km
Max. user weight	130 kg (280 lb.)

- ◆ MiniRider Lite seat is tested according to EN 1021 regarding resistance to ignition, but it is recommended to avoid the use of flame near the power scooter and of smoking during sitting on the power scooter.
- ◆ The stability tests were performed in the least stable positions of the seat (height and front/rear position).
- ◆ The distance will be reduced if the wheelchair is used frequently on slopes, rough round or to climb the curbs.
- ◆

### **WARNING**

The stopping distance on the slope can be significantly greater than on the level ground.

# SPECIFICATION

## ■ ISO 7176-5 TEST RESULTS

Test items	Test results
4.1 Overall dimensions- Dimensions of scooter ready for occupation	
(I) Overall length	1080 mm
(II) Overall width	480 mm
(III) Overall height with backrest in the upright position	910 mm
(IV) Stowage height (Armrest)	530 mm
4.2 Total weight included battery (12AH)	46 kg
Mass of heaviest part (The front frame)	18 kg
4.3 Turning space	
(I) Minimum turning radius	1400 mm
(II) Turn-around width between limiting walls	1520 mm
4.4 Ground clearance	
(I) Transaxle	33 mm
(II) Others (Frame)	38 mm
(III) Anti-tip wheel	15 mm

# BATTERY SPECIFICATIONS

## WP12-12 12Volt 12Ah

### Specifications

Nominal Voltage(V) **12V**

#### Nominal Capacity

20 hour rate	(0.6A to 10.50V)	<b>12Ah</b>
10 hour rate	(1.14A to 10.50V)	<b>11.4Ah</b>
5 hour rate	(2.04A to 10.20V)	<b>10.2Ah</b>
1 C	(12A to 9.60V)	<b>6.8Ah</b>
3 C	(36A to 9.60V)	<b>4.8Ah</b>

Weight **Approx. 4.1kg(9.02Lbs.)**

Internal Resistance (at 1KHz) **Approx. 13 mΩ**

#### Maximum Discharge Current for

5 seconds: **180A**

#### Charging Methods at 25°C (77°F)

##### Cycle use:

Charging Voltage **14.4 to 15.0V**

Coefficient **-5.0mV/°C/cell**

Maximum Charging Current : **3.6A**

##### Standby use:

Float Charging Voltage **13.5 to 13.8V**

Coefficient **-3.0mV/°C/cell**

#### Operating Temperature Range

Charge **-15°C (5°F) to 40°C (104°F)**

Discharge **-15°C (5°F) to 50°C (122°F)**

Storage **-15°C (5°F) to 40°C (104°F)**

#### Charge Retention (shelf life) at 20°C (68°F)

1 month **92%**

3 month **90%**

6 month **80%**

#### Case Material

**ABS**

(Option: UL94 HB & UL94 V-0 flame retardant )

#### Terminal

**F1 or F2 (Faston Tab 187 or 250)**



### Dimensions

mm(inch)



F1  
(Faston Tab 187)

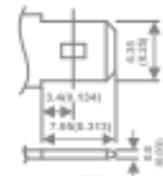

F2  
(Faston Tab 250)

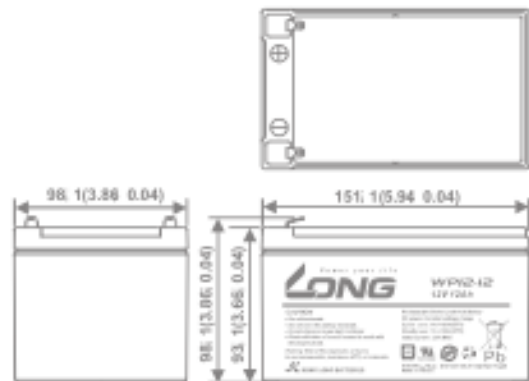

12V FOR 12V BATTERIES

Discharge Time VS. Discharge Current (25°C)

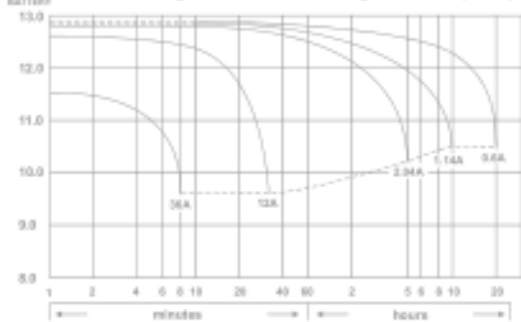

Discharge Time

010213-1E



## Warranty by EV Rider, LLC

### All Products – Except the Stand-N-Ride

#### **THREE-YEAR LIMITED WARRANTY**

Three (3) years from the date of purchase on all structural frame components; including platform, seat post, and frame.

#### **ONE-YEAR LIMITED WARRANTY**

One (1) year from the date of purchase, if any part or electronic component of the Scooter is found upon examination to be defective in material and/or workmanship, it will be repaired or replaced, at EV Rider, LLC's option, without charge.

**Labor charges are NOT included.** The purchaser is responsible for the delivery to the authorized repair facility. Satisfactory proof of purchase, serial number and the date of purchase are always required. For warranty service, please contact the dealer/company from whom you purchased your EV Rider product.

**SHIPPING - DOMESTIC:** All warranty items will be shipped via Fedex Ground. Requested expedited shipping will be at the expense of the purchaser.

**SHIPPING - INTERNATIONAL:** Parts will be provided under warranty at no charge, but shipping to any offshore and/or international location will be the responsibility of the purchaser. International and offshore end-users must contact the dealer/distributor directly to initiate the warranty process.

#### **ONE-YEAR WARRANTY EXCEPTIONS**

**Motor:** In cases where there is an increase in the operational noise level, the warranty does not apply. (An increase in operational noise level usually occurs due to abusive and excessive strain on the scooter).

The batteries that are purchased separately or in addition to the batteries provided with the scooter are warranted by EV Rider for one year after the purchase of the Unit with the exception of the Stand-N-Ride scooter.

**Service:** Warranty service can be performed by EV Rider, LLC or by an authorized EV Rider, LLC service facility. **Do not return faulty parts to EV Rider, LLC without prior consent.** A request for a Return Authorization is required prior to returning items. All transportation costs and shipping damage incurred while submitting units and/or parts for repair or replacement are the responsibility of the original purchaser.

**WARRANTY EXCLUSIONS:** This warranty is only given to the original purchaser of the Scooter. This Warranty excludes:

- Batteries that are provided free with the scooter. See the EV Rider invoice/packing slip for additional detail.
- Consumable items which may need replacing due to normal wear and tear (tires, tubes, belts, bulbs, upholstery and seating, motor brushes, fuses, plastic shrouds and footrest covers, etc.)
- Damaged caused by: battery fluid spillage or leakage, abuse, misuse, accident, or negligence, improper operation, excessive loading, maintenance, or storage, commercial use or use other than normal.
- Used other than for the purpose of the purchaser's mobility.
- Repairs and/or modifications made to any part of the scooter without specific and prior consent from EV Rider, LLC.
- Labor, service calls, shipping, and other charges incurred for repair of the product not approved by EV Rider, LLC.

**Batteries:** Batteries carry a limited warranty which is subject to a stringent wear and tear clause. Any battery faults due to a defect in the original manufacture will normally become obvious within the first two months of use. Any gradual deterioration in performance after this period is normally associated with fair wear and tear, misuse or accidental damage and as such is not covered by the manufacturer's warranty. There is no other express warranty.

Implied warranties, including those of merchantability and fitness for a particular purpose, are limited to one (1) year from the date of the original purchase and to the extent permitted by law. Any and all implied warranties are excluded. This is the exclusive remedy. Liabilities for consequential damages under any and all warranties are excluded.

Some states do not allow limitations on how long an implied warranty lasts or do not allow the exclusion of limitation of incidental or consequential damages. So, the above limitation or exclusion may not apply to you.

**EV Rider, LLC // [www.evrider.com](http://www.evrider.com)**

**800-944-1997**

# BOM LIST DRAWING

1	FRAME, FRONT
2	FRAME, REAR
3	SHROUD
4	COVER, HAND BAR ASS'Y
5	BATTERY PACK ASS'Y
6	TILLER
7	TIRE
8	SEAT
9	ELECTRONIC ASS'Y
10	SPEED DIAL ASS'Y
11	ACCESSORIES

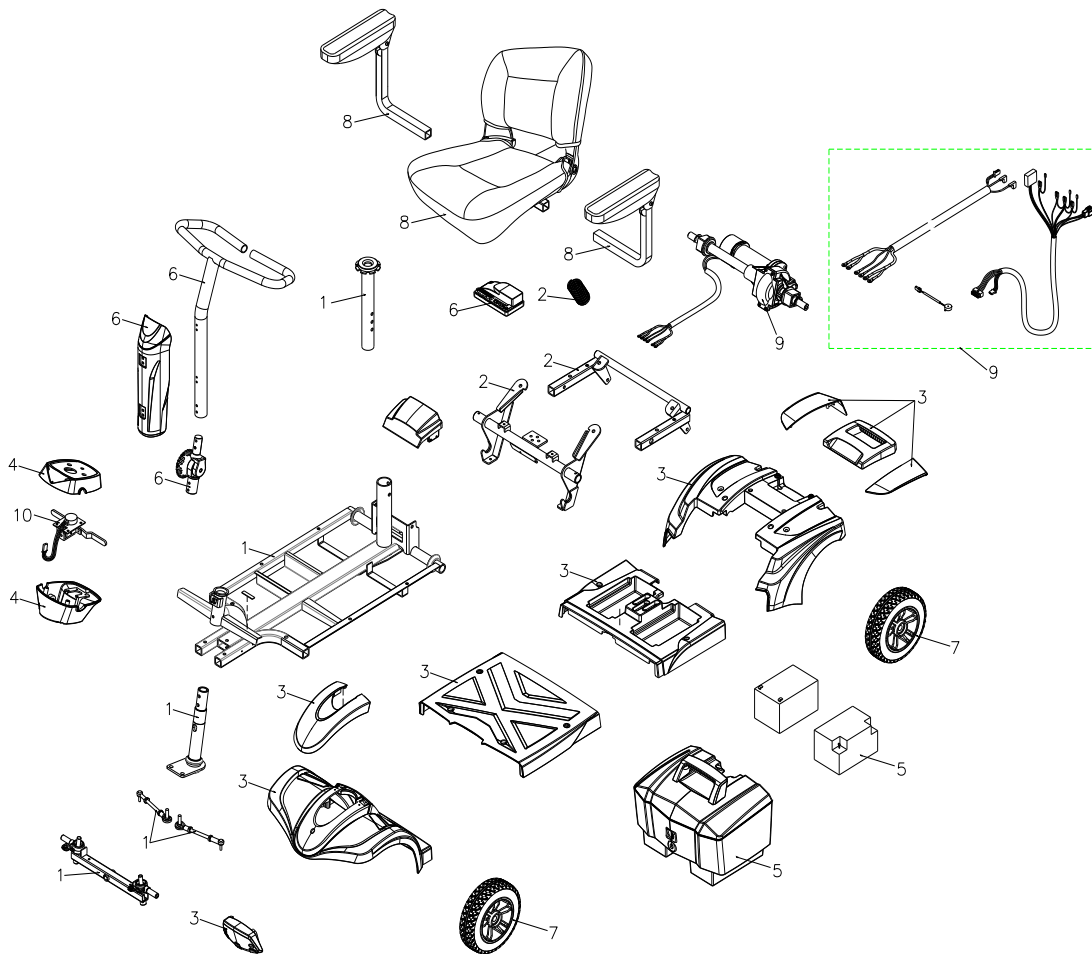

Designed and manufactured by:



**Wu's Tech Co. Ltd.**

**3 Fl. No.112 Sec. 2, Chung-Shan N. Rd.,  
Taipei, Taiwan, R.O.C.  
Tel: +886 2 2541 3253  
Fax:+886 2 2536 7575**

**Distributed by:**



**EV Rider, LLC**  
**6410 Arc Way**  
**Fort Myers, FL 33966**  
**Tel: (239) 278-5054**  
**Fax: (239) 278-1431**  
**[service@evrider.com](mailto:service@evrider.com)**  
**[sales@evrider.com](mailto:sales@evrider.com)**