

# LVP919 Series

## LED VIDEO WALL PROCESSOR

### USER MANUAL V1.1



# Contents

<b>Chapter 1: Safety precautions.....</b>	<b>3</b>
<b>Chapter 2: Packing list.....</b>	<b>4</b>
<b>Chapter 3: Hardware Connection.....</b>	<b>5</b>
3.1 Diagram of signal ports on rear panel.....	5
3.2 Ports description.....	5
3.3 Hardware connection diagram.....	7
3.4 Technical specification.....	8
<b>Chapter 4: Description for front panel buttons.....</b>	<b>11</b>
4.1 Sketch map of front panel buttons.....	11
<b>Chapter 5: Instructions of basic operations for users.....</b>	<b>13</b>
5.1 Selection from input signals.....	13
5.2 Operations on PIP mode.....	16
5.3 Call mosaic application mode.....	17
5.4 Other basic operations.....	17
<b>Chapter 6: User Setup Menu Instructions.....</b>	<b>20</b>
6.1 Output image.....	21
6.2 PIP.....	25
6.3 Input signal setting.....	26
6.4 Image quality setting.....	27
6.5 Communication setting.....	28
6.6 Language setting.....	29
6.7 Audio setting.....	29
6.8 Advanced setting.....	30
<b>Chapter 7: Module description.....</b>	<b>32</b>
Appendix: correction log table.....	33

## Chapter 1: Safety precautions



### Danger

There exists high voltage in the processor, in order to prevent any unexpected hazard, please do not open the cover of the device unless you are a maintenance.



### Warning

1. This device shall not encounter water sprinkle or splash, please do not place anything containing water on this device;
2. Keep this device away from any fire source to prevent fire;
3. If this device gives out any strange noise, smoke or smell, please unplug the power cord from receptacle immediately, and contract local dealer;

**4. Signal cables are hot swappable.**



### Caution









1. Please thoroughly read this manual before using this device, and keep it safe.
2. In the event of lighting or when you are not going to use the device for a long time, please pull the power plug out of receptacle.
3. Nobody other than professional technicians can operate the device, unless they have been appropriately trained or under guidance of technicians.
4. To prevent equipment damage or electric shock, please don't fill in anything in the vent of the device.
5. Do not place the device near any water source or anywhere damp.
6. Do not place the device near any radiator or anywhere under high temperature.
7. To prevent rupture or damage of power cords, please handle and keep them properly.
8. Please immediately unplug power cord and have the device repaired, when
  - ① Liquid splashes to the device.
  - ② The device is dropped down or cabinet is damaged.
  - ③ Obvious malpractice is found or performance degrades.

## Chapter 2: Packing list

Please unpack the product carefully, then check whether all the following things are included in the package. If anything is missing, please contact the dealer.

### Standard accessories

The accessories supplied with this LED Video Processor may differ from the figures on the User's Manual, but they are applicable for the regions where you live.(LED sending card is optional)

		
1.5m power cord * 1	1.5m DVI cable * 1	0.5m DVI cable * 4
		
1.5m USB cable * 1	Operation CD * 1	User manual * 1
		
BNC-RCA adapter * 2	PCB audio adapter * 2	

## Chapter 3: Hardware Connection

### 3.1 Diagram of signal ports on rear panel



Pic 3-1 Diagram of signal ports on rear panel

- ① Video input port    ② DVI output port    ③ Communication port    ④ Audio port

### 3.2 Ports description

#### 3.2.1 Inputs

LVP909 supports 8 video input signals as follows:

Ports	Description
<b>V1、 V2</b>	2 channels of Composite video input ( PAL / NTSC )
<b>VGA</b>	1 channel of PC analog signal input
<b>DVI1、 DVI2</b>	2 channels of DVI digital inputs ( compatible with HDMI 1.3 inputs )
<b>HDMI1、 HDMI2</b>	2 channels of HDMI digital inputs ( HDMI 1.3 )
<b>EXT.</b>	1 channel of extended input ( SDI / HD-SDI / 3G-SDI is an optional input )

### 3.2.2 DVI Outputs

Ports	Description
<b>DVI1、DVI2、DVI3、DVI4</b>	4 channels of DVI output port to connect LED sending cards or monitors.

### 3.2.3 Communication ports

Ports	Description
<b>LAN</b>	TCP/IP local area network control interface
<b>USB</b>	USB Communication port
<b>RS232 In</b>	Serial communication interface, connected to PC through RS232 port to realize PC software control
<b>RS232 Out</b>	Serial communication output cascading, RS232 LEV, it can control several processors by only one PC

### 3. 3 Hardware connection diagram

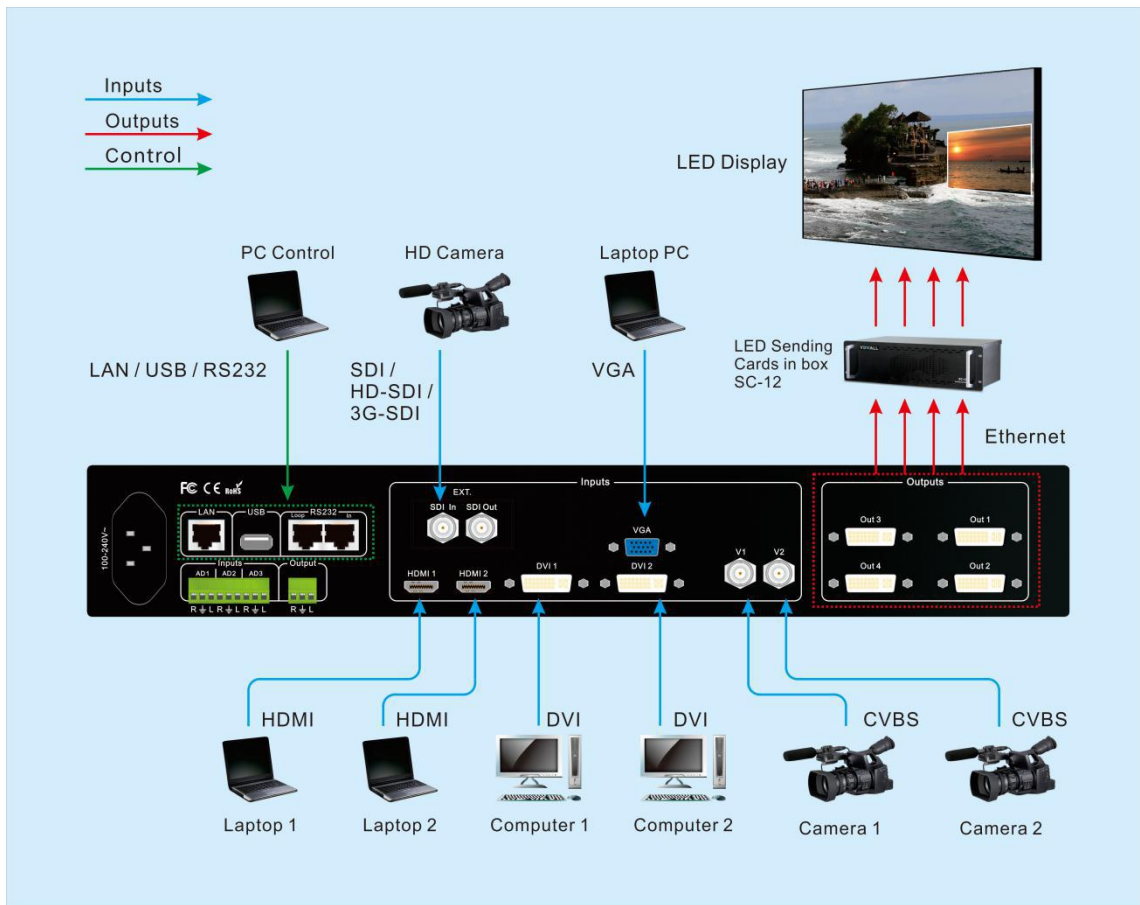

Pic 3-3a LVP919 Hardware connection diagram

### 3.4 Technical specification

Specification of Inputs		
Quantity / Type	2×CVBS 1×VGA (RGBHV) 2×DVI (VESA / CEA-861) 2×HDMI (VESA / CEA-861) 1×SDI (HD-SDI / 3G-SDI) (Optional)	
Composite Video Input SYS	PAL / NTSC	
Composite Video Amplitude Impedance	1V (p_p) / 75Ω	
VGA Format	PC (VESA Standard)	≤1920×1200_60Hz
VGA Amplitude the impedance	R、G、B = 0.7 V (p_p) / 75Ω	
DVI Format	PC (VESA Standard)	≤1920×1200_60Hz
	HDMI1.3 (CEA-861)	≤1080p_60Hz
HDMI Format	PC (VESA Standard)	≤1920×1200_60Hz
	HDMI1.3 (CEA-861)	≤1080p_60Hz
SDI Format	SMPTE259M-C	480i_60Hz
	SMPTE 292M	576i_50Hz
	SMPTE 274M / 296M	720p、1080i、1080p
	SMPTE 424M / 425M	
Input Interface	CVBS: BNC VGA: 15pin D_Sub (Female) DVI: 24+1 DVI_D HDMI: Type-A HDMI port SDI: BNC / 75Ω	
Type/Quantity of Audio Outputs	Analogous Dual Audio Channel x3+ (HDMI with embedded audio)	
Audio Amplitude the Impedance	2.0Vp-p/10KΩ	
Specification of Outputs		
Quantity / Type	4 x DVI	



DVI Format	1024 x 768_60Hz      1280 x 1024_60Hz 1440 x 1440_60Hz      1920 x 1080_50/60Hz 1920 x 1200_60Hz      2560 x 816_60Hz 2880 x 800_60Hz      3072 x 720_60Hz 3600 x 600_60Hz      1200 x 1600_60Hz 1600 x 1344_60Hz
Output Interface	DVI OUT: 24+1 DVI_D
Type/Quantity of Audio Outputs	Analogous Dual Audio Channel x1
Load Impedance of Audio Outputs	70mW/32Ω or 105mW/16Ω
Others	
Control Port	RS232 / USB / LAN
Voltage of Input	100-240VAC 50 / 60Hz
Power Consumption	≤35W
Temperature of Environment	0-45°C
Humidity of Environment	15-85%
Size of Product	482.6 (L) x274 (W) x66.6 (H) mm
Packing Size	535 (L) x400 (W) x145 (H) mm
Weight	G.W.: 5.6Kg, N.W.: 3.7Kg

**Product Dimensions:**

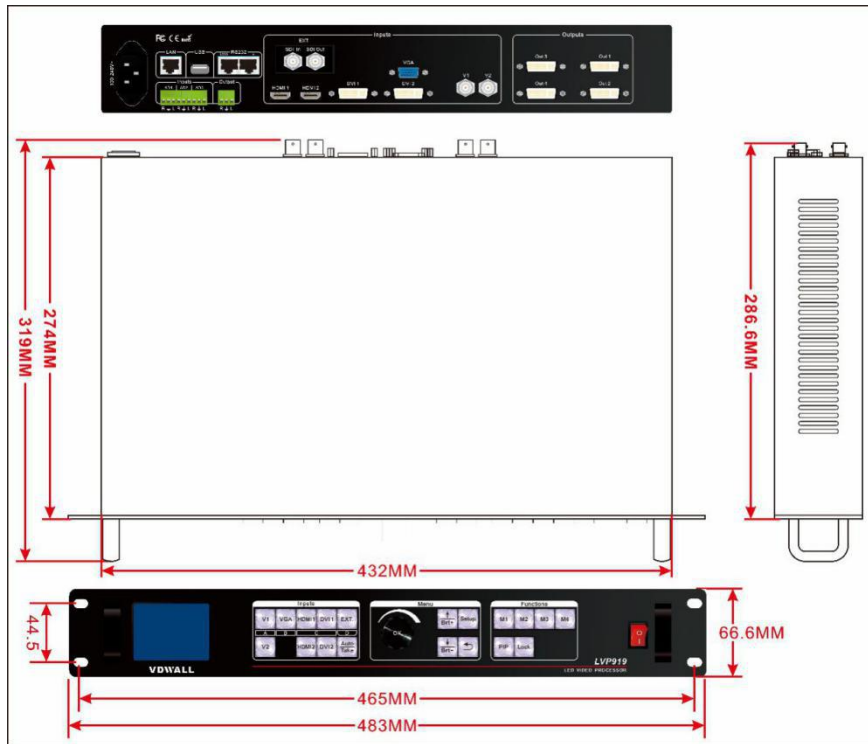

Pic 3-4a LVP919 Product Dimensions

**RS232 cable order:**

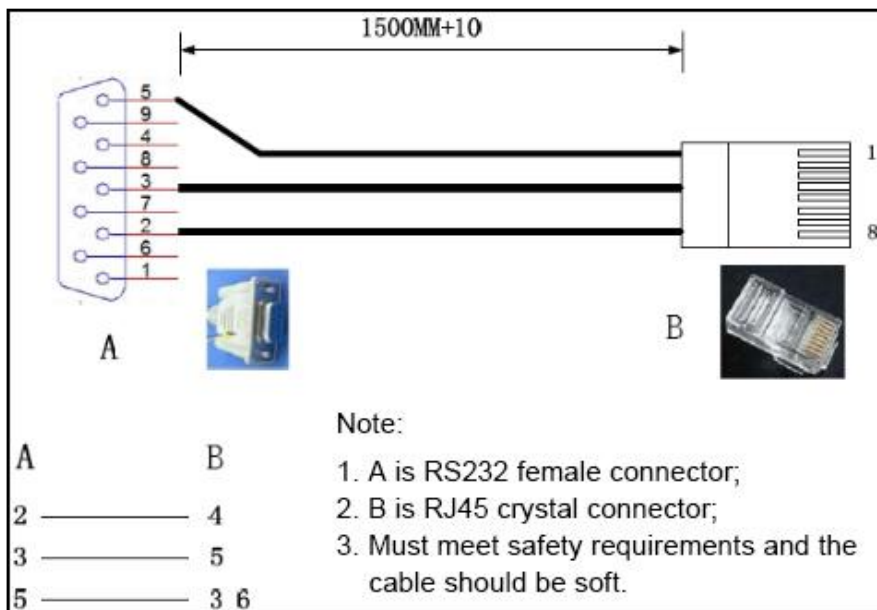

Pic 3-4b RS232 converted to RJ45 cable order

## Chapter 4: Description for front panel buttons

### 4.1 Sketch map of front panel buttons

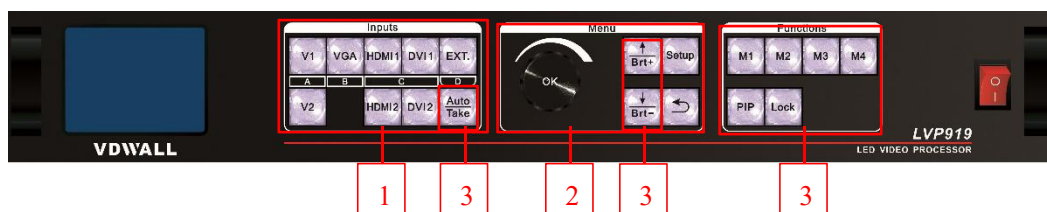

Pic 4-1 Sketch map of front panel buttons

- ① Selection buttons of input signals    ② Setup buttons    ③ Other function buttons

#### 4.1.1 Selection buttons of input signals

Selection buttons of input signals are used for selecting input signals.

**V1**、**V2**、**VGA**、**DVI1**、**DVI2**、**HDMI1**、**HDMI2**、**EXT.**



**Take**: switch from current signal to the pre-select signal under **Pre.+Take switching** mode.

#### 4.1.2 Setup buttons

Setup buttons: set images output parameters.

**Setup**、、、**Knob**、

**Setup**: Enter the setup menu

、: Select setup options

**Knob**: Knob this button to adjust values or parameters

**OK**: Press this button to save parameters

: Return to the previous item

**Auto**: Can be used to switch the current outputs while it is on outputs parameter menu.

#### 4.1.3 VGA auto-adjustment buttons

VGA auto-adjustment buttons (**Auto**): Adjust VGA input signals automatically.

#### 4.1.4 Brightness adjustment buttons

Brightness adjustment buttons (**Brt+**, **Brt-**): Adjust the output brightness of video processors.

#### 4.1.5 PIP function buttons

**PIP**: Turn on/off the function "picture in picture" or "picture by picture". When the indicator is on, that means this function is ready.

**Knob**: Knob and press it to switch PIP Mode when PIP is on.

#### 4.1.6 Splice mode buttons

Splice mode buttons (**M1**, **M2**, **M3**, **M4**): call and set the display modes, call splice modes, call PIP modes on PIP menu.

#### 4.1.7 Lock button

Lock button ( **Lock** ): lock all buttons. When lock is on. The red light will be on all the time. The other buttons are not available the Lock button. Press Lock button for 3 times without stop to unlock this function, the red light is off.

#### 4.1.8 Information button

On the state of switching channel, knob it and check the input and output parameters of all the interfaces, press OK to check the current settings and information of LVP919.

## Chapter 5: Instructions of basic operations for users

After LVP919 is powered on, LVP909 will automatically detect the device information and enter the user operating status before shutdown last time including switching status, PIP/POP status, parameter, etc. We would describe it on usual basic operations below.

### 5.1 Selection from input signals

LVP909 supports two sorts of signal switching way including one key switch and Pre.+Take switch which can be set in user setup menu 3.1 switch mode. One key switch is the default switching mode. Switch to a new signal by pressing input signals selection buttons. Pre.+Take switch adopts to press input signal buttons to preselect and then press TAKE button to switch from current input signal to preselect signal.

The input signals selection buttons are as the follow form :

Buttons	Description
<b>V1</b> 、 <b>V2</b>	2 channels of Composite video input (PAL/ NTSC)
<b>VGA</b>	1 channel of PC analog signal input
<b>DVI1</b> 、 <b>DVI2</b>	2 channels of DVI digital inputs (compatible with HDMI 1.3 inputs)
<b>HDMI1</b> 、 <b>HDMI 2</b>	2 channels of HDMI digital inputs (HDMI 1.3)
<b>EXT.</b>	1 channel of extended input(SDI/HD-SDI/3G-SDI is an optional input)

### 5.1.1 One key switch

LCD screen shows as following pictures:

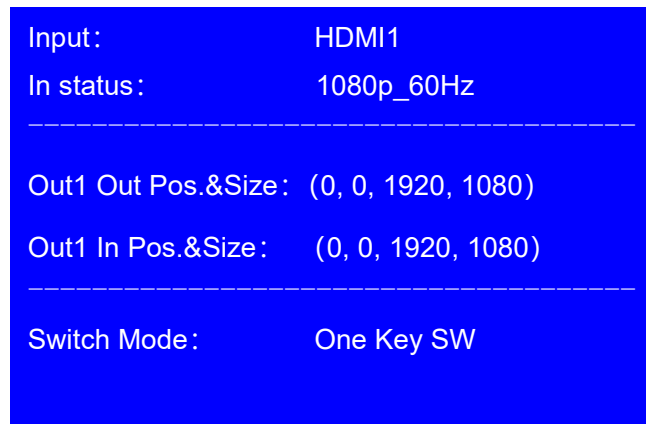

Pic 5-1a LCD display interface

LCD shows the current selected input signal source on the first row after selecting the input signal, such as: HDMI. LCD shows the status of the current selected input signal source on the second row, if there is no input signal source, it will show “No effective inputs”, and the indicator flash at the same time. If there do exist an effective input signal, then it will show the input format, such as: “ 1080p\_60Hz ”.

### 5.1.2 Pre.+Take

LCD screen shows as following pictures:

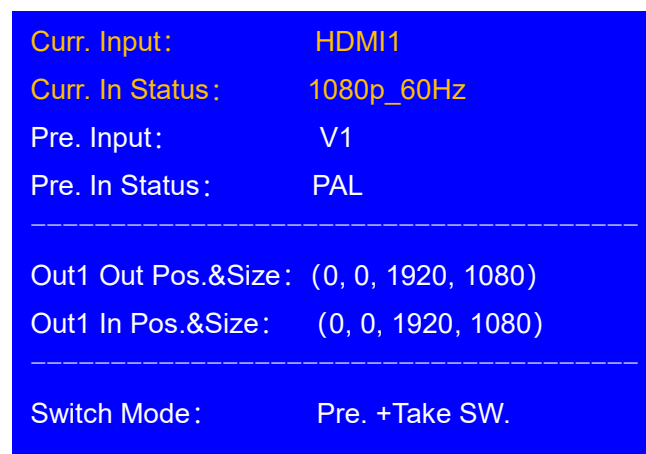

Pic 5-1b LCD display interface

Signal switching method: firstly press the input buttons to preselect the input signal, and the LCD screen will show you the current input signal and the preselected input signal, then switch the input signal between them by pressing **Take** button, after switching, the preselected input signal becomes the current input signal. If the indicator flashes quickly, it means there exist a input signal, otherwise, there is no input signal.

Attention: Pre.+Take switch is a seamless switching, we can select one input signal among these 4 groups of input signals unless they belong to the same group. For example: if the current input signal is V1 (V1 belongs to Group A) , you can only choose one input signal from Group B, Group C or Group D, the groups are as follows:

A	B	C	D
V1、 V2	VGA	DVI1、 DVI2、 HDMI1、 HDMI2	EXT.

### 5.1.3 Switching time selection

We can realize seamless switching among the 4 groups of input signals unless they belong to the same group. The switching effect includes 0 second fast seamless switching, 0.5 second、 1 second、 1.5 second fade in and fade out switching, we can enter Menu 3.2 to select the option to choose switching time.

**Cut**: switching time: **0** second, it is the default switching effect of **LVP919**.

**Fade**: switching time: **0.5** second、 **1.0** second or **1.5** second. you can realize fade in and fade outswitching among these 4 groups of input signals.

## 5.2 Operations on PIP mode

It is permitted to insert a PIP window on LVP919, this PIP input signal can be any non-grouped input signals (grouped input signals are as follows on page 18). The position and size of these dual image can be set into 4 modes. The detailed operations are as follows:

**Enter the dual picture display mode:** press **PIP** button and the indicator is on, enter the dual picture display mode, then you can press buttons to select the PIP input signal. The LCD screen will show you what the main input signal and PIP input signal is and the position and size of the corresponding image. (As follows)

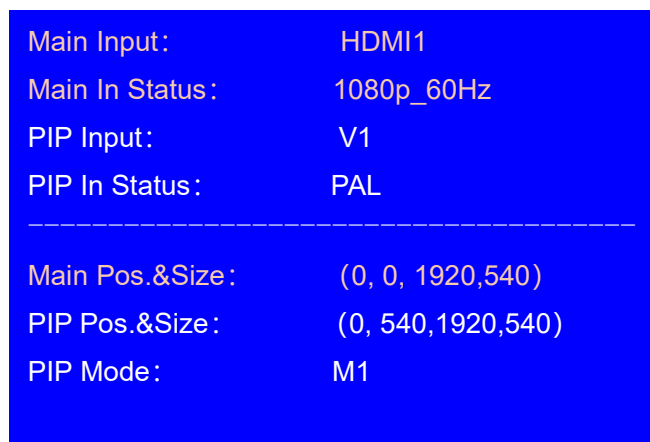
The image shows a blue LCD screen with white text. The text is organized into two sections separated by a horizontal dashed line. The first section lists input and status information, and the second section lists position and size information.

Main Input:	HDMI1
Main In Status:	1080p_60Hz
PIP Input:	V1
PIP In Status:	PAL
-----	
Main Pos.&Size:	(0, 0, 1920,540)
PIP Pos.&Size:	(0, 540,1920,540)
PIP Mode:	M1

Pic 5-2a LCD display interface

**Change the PIP input:** press the corresponding button to select a input signal and this selected input signal is the PIP input.

**Change the main input:** press those buttons to select the main input signal after pressing PIP button and close PIP mode. Then press PIP button and select the PIP input signal.

**Switching PIP mode:** when dual picture mode is on, you can knob to switch the PIP mode, and press **OK** to switch to the pointed display mode.



## 5.3 Call mosaic application mode

LVP919 can preset four mosaic display modes, press mode buttons (**M1**, **M2**, **M3**, **M4**) to call mosaic modes directly.

## 5.4 Other basic operations

### 5.4.1 Output brightness selection (Brt+, Brt-)

LVP919 supports 32-level output brightness settings. In order to ensure the integrity of the output image grayscale, the output brightness is usually set to 32!

Buttons	Description
<b>BRT-</b>	To reduce output brightness, the lowest is 0
<b>BRT+</b>	To increase output brightness, the highest is 32

### 5.4.2 VGA input auto adjustment ( Auto )

When LVP919 is under one-key directly switching mode, the current input source is a valid VGA input signal, press **Auto** to enable the LVP919 to automatically adjust the sampling parameters of the VGA input signal, making the VGA image clear and complete.

This operation is usually performed only when a new VGA source is connected. The auto-adjustment time changes depending on the condition of the input signal source, and usually does not exceed 1 minute. sometimes it's may necessary to perform this automatic adjustment several times until the VGA screen is clear, complete, and stable.

### 5.4.3 Check system information ( OK )

On the user interface, when PIP is off, knob it and you can check the input and output parameters of each port in order.

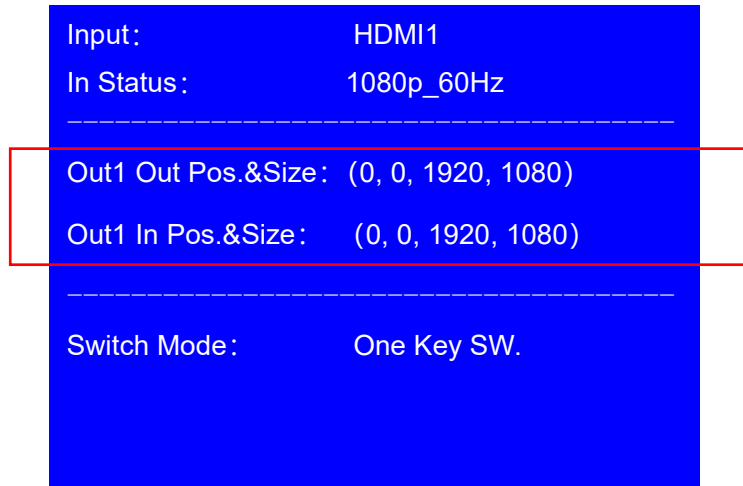

Pic 5-4a LCD display interface

In the signal switching state, press **OK** to display the current settings and information of LVP919.

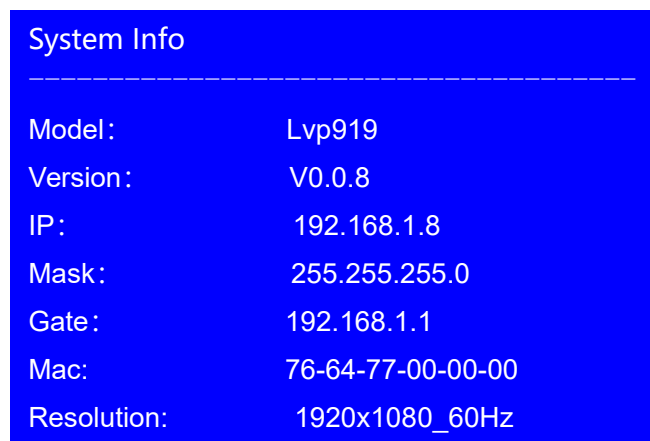

Pic 5-4b LCD display interface

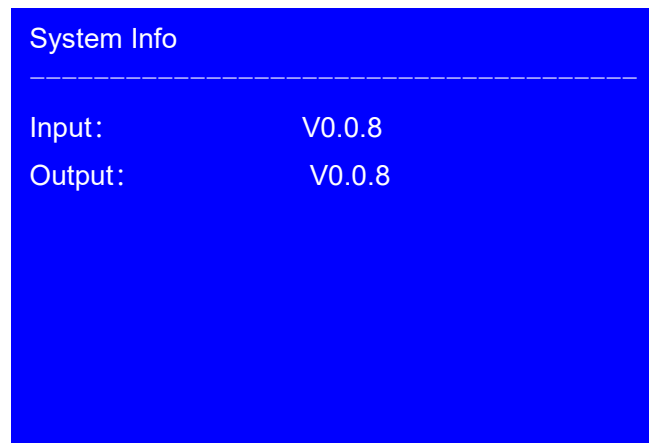

Pic 5-4c LCD display interface

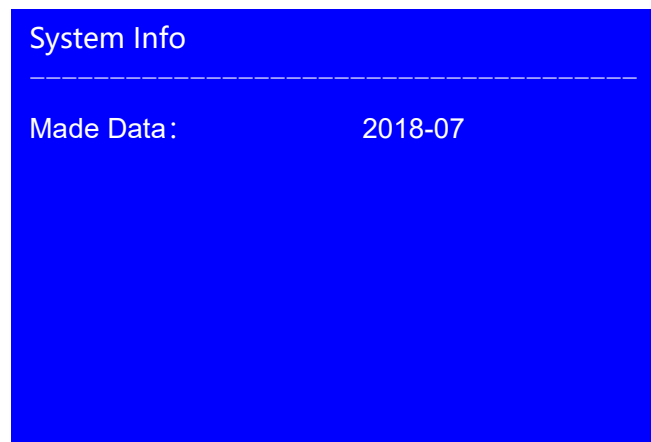



Pic 5-4d LCD display interface

## Chapter 6: User Setup Menu Instructions

The user setting menu is the setting for the total processor and is divided into 8 major modules: output image, PIP, input video signal, color&brightness,etc, communication, language, audio, and advance.



Pic 6 LCD display interface

After the system start, press **Setup** to enter user setup menu. Press  buttons to select corresponding setting items. Then press knob button( **OK** )to enter and press  to return to the previous menu. Here we will explain the detailed functions of each menu.

## 6.1 Output image

After the system start, press **Setup** to enter the user setting menu. Select 1.output image through **↑**, **↓** under this menu. Press the knob button (**OK**) to enter the following diagram 1.output image menu.

This menu can set the output resolution and output image mosaic.

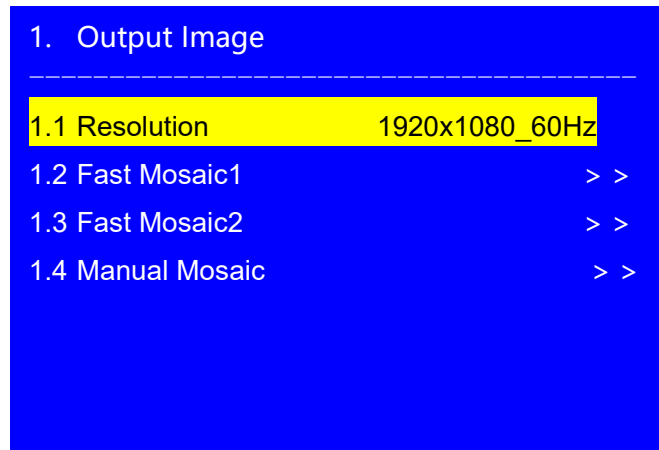

Pic 6-1a LCD display interface

### 6.1.1 Change the output resolution

Operation method:

Press **↑** or **↓** button to select 1.1 resolution. Turn the knob button to select the right parameter.

Press **OK** button. The confirmation menu appears as below. Press **OK** button again to restart the device. The changed parameters will be effective.

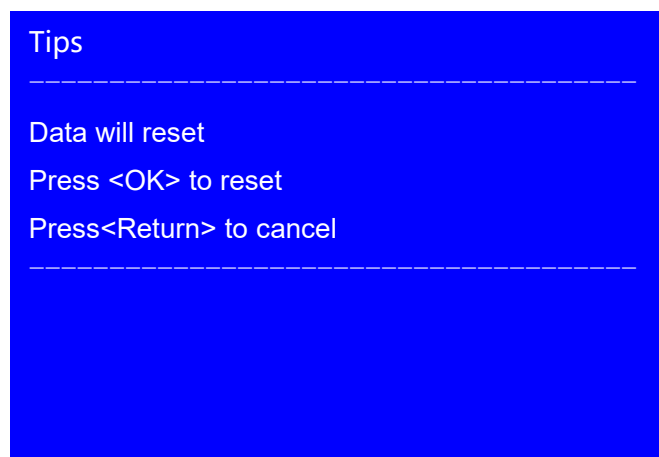

Pic 6-1b LCD display interface

### 6.1.2 Mosaic settings

There are three mosaic menus, the specific menu items and differences are as follow,

Mosaic menu items	Description
1.2 Fast Mosaic1	used for LED screen regular mosaic, such as two rows and one column (1x2), etc.
1.3 Fast Mosaic 2	Fast mosaic by input LED display screen and corresponding LED unit screen parameters.
1.4 Manual Mosaic	For fine adjustment of parameters after fast mosaic, or manual input the input and output parameters of each port.

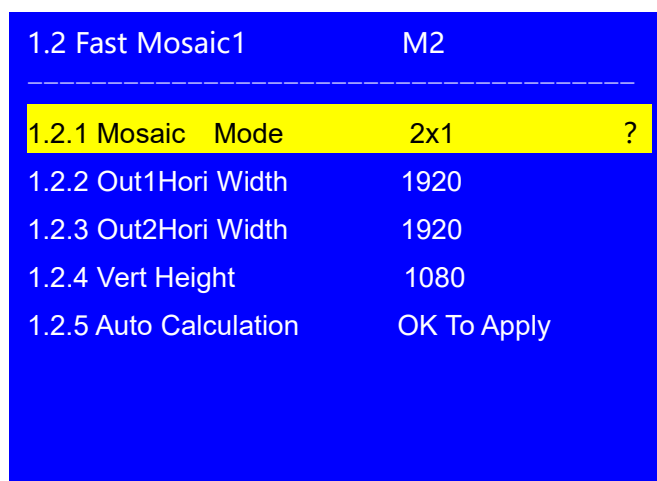

Pic 6-1c LCD display interface

Fast Mosaic 1 operation method :

1. Firstly confirm that the LED screens have the same point spacing, and arranged according to the rules of x row x column, and then select the corresponding mosaic mode, such as 1x2;
2. Press the display mode button (**M1**, **M2**, **M3**, **M4**) to select the required display mode;
3. Then press **↓** to select setting options, rotate knob to set the width and height of the display by row and column in turn;
4. Then press **↓** to select **1.2.5 Auto Calculation** option, press **OK** to save;
5. If mosaic is biased, enter **1.4 Manual Mosaic** to fine adjust input and output parameters.

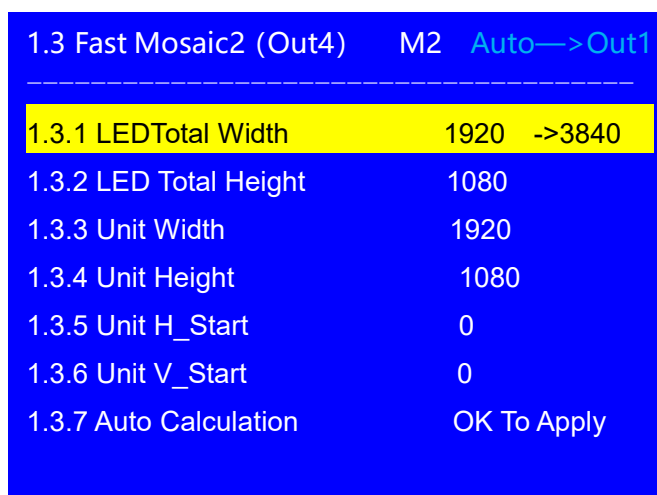

Pic 6-1d LCD display interface

Options	Descriptions
1.3.1 LED Total Width	The width and height of the total mosaic screen
1.3.2 LED Total Height	
1.3.3 Unit Width	The size of the LED screen driven by this port and position relative to the total mosaic screen
1.3.4 Unit Height	
1.3.5 Unit H_Start	
1.3.6 Unit V_Start	
1.3.7 Auto Calculation	Apply automatic mosaic parameters

#### Fast Mosaic2 Operation method:

1. Firstly press display mode button (**M1**, **M2**, **M3**, **M4**) to select required setting mode ;
2. Press **Auto** switching to the required to adjust output port (Out1~Out4);
3. Set the total width and height of the entire LED screen that need to mosaic in turn, and the size of the LED screen driven by the output port and the initial position relative to the entire LED screen;
4. Enter setting menu 1.3.7 Auto Calculation press **OK**, LVP919 will automatically calculate mosaic;
5. If mosaic is biased, enter 1.4 Manual Mosaic to fine adjust input and output parameters.

1.4 Manual Mosaic (Out4) M2 Auto-->Out1			
1.4.1 In Width	1920	->1916	1920
1.4.2 In Height	1080		1080
1.4.3 In H_Start	0		0
1.4.4 In V_Start	0		0
1.4.5 Out Width	1920		1920
1.4.6 Out Height	1080		1080
1.4.7 Out H_Start	0		0
1.4.8 Out V_Start	0		0

Pic 6-1e LCD display interface

Adjustment items	Description
1.4.1 In Width	The DVI input image position and size of the output port captured
1.4.2 In Height	
1.4.3 In H_Start	
1.4.4 In V_Start	
1.4.5 Out Width	Processor output parameters
1.4.6 Out Height	
1.4.7 Out H_Start	
1.4.8 Out V_Start	

**Manual Mosaic** operation method :

1. Firstly press display mode button (**M1**,**M2**,**M3**,**M4**) to select required setting mode;
2. Press **Auto** switching to the required to adjust output port (Out1~Out4);
3. Set the input and output parameters of this output port in turn;



## 6.2 PIP

After the system start, press **Setup** enter the user setting menu, press **↑**/**↓** to select 2.PIP in this menu, press **OK** enter 2.PIP menu, This menu can set the main image and sub-image position and size of PIP, and output image mosaic.

2. PIP	M4	PIP->M1
2.1 PIP Width	960	
2.2 PIP Height	1080	
2.3 PIP H_Start	960	
2.4 PIP V_Start	0	
2.5 Main Width	960	
2.6 Main Height	1080	
2.7 Main H_Start	0	
2.8 Main V_Start	0	

Pic 6-2 LCD display interface

Operation method:

Press **PIP** to switch current PIP mode, then press **↑** or **↓** to select the setting options, rotate knob to adjust the parameters, then press **OK** to confirm parameters.

## 6.3 Input signal setting

After the system start, press **Setup** enter the user setting menu, press **↑**, **↓** to select **3.Input Video Signal**, press **OK** enter **3.Input Video Signal**, this menu is used to set the switching mode and switching time.

Switching mode can be set to **One Key SW** or **Pre.+Take SW**, The switching time can be set to 0 second seamless switching and 0.5 second, 1 second, 1.5 second fade in and out switching.

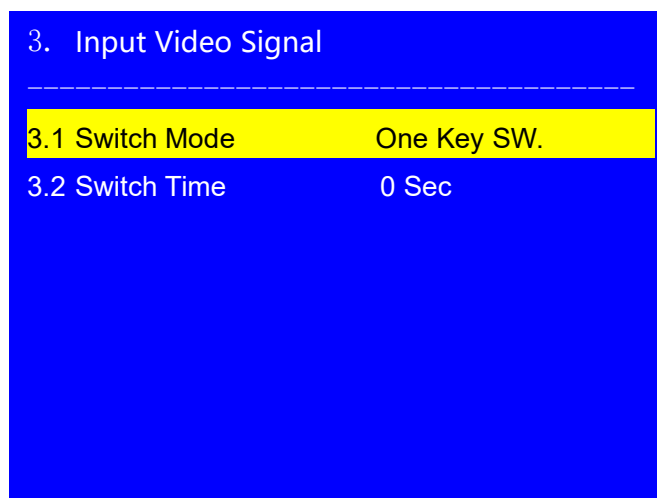

Pic 6-3 LCD display interface

Operation method:

press **↑** or **↓** to select the setting options, rotate knob button (**OK** button) to adjust the parameters, then press **OK** to confirm parameters.

## 6.4 Image quality setting

After the system start, press **Setup** to enter user setup menu. Press **↓** button to select 4.Color&Brightness,etc., Then press knob button (**OK** button) to enter 4.Color&Brightness,etc. This menu is used to set the input image brightness, contrast, and color parameters.



Pic 6-4 LCD display interface

Adjustment items	Description
4.1 Brightness	Adjustment range: 0~100, default 50
4.2 Contrast	Adjustment range: 0~100, default 50
4.3 Color	Adjustment range: 0~100, default 50

### Note:

1. To make sure of full gray scale of output image, they are always set as default value.
2. Color parameters are only available for V1、V2、SDI and Non -RGB format HDMI.

### Operation method:

press **↑** or **↓** to select the setting options, rotate knob button (**OK** button) to adjust the parameters, then press **OK** button to confirm parameters.

## 6.5 Communication setting

After the system start, press **Setup** to enter user setup menu. Press **↓** button to select **5.Communication**, Then press knob button (**OK** button) to enter **5.Communication**. This menu can set LAN interface network communication parameters, including IP address, subnet mask, gate and MAC address. It can also number multiple LVP919 to achieve multi-machine cascade through RS232.

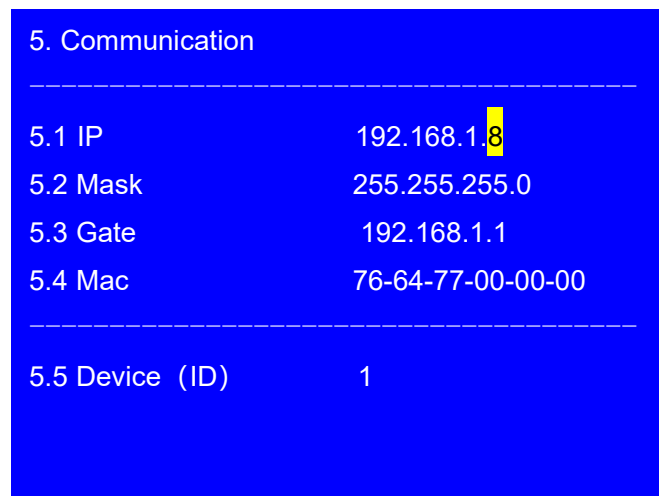

Pic 6-5 LCD display interface

### Operation method:

In **5. Communication**, press **↑** or **↓** to select the setting options, rotate knob button (**OK** button) to adjust the parameters, then press **OK** button to confirm parameters. then press **↶** button, the LCD will give tips to restart the system and follow it.

## 6.6 Language setting

LVP919 supports Chinese and English language. Rotate **Knob** button (**OK** button) to select one and press **OK** to save and effect.

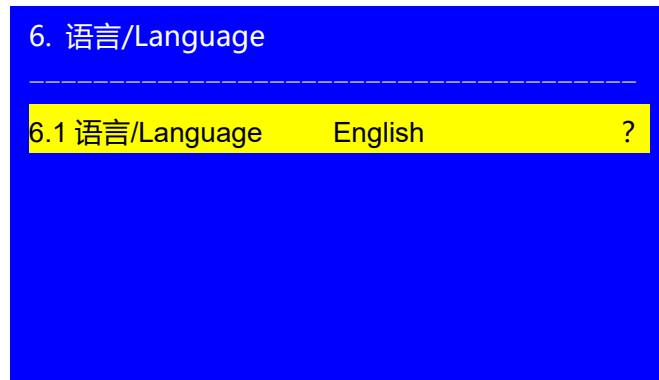

Pic 6-5 LCD display interface

## 6.7 Audio setting

LVP919 supports up to 8 channels of dual-channel audio signal switching. SDI audio and HDMI audio (only when the DVI and HDMI interfaces are connected to the HDMI signal) are audio embedded in the signal, and the other three AD1, AD2, and AD3 are external input audio. AD1, AD2, AD3 can be configured as the corresponding audio input of any input of all video inputs respectively, and switch synchronously with the switching of the video input signal.



Pic 6-7 LCD display interface

**Operation method:**

↓ button to select the corresponding audio configuration menu, turn the knob to change the input signal configured by the audio port, press **OK** to save.

If SDI and HDMI are configured as external input audio, the external audio signal input will be selected when switching to SDI, otherwise the audio embedded in the SDI signal itself will be selected as the input.

## 6.8 Advanced setting

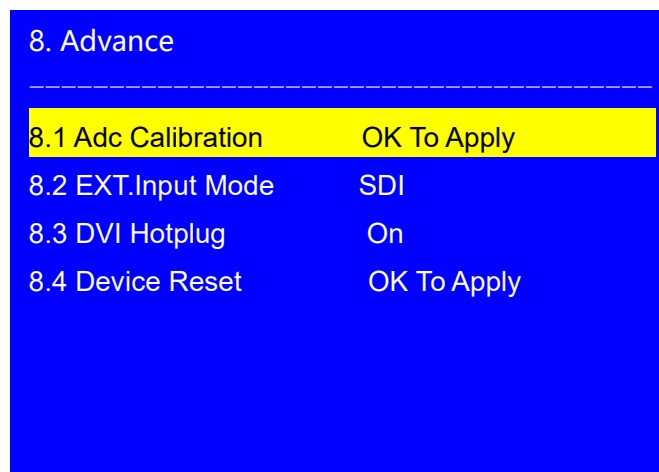

Pic 6-8a LCD display interface

### 6.8.1 ADC calibration

8.1 ADC Calibration is used to calibrate the white balance of analog signals to avoid color cast or extreme darkness problem. This function is only available for V1,V2 and VGA ports. Operation method:

In the current available Analog signals, enter **8.1 ADC Calibration** and press **OK** button to start to calibrate.

Note: Processors finished white balance calibration before leaving factory. Please use this item carefully.

## 6.8.2 EXT.Input Mode

8.2 EXT.Input Mode is used to configure extended module after the extended module is replaced, ensure extended module can work normally. Operation method:

Enter 8.2 EXT.Input Mode option, rotate the knob to select the relative module option, and press **OK** button to save. After the processor restart, the setting will come into effect.

## 6.8.3 DVI Hotplug

The DVI hot plug signal is sent by the processor to a signal source system such as graphics card, and is used as a basis for whether the signal source sends a **DVI** signal to the processor. **However, if using some software to display under a few PC systems**, sending a "hot swap signal" may cause the extended desktop playing abnormally. At this time, please enter the "8.3DVI Hotplug" option to close this function.

## 6.8.4 Device reset

8.4 Device Reset is used to reset LVP919 to factory default

Operation method: Enter 8.4 Device Reset , press **OK**. LCD will give reset tips and press **OK** to reset and restart the processor before it disappear.

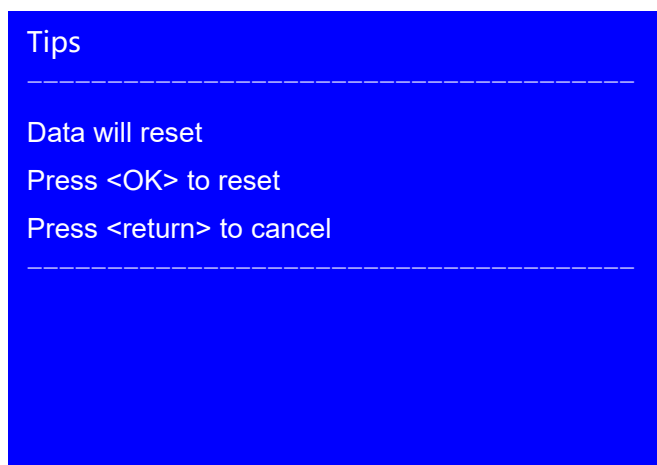

Pic 6-8b LCD display interface

## Chapter 7: Module description

LVP919: No extended module, not support SDI Input

LVP919S: have SDI extended module, support SDI input



