

Fabuletta

INSTRUCTION MANUAL

FSV001 / FSV101

VACUUM CLEANER

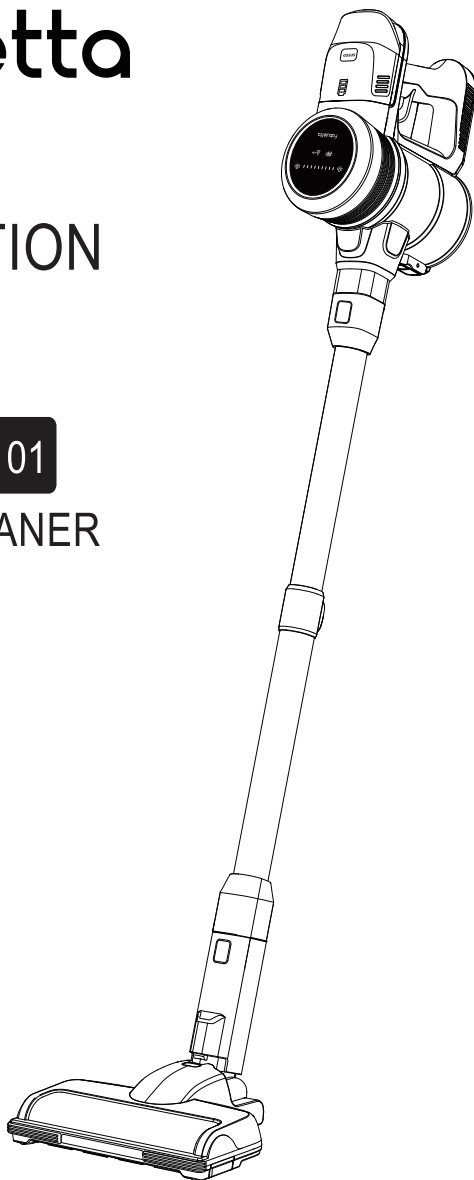

2 IN 1 FLOOR/CARPET BRUSH
24KPA POWERFUL SUCTION

IMPORTANT SAFETY INSTRUCTIONS

IMPORTANT SAFETY INSTRUCTIONS

BEFORE USING THIS APPLIANCE READ ALL INSTRUCTIONS AND CAUTIONARY MARKINGS IN THIS MANUAL AND ON THE APPLIANCE

When using an electrical appliance, basic precautions should always be followed, including the following:



WARNING

These warnings apply to the appliance, and also where applicable, to all tools, accessories, chargers or mains adapters.

TO REDUCE THE RISK OF FIRE, ELECTRIC SHOCK OR INJURY:

1. This Fabuletta appliance can be used by children aged from 10 years and above and persons with reduced physical, sensory or reasoning capabilities, or lack of experience and knowledge, only if they have been given supervision or instruction by a responsible person concerning use of the appliance in a safe way and understand the hazards involved. Cleaning and user maintenance should not be performed by children without supervision.
2. **Do not** allow to be used as a toy.
Close attention is necessary when used by or near children. Children should be supervised to ensure that they do not play with the appliance.
3. Use **only** as described in this Fabuletta Operating Manual. **Do not** carry out any maintenance other than that shown in this manual, or advised by the Fabuletta Support.
4. Suitable for dry locations **ONLY**. **Do not** use outdoors or on wet surfaces.
5. **Do not** handle any part of the plug or appliance with wet hands.
6. **Do not** use with a damaged cable or plug.
If the supply cable is damaged it must be replaced by Fabuletta, its service agent or similarly qualified person in order to avoid a hazard.
7. If the appliance is not working as it should, has received a sharp blow, has been dropped, damaged, left outdoors, or dropped into water, **do not** use and contact the Fabuletta Support.

IMPORTANT SAFETY INSTRUCTIONS

8. Contact the Fabuletta Support when service or repair is required. **Do not** disassemble the appliance as incorrect reassembly may result in an electric shock or fire.
9. **Do not** stretch the cable or place the cable under strain. Keep the cable away from heated surfaces. **Do not** close a door on the cable, or pull the cable around sharp edges or corners. Arrange the cable away from traffic areas and where it will not be stepped on or tripped over. **Do not** run over the cable.
10. **Do not** unplug by pulling on the cable. To unplug, grasp the plug, not the cable. The use of an extension cable is not recommended.
11. **Do not** use to pick up water.
12. **Do not** use to pick up flammable or combustible liquids, such as petrol, or use in areas where they or their vapours may be present.
13. **Do not** pick up anything that is burning or smoking, such as cigarettes, matches, or hot ashes.
14. Keep hair, loose clothing, fingers, and all parts of the body away from openings and moving parts, such as the brush bar. **Do not** point the hose, wand or tools at your eyes or ears or put them in your mouth.
15. **Do not** put any object into openings. Do not use with any opening blocked; keep free of dust, lint, hair and anything that may reduce airflow.
16. Use only Fabuletta recommended accessories and replacement parts.
17. **Do not** use without the clear bin and filter in place.
18. Unplug when not in use for extended periods and before maintenance or servicing.
19. Use extra care when cleaning on stairs.
20. **Do not** install, charge or use this appliance outdoors, in a bathroom or within 3 metres (10 feet) of a pool. **Do not** use on wet surfaces and do not expose to moisture, rain or snow.
21. Use **only** Fabuletta chargers for charging this Fabuletta appliance. Use **only** Fabuletta batteries: other types of batteries may burst, causing injury to persons and damage.
22. FIRE WARNING – **Do not** place this product on or near a cooker or any other hot surface and **do not** incinerate this appliance even if it is severely damaged. The battery might catch fire or explode.

IMPORTANT SAFETY INSTRUCTIONS

23. Always turn 'OFF' the appliance before connecting or disconnecting the motorised brush bar.
24. FIRE WARNING – **Do not** apply any fragrance or scented product to the filter(s) of this appliance. The chemicals in such products are known to be flammable and can cause the appliance to catch fire.

READ AND SAVE THESE INSTRUCTIONS

SAFETY INSTRUCTION

READ AND SAVE THESE INSTRUCTIONS
THIS MACHINE IS INTENDED FOR HOUSEHOLD
USE ONLY.

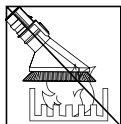

Do not use near open flames.

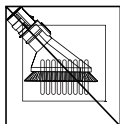

Do not store near heat sources.



Do not put hands near the brush bar when the machine is in use.

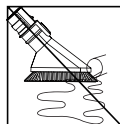

Do not pick up water or liquids.

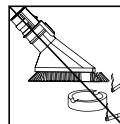

Do not pick up burning objects.

USING YOUR MACHINE
PLEASE READ THE “SAFETY INSTRUCTIONS”
IN THIS OPERATING
MANUAL BEFORE PROCEEDING OPERATION.

- **Do not** use outdoors or on wet surfaces or to vacuum water or other liquids –electric shock could occur.
- Ensure the machine remains upright in use. Dirt and debris may be released if it is turned upside down.
- **Do not** operate while checking for blockages as doing so could result in personal injury.
- For domestic indoor and car use only. **Do not** use it while the car is in motion or while driving.
- Use appropriate mounting hardware for your wall type and ensure that the docking station is mounted securely. Ensure no pipe work (gas, water, air) or electrical cables, wires or ductwork are located directly behind the mounting area.

PRODUCT INSTRUCTIONS

Product parts introduction

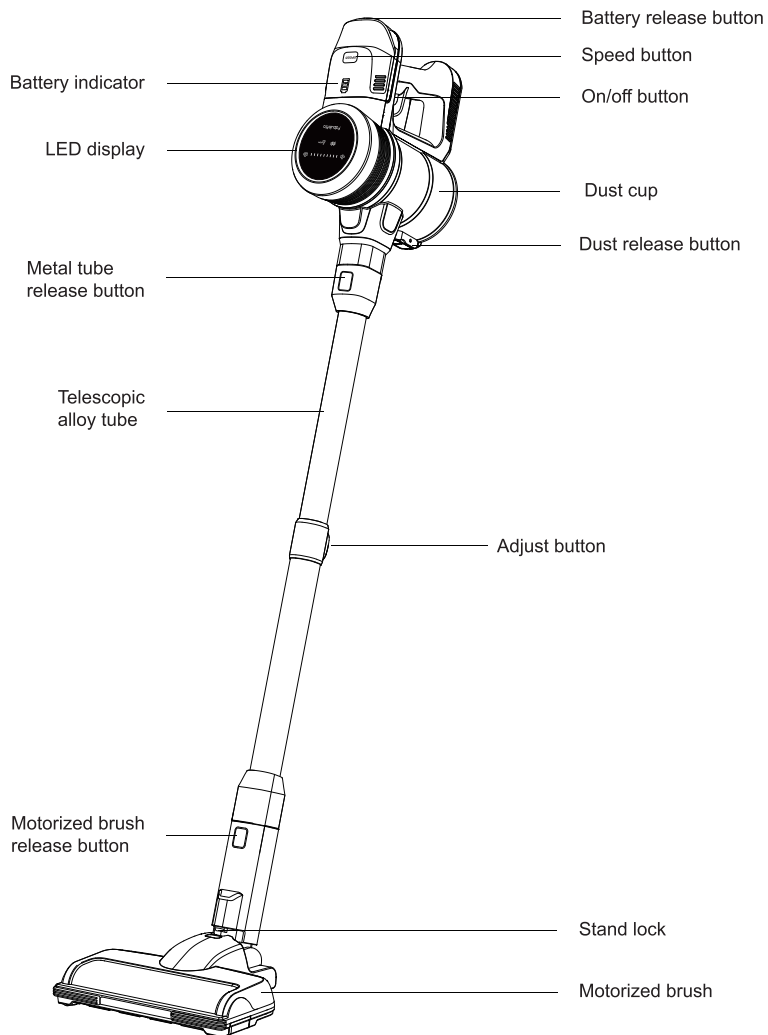

PRODUCT INSTRUCTIONS

FSV001 Accessories:

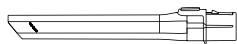

Long Crevice



HEPA Filter

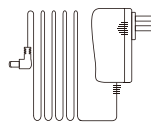

Adapter

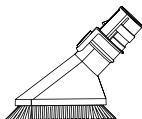

Dust Brush

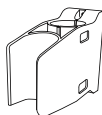

Wall Mount

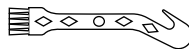

Cleaning Tool

FSV101 Accessories:

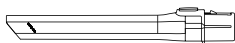

Long Crevice

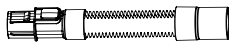

Flexible Hose



HEPA Filter

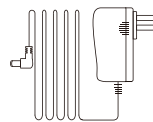

Adapter

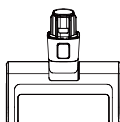

Mini Power Brush

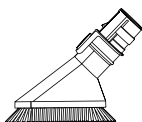

Dust Brush

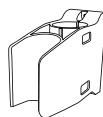

Wall Mount



Cleaning Tool

PRODUCT INSTRUCTIONS

1) Mini Power brush

High-frequency vibration helps flap out 99% embedded dust and acarids with aller-gens from your bedding and sofa.

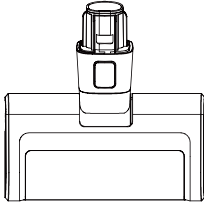

2) Long crevice

Use a hand vacuum or attach to the metal tube with this tool to clean the crevice, curtains, stairs.

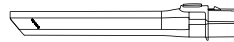

3) Flexible hose

Flexible hose can be combined with the long crevice or the brush, offers additional reach to hard-to-reach areas such as cars, corners, drawers, or bookshelf, etc.

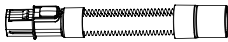

4) Dust brush

Used for cleaning bookcases, stairs, keyboards and so on.

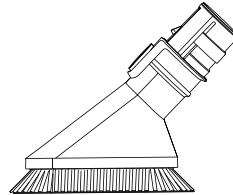

5) Cleaning Tool

Used to clean the tangled hair of the roller brush and the dust of the HEPA filter.

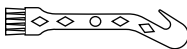

6) Wall mount

Used to store vacuum cleaners and some accessories.

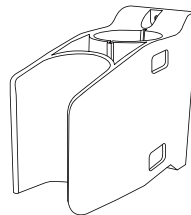

PRODUCT INSTRUCTIONS

Product Installation

1. Use as stick vacuum cleaner.

1. Insert the metal tube into the body until you hear a “click”.
Insert the motorized brush to the head of the metal tube until you hear a “click”.

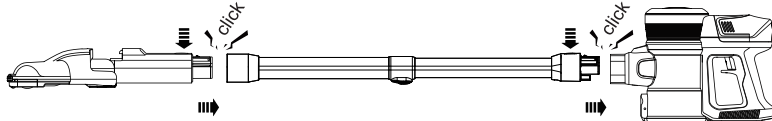

2. Press ON/OFF button, the machine will start work at middle suction level.

		Low suction level
		Middle suction level
		High suction level
		Please clean brush roller
		Please clean dust bin, HEPA filter and mesh cover immediately

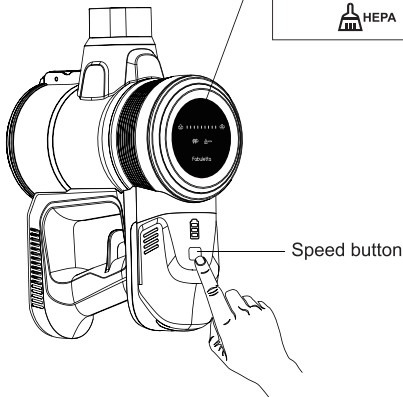

- a) Press the speed button, the machine will work at high suction level, switch to low and middle suction level by pressing SPEED button again.
- b) When the machine is working at any suction, press the ON/OFF button, the machine will stop working.

PRODUCT INSTRUCTIONS

II. Use as handy vacuum

Insert the accessory to body until you hear a click.

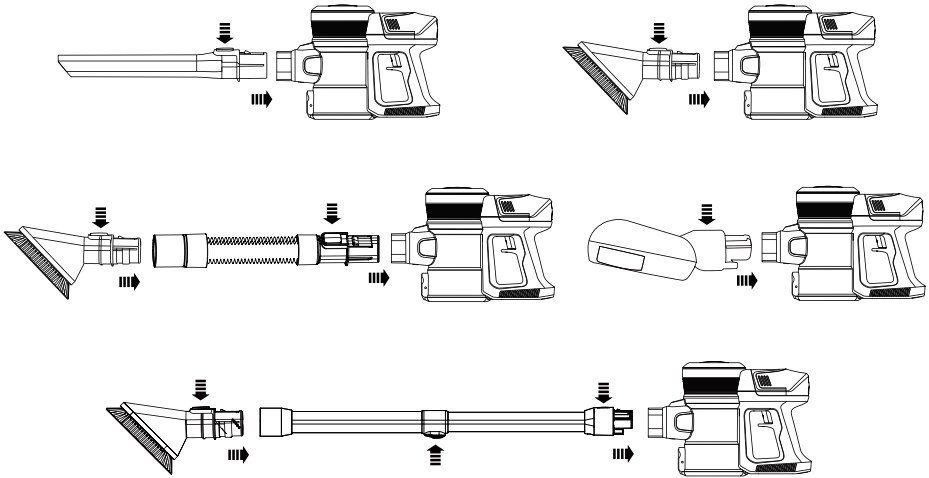

III. Battery charging

- 1) When the power indicator flashes for seconds and turns off, indicating that the power has been used up. Please plug the charger adapter into household socket for charging.
- 2) When the green light on the machine starts to flash, indicating the machine is in charging.
- 3) When the power indicator is always on and no longer flashing, it means that the machine is fully charged.

Charging mode : directly insert into the charging socket of the battery pack to charge.

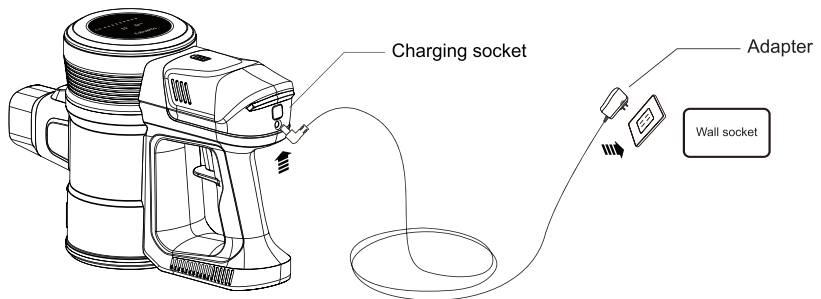

PRODUCT INSTRUCTIONS

Product storage

Fix the wall mount to the wall with screw;
Lock the floor brush and fix the machine to the wall mount;
Attach cleaning accessories to wall mount.

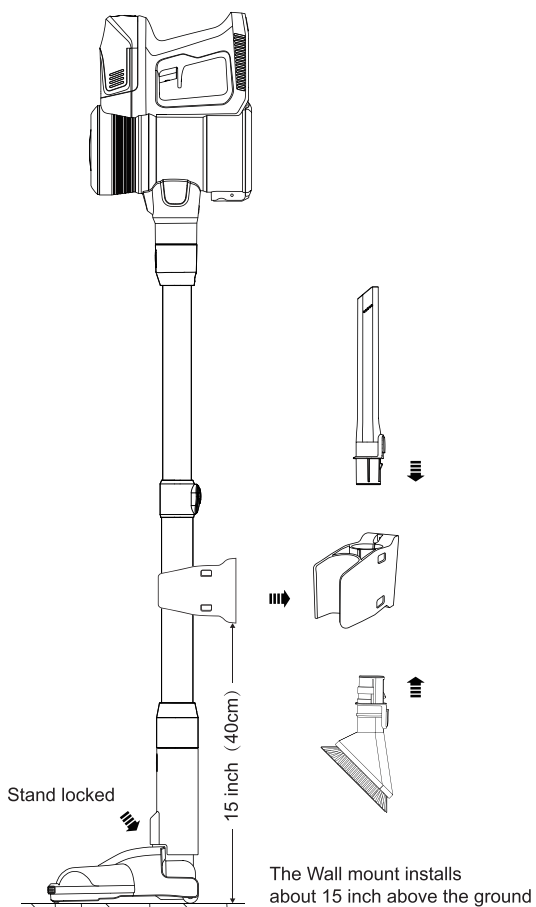

DEMOLITION INSTRUCTIONS

IV. How to empty the dust cup

- 1) Press the dust release button.

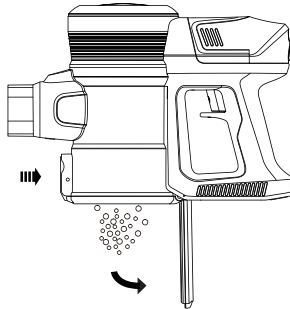

- 2) Take out filter and filter cover as below.

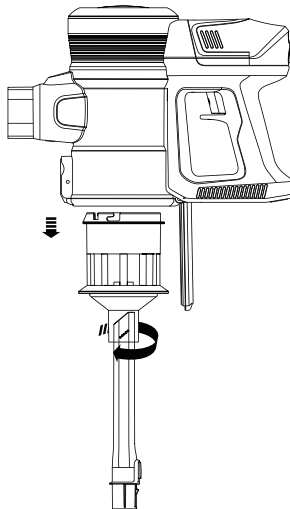

DISMANTLE INSTRUCTIONS

3) Clean the Hepa with cleaning tool.

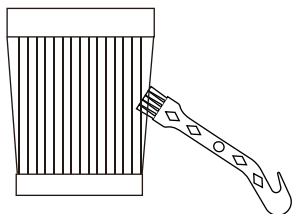

4) Clean the filter with cleaning tool.

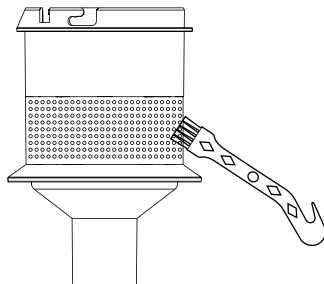

5) Put the filter back into the dust cup and lock in place.

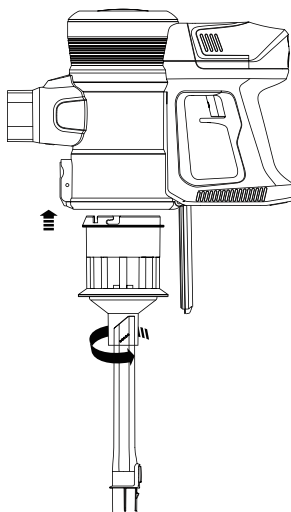

DISMANTLE INSTRUCTIONS

V. Removal method of roller brush

1) Disconnect the power supply and slide the brush lock to the right as shown in the figure.

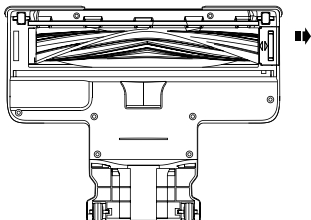

2) Slide the brush latch to the unlocked state.

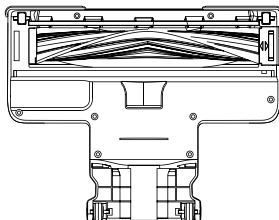

3) Take out the roller brush and clean the hair and other foreign matters on the roller brush.

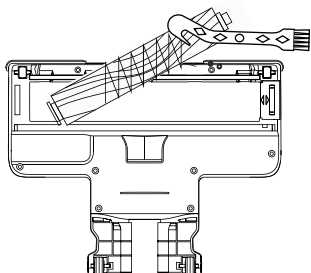

4) Install the roller brush back into the floor brush and slide the lock to the left until it is locked.

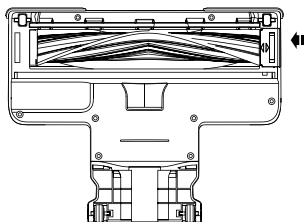

SAFETY INSTRUCTION

CARPETS OR HARD FLOORS

- Before vacuuming your flooring, rugs and carpets, check the manufacturer's recommended cleaning instructions.
- Before vacuuming highly polished floors, such as wood or linoleum, first check that the underside of the floor tool and its brushes are free from foreign objects that could cause marking.

MACHINE MAINTENANCE

- **Do not** carry out any maintenance or repair work other than that shown and described in this Operating Manual.
- Store the machine indoors. **Do not** use or store it below 37.4°F (3°C). Ensure the machine is at room temperature before operating.
- Clean the machine **only** with a dry cloth. **Do not** use any lubricants, cleaning agents, polishes or air fresheners on any part of the machine.

VACUUMING

- **Do not** use without the dust bin and filters in place.
- Fine dirt such as plaster dust or flour should only be vacuumed in very small amounts.
- **Do not** use the machine to pick up sharp hard objects, small toys, pins, paperclips, etc. They may damage the machine.
- When vacuuming, certain carpets may generate small static charges in the dust bin or wand. These are harmless and won't cause any electrical hazards. To minimize any effect from this, **do not** put your hand or insert any object into the dust bin unless you have first emptied it. Clean the dust bin with a damp cloth only.

SAFETY INSTRUCTION

- Use extra care when cleaning on stairs.
- **Do not** rest the machine on chairs, tables, etc.
- **Do not** press down on the nozzle with excessive force when using the machine as this may cause damage.
- **Do not** leave the cleaner head in one place on delicate floors.
- On waxed floors the movement of the cleaner head may create an uneven luster. If this happens, wipe with a damp cloth, polish the area with wax, and wait for it to dry.

EMPTYING THE DUST BIN

- To make emptying the dust bin easier, it is advisable to remove the wand and floor tool.
- To minimize dust/allergen contact when emptying, encase the dust bin tightly in a plastic bag to empty.
- Remove the dust bin carefully from the bag.
- Seal the bag tightly, dispose as normal.

CLEANING THE DUST BIN

- Ensure the machine is disconnected from the charger before removing the dust bin.
- Remove the wand and floor tool.
- Clean the dust bin with a damp cloth only.
- **Do not** use detergents, polishes or air fresheners to clean the dust bin.
- **Do not** put the dust bin in a dishwasher.
- Ensure the dust bin is completely dry before replacing.
- To replace the dust bin, align the tabs on the dust bin with the grooves on the main body and slide upwards into place until the catch clicks.

WASHABLE PARTS

Your appliance has washable parts, which require regular cleaning. Follow the instructions below.

SAFETY INSTRUCTION

WASHING THE FILTERS

- Wash the filters at least once a month
- The filter unit may require more frequent washing if vacuuming fine dust or frequent used.

WASHING FILTER

- Ensure the machine is disconnected from the charger before removing the filter.
- Check and wash the filter regularly according to instructions to maintain performance.
- The filter may require more frequent washing if vacuuming fine dust.
- To remove the filter, lift it out of the top of the machine.
- Wash the filter with cold water only.
- Run water over the outside of the filter until the water runs clear.
- Squeeze and twist with both hands to make sure the excess water is removed.
- Lay the filter on its side to dry. Leave to dry completely for a minimum of 24 hours.
- **Do not** put the filter in a dishwasher, washing machine, tumble dryer, oven, microwave or near an open flame.
- To refit, place the dry filter back into the top of the machine. Make sure it is seated properly.

CHARGING AND STORING

- **Do not** charge the machine and then move it to an area with a temperature below 37.4°F (3°C) for storage purposes.
- To help prolong battery life, avoid recharging immediately after a full discharge. Allow to cool for a few minutes.
- Avoid blocking the air outlet of the battery pack, which will help the battery run cooler and prolong battery life.

TROUBLESHOOTING & SPECIFICATION

TROUBLE SHOOTING

Problem	Possible solution
Not cleaning well	<ol style="list-style-type: none">1.Empty the dust bin2.Checked dust bin is correctly assembled3.Check the filter is correctly fitted4.Clean the filter
Stop or doesn't work	<ol style="list-style-type: none">1.Charge battery2.Clean the filter3. Check battery installation
Battery not charge	<ol style="list-style-type: none">1.Check connections with power cord2.Check wall socket
Power brush doesn't work	<ol style="list-style-type: none">1.Make sure dust cup assembled correctly & locked2.Make sure power brush & metal tube connected tightly3.Check the brush blocked or not

SPECIFICATION

Battery	25.9V/2200mAh
Charging period	4~5hours
Input	31V/500mA
Net. weight	2.5kg
Motor power	250W
Vacuum	MAX. 24KPA
Airflow	22dm³/s

Fabuletta ONE-YEAR WARRANTY

The One-Year Limited Warranty is valid for products purchased from our Fabuletta only, starting from the date of original retail purchase against defects in quality and materials under normal, non-commercial use.

According to the requirements outlined in this instruction manual, subject to the following conditions and exclusions.

WHAT IS COVERED

The repair or replacement of your Fabuletta appliance if your Fabuletta appliance is found to be defective due to faulty materials, workmanship or function within one year of purchase or delivery (if any part is no longer available or out of manufacture, Fabuletta will replace it with a functional replacement part).

This warranty provides, at no extra cost to you, all labor and parts necessary to ensure your machine is in proper operating condition during the warranty period.

WHAT IS NOT COVERED

Under your Fabuletta guarantee, Fabuletta shall not be liable for costs of repair or replacement of a product incurred as a result of: Accidental damage, faults caused by negligent use or care, misuse, neglect, careless operation or handling of the Fabuletta appliance which is not in accordance with this Fabuletta Operating Manual
Machines purchased from an unauthorized dealer.

Use of parts and accessories other than those produced or recommended by Fabuletta.

Repairs or alterations carried out by unauthorized parties or agents.

Use of the machine other than for normal domestic purposes within the United States, e.g. for commercial or rental purposes.

Reduction in battery discharge time due to battery age or use.

WARRANTY SERVICE

If you have a query about your Fabuletta appliance, please contact the Fabuletta customer service email : support.us@fabuletta.com
Please inform us your model name/number, purchase date ,order number, machine problem and your requirement.

Your model number can be found on rating plate. For information on your rating plate see the inside front cover.

Please keep your purchase receipt in a safe place to ensure you have this information.

Service under this warranty will not extend the period of this warranty.

WE'RE HERE TO HELP!

If you have any questions about our products, please contact our customer support team.

✉ support.us@fabuletta.com



www.Fabuletta.com

* Please have your invoice and order ID ready before contacting Customer Support.

Thanks for your purchase!
Hope you will love it as much as we do.

Fabuletta
Start your fabulous life with Fabuletta