



SET-UP GUIDE FOR

2.8W LASER ONLY KIT

A guide to assembling the MakerMade Laser Only Kit for laser engraving.

 **makermade**

v 1 Updated 1/31/22 ©Maker Made, LLC

Table of Contents

SECTION 1. Introduction- 3

SECTION 2. Laser Warnings - 4

SECTION 3. Parts Needed - 5

SECTION 3. What's in the box? - 6

SECTION 4. Assembling the laser sled - 8

SECTION 5. Choose and build frame - 12

SECTION 6. Laser driver installation - 13

SECTION 8. Appendices - 24

Calibration and Lightburn- 24

Tips and warnings - 25

Never laser material list - 26

Safe to laser material list - 27



INTRODUCTION

Thanks for buying the MakerMade Laser Only Kit and welcome to the MakerMade family! The following instructions are intended for beginners - with no prior engraving or CNC experience.

Here are some notes on the layout...

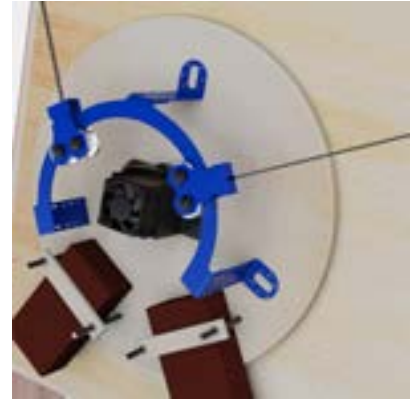

1. Setting up the laser only can be broken down into five main parts: building the laser sled, building the frame, installing the laser diode, makerverse calibration, and Lightburn configuration. This guide covers the process of building the laser sled and installing the laser diode and driver. It contains links to the Frame Guides, Calibration Guide, and Lightburn configuration guide that you need to start engraving! These are also found on our Laser Kit Resources page.

The laser only kit contains a DUE board, the brains that are also behind the M2. Any MakerMade guide for the M2 is applicable to the Laser Only Kit.

2. I'm Drew and I made this guide! My notes are tips and tricks to help you along. They are in a different blue font and look like this:

Drew's Note: Let us know how this guide can be improved. We love to hear from you!

Drew's notes are meant to answer some of the "why" questions you might have and give you tips to get started. We suggest printing the guide in color, if you want a paper copy.

3. Each step contains written instructions, a visual rendering of those instructions, color coded pictures of **sub-steps** or parts needed for that step, the **hardware bag** where you'll find the parts you'll need.

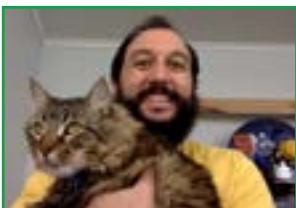

Here's me and Spaghetti,
he's not impressed with CNC



Like this Bag G in
orange

We hope you enjoy setting up your kit, happy making!





WARNING: READ BEFORE ASSEMBLING AND USING YOUR LASER ENGRAVER

By purchasing this component laser diode and driver kit you agree to the following:

- You are over 18 years of age.
- You will use these components in a safe and responsible manner and only for legal purposes.
- You fully understand and appreciate the inherent risks associated with use of a laser in any environment or circumstance.
- You expressly acknowledge that use of this product is at your own risk.
- You will exercise ordinary and reasonable care at all times while assembling and using the product. Prior to use of the product, you do not have, or are not aware of, any medical condition(s) that would prevent you from safely assembling or operating the laser device.
- You understand that these components are dangerous when not properly assembled into a finished product.
- You acknowledge and understand that you will be voluntarily engaging in use of a device which if used negligently or improperly, may result in the risk of serious injury, scarring, loss of an important bodily function, permanent disability, or death, and may cause severe social or economic losses.
- You understand and are responsible for any injury to you or any third parties or for any property damage related to your improper use or installation of the components.
- You have an understanding of electronic and mechanical devices, and are capable of incorporating this laser module safely into an existing device and as provided in the instructions.
- You will provide your own safety and protective gear, including use of appropriate eyewear. You are responsible for applying any and all appropriate safety measures during assembly and use of this product.
- You accept this laser diode module and driver as a component for integration within an appropriate machine and for the use and creation of your own materials and end products, and accept responsibility for any applicable regulations for use.
- You agree this product is designated for use solely as a component and therefore is exempt from compliance with 21 CFR § 1040.11 and § 1040.11 for complete laser devices.
- You agree to be responsible and hold Maker Made LLC harmless from any injury to person or property resulting from the use of or assembly of these components or from any products created from use of the components.



PARTS NEEDED

Tools needed for building and operating your Laser Engraver (that didn't come with your kit):

13mm Combo Wrench (or any adjustable wrench)

10mm Combo Wrench

Phillips Screwdriver/ drill

Tape Measure/Digital Caliper (for calibration)

Two Standard Sized Bricks (that attach to the sled for weight during operation)











Drew's Note: Check out our [YouTube](#) for instructions and other how to-videos!

The following is what came in your Laser kit!



WHAT'S IN THE BOX?

<p>DUE v1.2 Control Board, Shield, and Case</p> 	<p>10' MicroUSB to USB cord</p> 	<p>AC/DC Power Adapter and cord</p> 	<p>X and Y Axis Motors (2)</p> 
<p>X and Y Motor Power Cables</p> 	<p>Motor Mounting Brackets (2)</p> 	<p>Stud Mounts (4)</p> 	<p>Ring Carriage</p> 
<p>Roller Bearing Carriages (2)</p> 	<p>Z-Axis Mount L-Brackets (3)</p> 	<p>2.8W Laser Diode</p> 	<p>Laser Diode Driver</p> 
<p>Laser Power Adapter</p> 	<p>Roller Bearings (4)</p> 	<p>Chains 335cm/11' (2)</p> 	<p>Laser fan and extension cables</p> 
<p>Spring</p> 	<p>MakerMade USB</p> 	<p>Laser Mount</p> 	<p>Sled</p> 

<p>Safety Goggles</p> 	<p>Stickers, Quick Start Guide, and Welcome Letters</p> 	<p>Chain Mounting Hardware Bag 1 Cotter pins (2) Chain sprocket (2) Small nails (2) Large nails (2) White spacers (2) S-Hooks (2)</p> 	<p>Spring Hardware Bag 2 Quick links (2) Zip ties</p> 
<p>Brick Mounting Hardware Bag 3 Brick mounts (2) Large carriage bolts (4) Washers (4) Wingnuts (2) Locking nuts (2)</p> 	<p>Laser Diode Parts Bag 4 1KhZ resistor Small flathead screwdriver</p> 	<p>X/Y Motor Hardware Bag 5 Motor sprocket (2) Grub Screws (2) Motor screws (8) Motor washers (8) 3mm hex wrench</p> 	<p>DUE and Laser Mount Bag 6 Small screws (4) Small spacers (4)</p> 
<p>Bearing Carriage Hardware Bag 7 Shoulder bolt (4) Large washer (8) Large locking nut (4) 5mm hex wrench</p> 	<p>Ring and L-Bracket Hardware Bag 8 Tiny wood screws (20) Small black M3 bolts (24) 2mm hex wrench</p> 	<p>Frame Mounting Screws Bag D Black wood screws Silver wood screws</p> 	

ASSEMBLING YOUR LASER SLED

The Laser Only kit comes in several pieces to assemble.

Drew's Note: We recommend reading this entire section before beginning assembly.

Check out [this](#) link for tutorials on our YouTube!

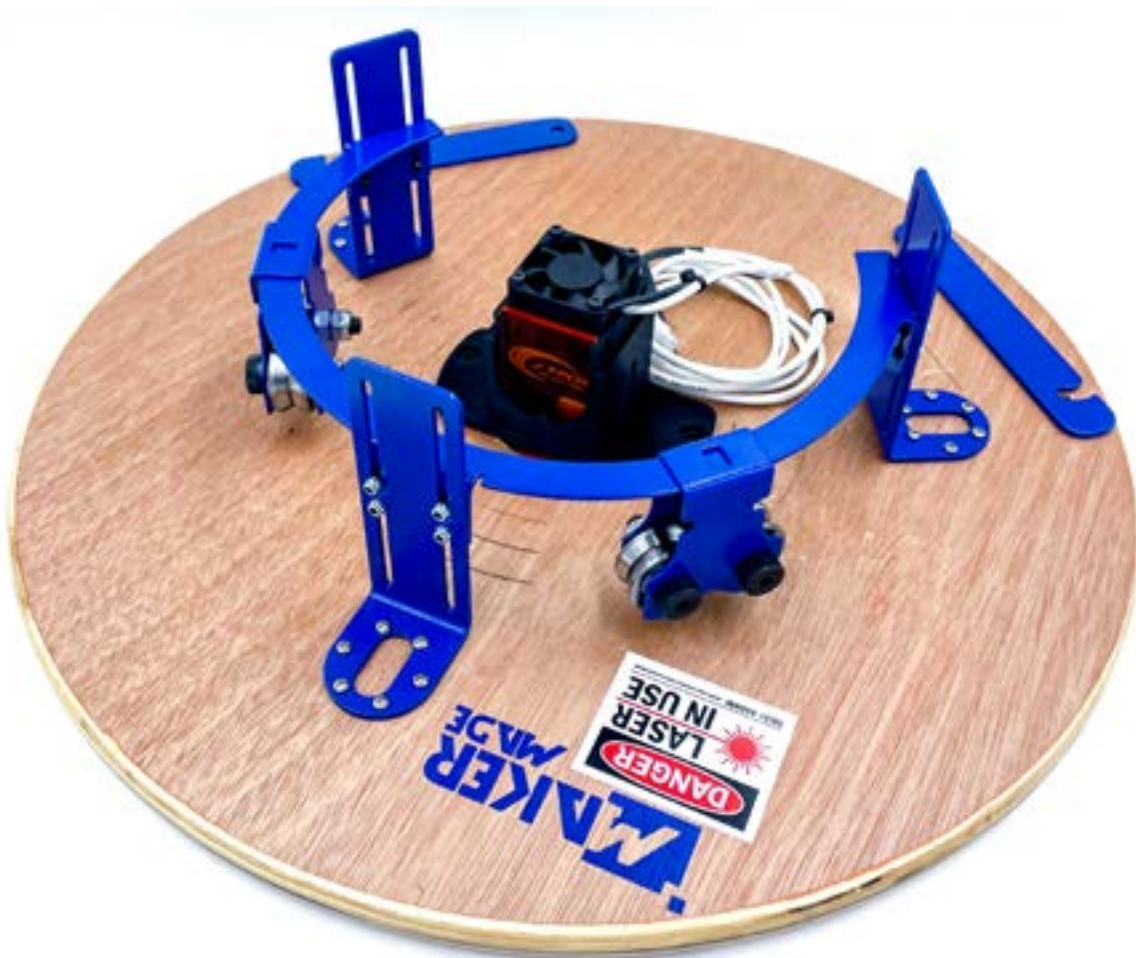

1. There are three sets of countersunk pilot holes in the sled. Place the **ring carriage** in the center and align with the pilot holes. Align the L-brackets with the ring bracket attachment on each set of holes, with the tall sides toward the center. Screw the aligned **L-brackets** into the sled, oriented with the ring carriage, using a **Phillips screwdriver** and the tiny **silver screws**.



Ring and L-Bracket



Hardware Bag 8

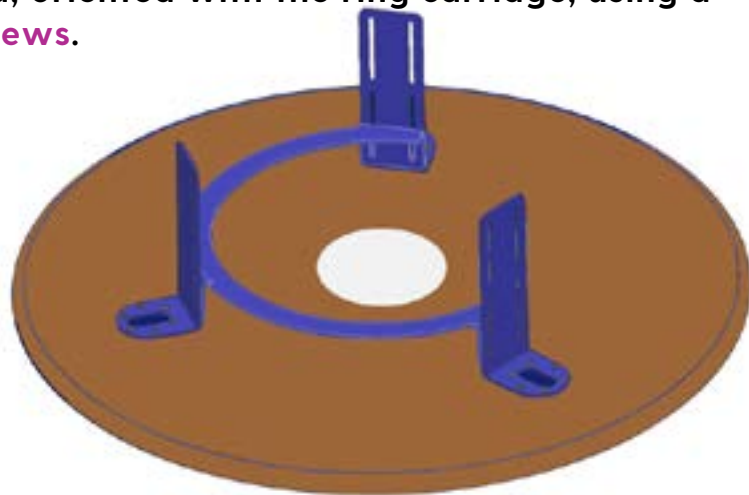

2. Attach the three L-brackets to the rectangular brackets on the ring carriage using four small **black bolts and locking nuts** on each bracket. Use the smallest **(2mm) hex wrench** on one side and a **wrench** on the other.

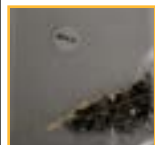

Ring and L-Bracket

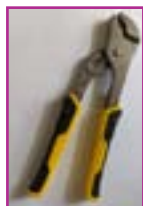
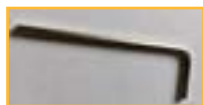

Hardware Bag 8

Drew's Note: The ring carriage is adjustable for the thickness of the material you're engraving! For now, we'll attach it at the top.

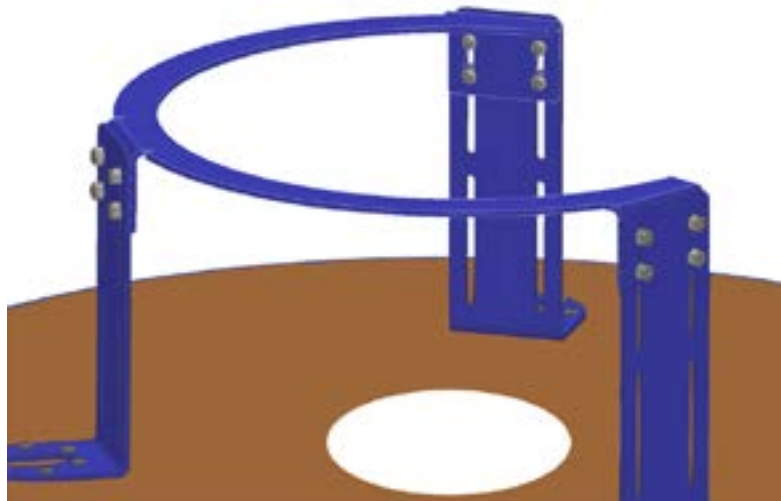

3. Hang a **roller bearing carriage** on each side of attached ring carriage.



Roller bearing carriages



4. Assemble both roller bearing carriages by inserting the shoulder bolt through larger carriage hole, then through a washer, the **ring bearing**, another washer, and out through the smaller side of the roller bearing carriage. Use the largest **(5mm) hex wrench** on one end and 13mm combo wrench (or any **wrench**) on the other to tighten.



Bearing
Carriage
Hardware
Bag 7

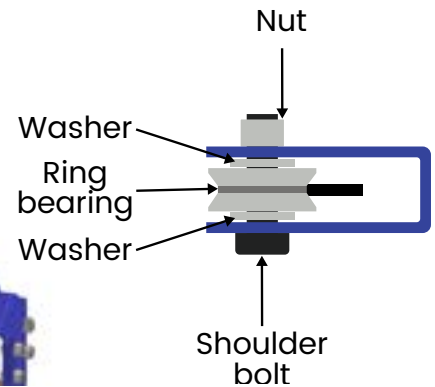
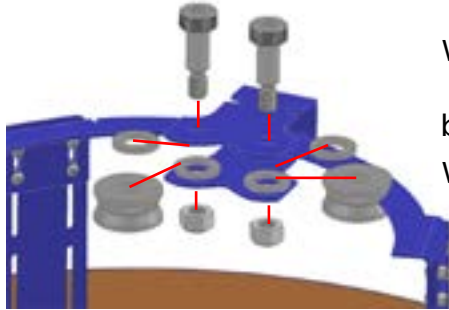

5. Place the laser mount to the sled's center hole. The half-circle side will be facing the top of the sled, toward the MakerMade logo. Use two tiny **silver screws** to attach.



DUE and
Laser Mount
Bag 6



6. To attach the brick mounts, insert the 4 large carriage bolts into the 2 left and 2 right holes on the sled. Slide the brick mounts over the bolts and then a washer on each. The wingnut goes on the open hole and the locking nut on the other. Tighten the nut with a 13mm combo wrench (or any **wrench**)



Brick Mounting
Hardware Bag 3



7. Insert Laser Module Into Laser Mount. It will snap into place with the J Tech logo toward the top of the sled, visible through the half circle in the laser mount.

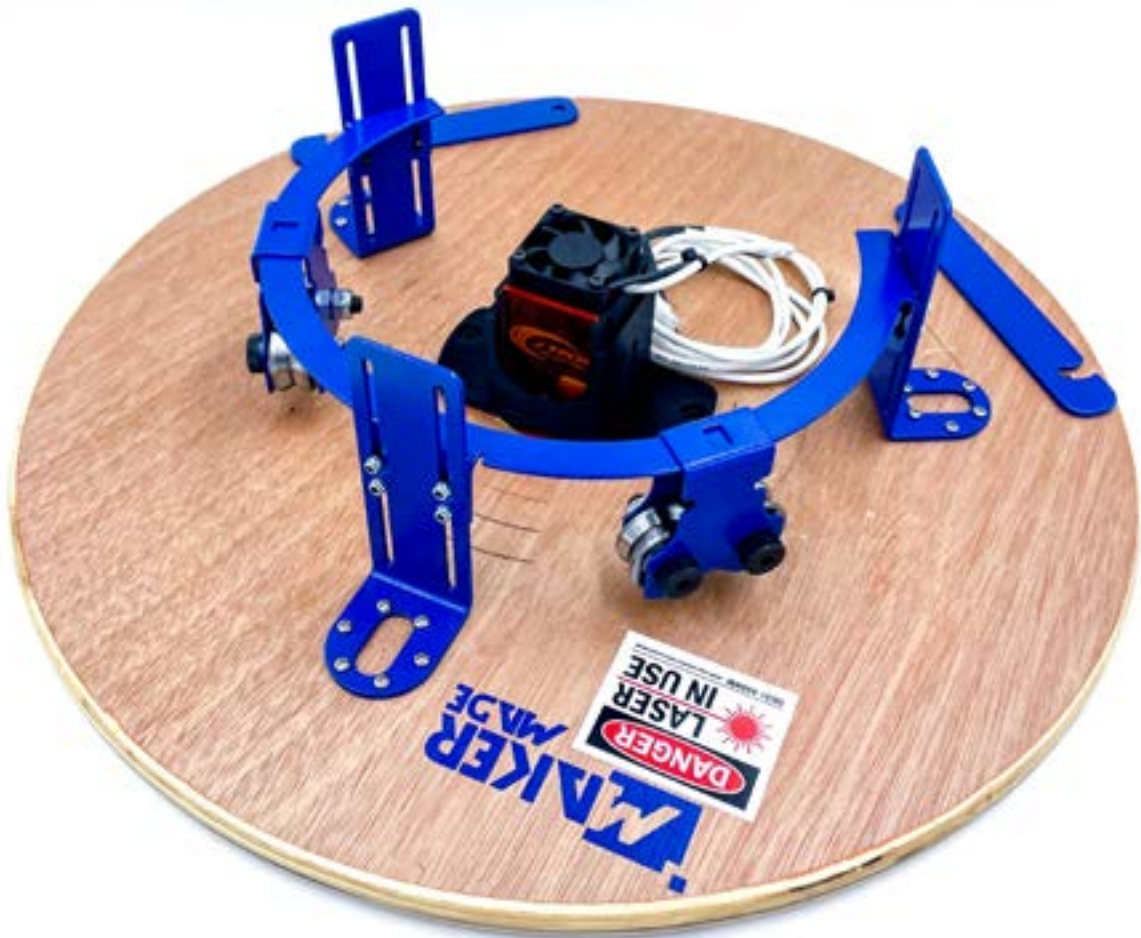

Drew's Note: Your sled is now built! The next steps are to build your frame, attach your laser driver, calibrate your Laser Only Kit in Makerverse, and setup Lightburn!

BUILD A FRAME

Now that your sled is built, you will need to construct a frame to mount your materials to engrave.

Visit our [Laser Only Resources Page](#) for instructions over how to build the mini, standard, or XL frames by MakerMade! Since your kit came with stud mounts and screws, you can follow any of the M2 frame guides to create the M2 frame that best works for you! Here are the main differences between them:



Mini Frame:
6ft Top Beam
Smaller Chain
Cuts up to 4ft x 4ft



Standard Frame:
6ft Top Beam
11ft chains (included with
your laser only kit)
Cuts up to 4ft x 8ft



XL Frame:
12ft Top Beam
15ft chains (purchased separately)
Cuts just over 4ft x 8ft

Drew's Note: Interested in coming up with your own frame design? Hop on our [Facebook Owner's Group](#) or [Forum](#) and discuss with other makers about your idea if someone has made something similar!

Follow the instructions to build your frame, attach your motors, and connect your DUE board. Once your frame is built, you're ready to attach your laser driver!

Laser Diode Driver Installation

Laser Driver Diagram

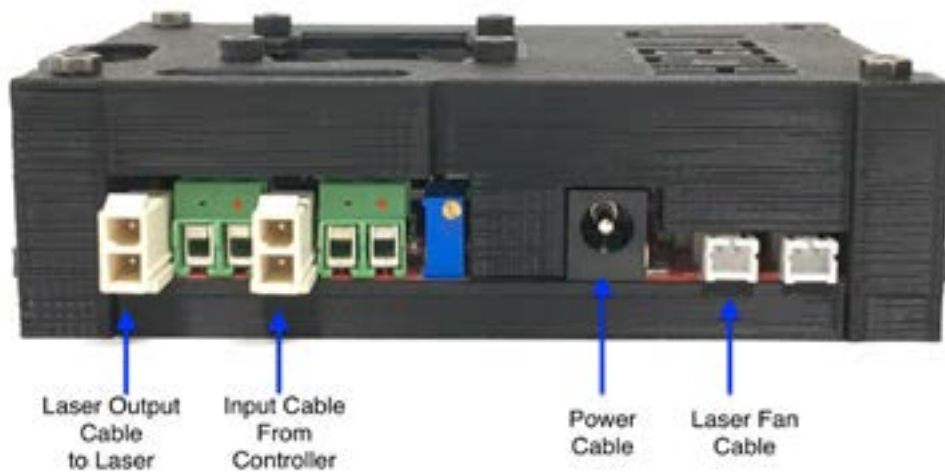
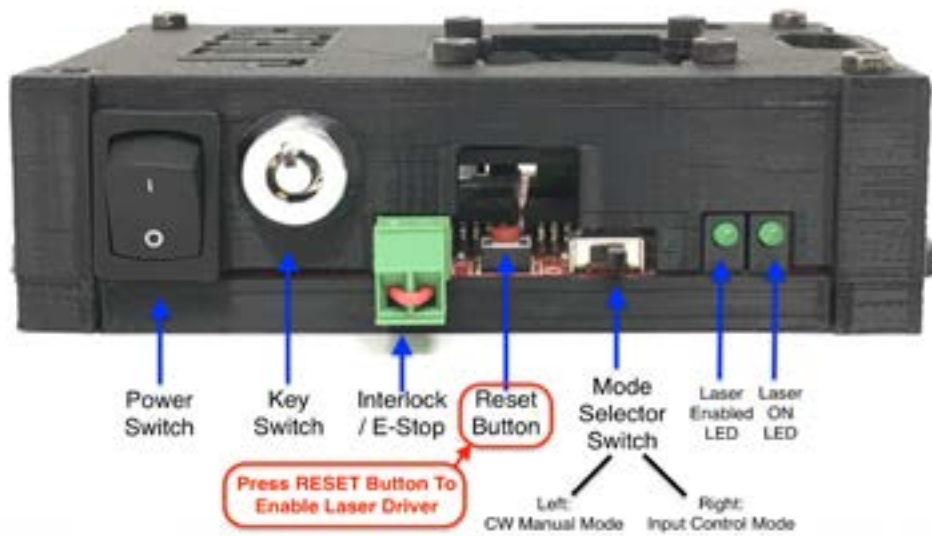

1. Mount the Laser Driver

Mount the laser driver close to the M2 control board.

You can use the sticky pads to attach the laser driver near the M2 control board or you can mount it using screws.



Make sure the Mode Selector Switch on the front of the laser driver is to the right. (Input Control Mode)

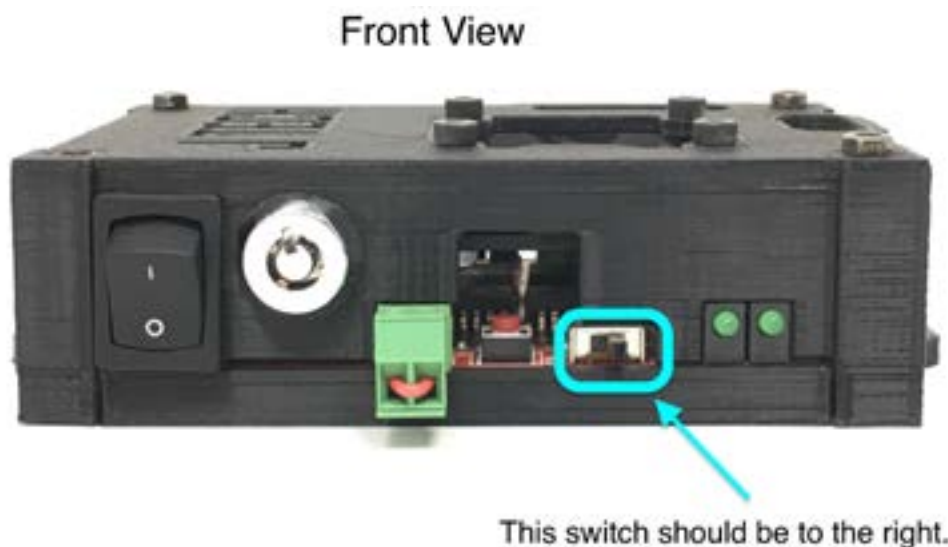

2. Run the Laser and Fan Extension Cables

The two cables in the mounting kit are the Laser Extension Cable (thicker cable) and the Fan Extension Cable (thinner cable).



Find the female end of each extension cable.

You can put a small piece of tape on the ends to keep them together.



Feed the female ends of the extension cables down behind the frame and pull the extension cables out far enough to attach to the sled.

3. Connect the Laser Driver to the Control Board

Find the Molex Mini Fit Jr. Input cable. (pictured below)

On one end is a black connector. On the other end are two wires.

The BLACK wire is the Ground.

The RED wire is the PWM or spindle speed control.

These two wires will connect to the M2 control board.





Remove the case cover from the M2 control board.



Find the green connector on the M2 control board.



If it makes it easier, you can remove the green connector plug from the motor shield by gently pulling it straight out.

Loosen the screw in the 1st position Labelled 12V.
Loosen the screw in the 2nd position Labelled GND.
Loosen the screw in the 3rd position Labelled LSR.



Laser Diode Parts
Bag 4



Insert the BLACK wire from the cable into the 2nd position on the green connector labelled GND. Tighten the screw.



Insert the RED wire from the cable into the 3rd position on the green connector labelled LSR.



Insert one end of the 1K resistor into the 3rd position on the green connector labelled LZR.
Tighten the screw.



Insert one end of the 1K resistor into the 1st position on the green connector labelled 12V.
Tighten the screw.



When you have done that, the green connector should look like the picture to the right.



If you removed the green connector plug to make these connections, snap it back into the motor shield.



The other end of the cable you just connected to the M2 control board will have a black Molex connector on it.



This black connector goes into Terminal H4 on the back of the laser driver.
(Input cable from controller)

Terminal H4 may have a black dot or line on the driver connector.
(see picture on right)



Double check to make sure this is correct. You can cause damage to the laser driver if the cable is not plugged in to the correct terminal.



4. Connect the Laser Cable to the Laser Driver

Find the opposite end of the extension cables you fed under the frame with the male connectors.

Connect the thick laser extension cable (with the clear end) to the laser driver board in Terminal H3. (Laser Output)

Connect the thin fan extension cable to the laser fan connector on the driver board.



5. Connect the Laser to the Extension Cables

Connect the laser and fan cables to the extension cables.

Ensure you have enough slack so the extension cables will be able to move freely as the sled moves around the work space.



Use zip ties to keep laser and fan extension cables neat and together.

6. Connect Emergency Stop Button (Optional)

If purchased, connect E-Stop Cable to green connector on front of laser driver.

**Please Note:*

Laser will not work without the included jumper OR E-Stop connected.



To reset the E-Stop, twist the red button to the right and the button will pop up.

Your Laser is Now Assembled!

The next step is to get started engraving projects with LightBurn and Makerverse. You can find our calibration guide and our LightBurn configuration guide on the laser resource page on our site at makermade.com/laser-resources.

Have a question or need guidance?

The MakerMade technical team is available to help! You can fill out a support ticket at: <https://makermade.freshdesk.com/support/tickets/new>

We can't wait to see what you make! Be sure to tag us in any of your projects and use our hashtags #madewithMM and #makermadeCNC!

Find us on [Instagram](#), [Facebook](#), [YouTube](#) and [TikTok](#)!

Happy Making!

- Team MakerMade



APPENDIX - TIPS

[Click here to get our calibration guide and start engraving!](#)

When used correctly, this machine is very safe. However, some safety precautions must be taken to prevent injury. These include but are not limited to:

- Always follow the safety guidelines and instructions included with the router or other tool you attach to the kit.
- Always wear ear and eye protection when running your machine.
- Use adequate dust collection or wear a respirator. Breathing material dust can be harmful.
- Use proper lifting techniques when loading/unloading materials.
- Always use caution when connecting/removing the sled. This assembly weighs around 20 lbs.
- NEVER leave your machine running unattended!
- Optionally, you can cut off the ends of the beams and the top of the vertical frame legs outside of the stud mounts, so your frame isn't as tall or long.

We're excited to have you in our community of makers and can't wait to see what you create.

Find us on [Facebook](#), [Instagram](#) and [YouTube](#) @makermadecnc and tag your projects!

#MakerMadeMaker



Never Cut These Materials

WARNING: Because many plastics are dangerous to cut, it is important to know what kind you are planning to use. Here's a How-To for identifying unknown plastics with [a simple process](#).

Material	DANGER!	Cause/Consequence
PVC (Poly Vinyl Chloride)/ vinyl/pleather/ artificial leather	Emits chlorine gas when cut!	Don't ever cut this material as it will ruin the optics, causes the metal of the machine to corrode as chlorine is released and ruins the motion control system.
Thick (>1mm) Polycarbonate/ Lexan	Cuts very poorly, discolors, catches fire	Polycarbonate is often found as flat, sheet material. The window of the laser cutter is made of Polycarbonate because polycarbonate strongly absorbs infrared radiation! This is the frequency of light the laser cutter uses to cut materials, so it is very ineffective at cutting polycarbonate. Polycarbonate is a poor choice for laser cutting. It creates long stringy clouds of soot that float up, ruin the optics and mess up the machine.
ABS	Melts / Cyanide	ABS does not cut well in a laser cutter. It tends to melt rather than vaporize, and has a higher chance of catching on fire and leaving behind melted gooey deposits on the vector cutting grid. It also does not engrave well (again, tends to melt). Cutting ABS plastic emits hydrogen cyanide, which is unsafe at any concentration.
HDPE/milk bottle plastic	Catches fire and melts	It melts. It gets gooey. It catches fire. Don't use it.
PolyStyrene Foam	Catches fire	It catches fire quickly, burns rapidly, it melts, and only thin pieces cut. This is the #1 material that causes laser fires!!!
PolyPropylene Foam	Catches fire	Like PolyStyrene, it melts, catches fire, and the melted drops continue to burn and turn into rock-hard drips and pebbles.
Epoxy	burn / smoke	Epoxy is an aliphatic resin, strongly cross-linked carbon chains. A CO2 laser can't cut it, and the resulting burned mess creates toxic fumes (like cyanide!). Items coated in Epoxy, or cast Epoxy resins must not be used in the laser cutter. (see Fiberglass)
Fiberglass	Emits fumes	It's a mix of two materials that cant' be cut. Glass (etch, no cut) and epoxy resin (fumes)
Coated Carbon Fiber	Emits noxious fumes	A mix of two materials. Thin carbon fiber mat can be cut, with some fraying – but not when coated.
Any foodstuff (such as meat, seaweed 'nori' sheets, cookie dough, bread, tortillas...)	The laser is not designed to cut food, and people cut things that create poisonous/ noxious substances such as wood smoke and acrylic smoke.	If you want to cut foodstuffs, consider sponsoring a food-only laser cutter for the space that is kept as clean as a commercial kitchen would require.
Material with Sticky Glue Backing	Coats lens, cracks lens	There are many normally laserable items such as thin wood laminates that you can purchase that become un-cuttable when the manufacturer adds a layer of peel-off glue on the bottom to attach them to surfaces. Examples include cork tiles, thin wood laminate, acrylic tiles, and paper stickers. Never cut these materials in the laser cutter if they have this backing. The glue will vaporize forming a coating on the lens that will coat it, cloud it, heat it, and then potentially crack the lens. The glue residue is worse than resin, and can't be removed without risking damage to the lens ... requiring a lens replacement.

Safe Materials

We only recommend the J Tech 2.8W laser for engraving/etching. This can be done on almost anything, including wood, cardboard, aluminum, stainless steel, some plastics, marble, stone, tile, and glass. Here is an example material list from J Tech to use as reference:

Material	Max thickness	Notes	WARNINGS!
Many woods	Engrave Only	Avoid oily/resinous woods	Be very careful about cutting oily woods, or very resinous woods as they also may catch fire.
Plywood/Composite woods	Engrave Only	These contain glue, and may not laser cut as well as solid wood. Plywood with "filler" will cut better than multiple boards of hardwood glued together. Check for the least dense plywood when shopping for this.	
MDF	Engrave Only	These are okay to engrave but are very hard to cut with our lasers. The glue in the mixture makes it very hard to cut so we recommend engraving only.	
Paper, card stock	thin	Cuts very well and also very quickly.	
Cardboard, carton	thicker	Cuts well but may catch fire.	Watch for fire.
Cork	1/8"	Thin cork can be cut, but the quality of the cut depends on the thickness and quality of the cork. Engineered cork has a lot of glue in it, and may not cut as well. This takes a lot of passes to get done.	Avoid cutting thicker cork (5mm). Engraves well, cuts poorly.
Acrylic/Lucite/Plexiglas/PMMA	1/8"	Cuts extremely well leaving a beautifully polished edge. Only can cut dark colors like black. Clear will not cut and light colors like white are hard or near impossible to cut. Takes a ton of passes depending on the thickness and color.	
Thin Polycarbonate Sheeting (<1mm)	Engrave Only	Very thin polycarbonate can be cut, but tends to discolor badly. Extremely thin sheets (0.5mm and less) may cut with yellowed/discolored edges.	Watch for smoking/burning
Delrin (POM)	Engrave Only	Delrin comes in a number of shore strengths (hardness) and the harder Delrin tends to work better. Great for gears!	
Kapton tape (Polyimide)	1/16"	Works well, in thin sheets and strips like tape.	
Mylar	1/16"	Works well if it's thin. Thick mylar has a tendency to warp, bubble, and curl	Gold coated mylar will not work.
Solid Styrene	1/16"	Smokes a lot when cut, but can be cut.	Keep it thin.
Depron foam	1/4"	Used a lot for hobby, RC aircraft, architectural models, and toys. 1/4" cuts nicely, with a smooth edge.	Must be constantly monitored.
Gator foam		Foam core gets burned and eaten away compared to the top and bottom hard paper shell.	Not a fantastic thing to cut, but it can be cut if watched.
Cloth/felt/hemp/cotton		They all cut well. Our lasers can be used in lace-making.	Not plastic coated or impregnated cloth!
Leather/Suede	Engrave Only	Leather is very hard to cut, but can be if it's thinner than a belt (call it 1/8"). Smells really bad when cut.	Real leather only! Not 'pleather' or other imitations .. they are made of PVC.
Magnetic Sheet		Cuts depending on the type. You need to get the "laserable" magnetic sheet from a proper supplier like Johnson Plastics.	
NON-CHLORINE-containing rubber		Fine for cutting.	Beware chlorine-containing rubber!
Teflon (PTFE)	thin	Cuts OK in thin sheets. See https://www.ulsinc.com/materials/teflon ; the issues listed in https://en.wikipedia.org/wiki/Polymer_fume_fever should not matter because our lasers are fully vented and exhausted.	
*Carbon fiber mats/weave			
that has not had epoxy applied"		Can be cut, very slowly.	You must not cut carbon fiber that has been coated!!
Coroplast ('corrugated plastic')	Engrave Only	Difficult because of the vertical strips. Three passes at 80% power, 7% speed, and it will be slightly connected still at the bottom from the vertical strips.	

