



MATERIAL: upcycled steel frame and live ZTISTA material – a blend of cellulose, clay, flax fiber, wood chips, biopolymer cover.

COLORS: 12 Ztista clors, semi-gloss GU 30.

A footrest may be painted in the color of the chair, but we recommend chrome plating.

The Ztista chair is monolithic. Its shape allows you to put one chair on top of another.

Please kindly note that handcrafted items may slightly differ in shades and textures.

Only for indoor use, outdoor is an option.

Mostly made to order. Lead time 8-10 weeks

DIMENSIONS: 840 x 450 x 490 mm

APPROXIMATE WEIGHT: 10 kg

PACKAGE: Cardboard box 700 x 700 x 1160 mm, 33 kg

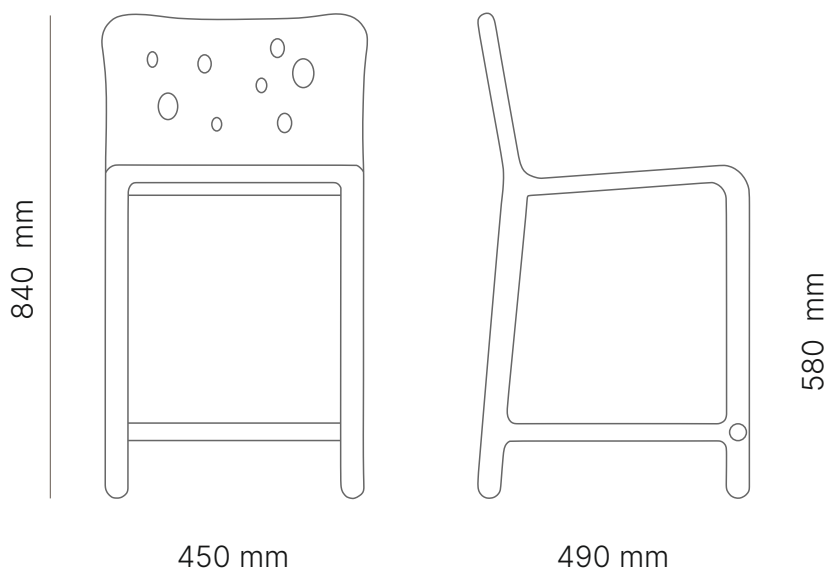



SYTINOK
RAL 5003



HMARA
RAL 5014



BURIAK
NCS S 6020-R



MOCHAR
RAL 9011



HLYNA
NCS S 4040-Y70R



PTAHA
NCS S 2005-Y60R



KORA
RAL 1019



ZILLIA
RAL 7002



HATKA
NCS S 0500 - N



DRIMOTA
NCS S 1002 - G



SONIAH
RAL 1013



DYMKA
NCS S 3502 - G

TRANSPORTATION AND STORAGE:

The product should be transported and stored in the package in compliance with safety precautions to avoid mechanical damage and exposure to atmospheric precipitation.

Aggressive shipping conditions via overseas cargo containers may cause condensation. In case you have noticed moisture on our ZTISTA product under the polyethylene it is necessary to remove the polyethylene carefully and leave the product in a warm and dry room for 24-48 hours without mechanical stress. Don't worry about traces of paint on your hands, it will dry out and stabilize in 24-48 hours.

PRODUCT RECEIVING RULES:

Carefully inspect the product at the courier who delivered it. Pay attention to the configuration, the quality of the appearance of the product, the effect of transformation mechanisms (if any). Remember that accepting a product without specifying any flaws that may be detected when purchasing the product (visible flaws) will deprive you of the right to refer to them in the future. Only after inspection sign the act of acceptance of goods.

ALLOWED AND ARE NOT THE DISADVANTAGES:

- slight (within 10%) difference between the form and the photo of products. All of the ZTISTA items are created by craftsmen manually;
- slight (within 10%) color difference from photos.

RULES FOR OPERATION OF ZTISTA PRODUCTS:

It is not allowed to place ZTISTA products in damp, not ventilated rooms. The optimal operating conditions for product are warm, dry, ventilated rooms with a temperature of 18-25 ° and relative humidity of 40-65%. Do not place ZTISTA products in places in the immediate vicinity of the heating system. Direct sunlight may force 10% color fading in 3 years. Do not place hot objects or sharp-edged objects on the surface. Protect surfaces from mechanical damage, from solvents, alkalis and acids, as well as fats.

Keep away from acetone, solvents and other chemical and cleaning agents. ZTISTA products should be protected from various mechanical shocks. Do not place wet, cold, or hot objects on the surface of the product this can lead to stains on the surface.

We advise you to observe the product care rules specified in the warranty, in the passport and in the operating instructions.

We advise you to comply with safety rules when folding transformation mechanisms.

It is not allowed to exert great efforts during the transformation of sliding and transformed elements of products.

Do not expose ZTISTA products to unusual loads. The load on the ZTISTA products should be distributed evenly and not exceed the permissible norm.

Maximum load 100 kg.

DUST: Remove with a dry soft cloth (i.e. cotton).

STAINS: Remove with a soft cloth with mild soap water. Wipe gently with a dry soft cloth. Local contaminants (stains) must be removed immediately, not allowing them to dry. Do not try to scrub dried spots.

Do not use detergents or abrasive powders. It is likely that they will enter into a chemical reaction or scratch the lacquer coating. Damage to the lacquer coating is possible from the use of such products, which will lead to accelerated ageing and loss of initial appearance! When buying cleaning and care products for ZTISTA product, pay attention to the composition of the products.

WARRANTY:

The warranty period for the operation of products is 12 months and is calculated from the date of sale specified in the warranty card, and in the absence thereof from the date of shipment from the warehouse.

Free maintenance (product repair) occurs during the warranty period, subject to the conditions of transportation, operation and recommendations for the care of the product.

Free warranty repair applies to product defects arising from the fault of the manufacturer.

Insufficiencies in the work performed that can be detected upon receipt of the product (claims regarding the appearance of the product, lack of completeness, as well as inconsistencies in the order, etc.) are accepted only upon receipt of the product and provided that the unpacking was carried out by courier. In the future, such claims are not accepted, all work is carried out only at the expense of the buyer.

TERMS AND CONDITIONS OF DISCLAIMER:

The manufacturer reserves the right to refuse warranty repair and maintenance and qualify it as paid in the following cases: in the absence of this passport for the product.

Attention! In case of loss, the passport is not restored; on product with visible defects at the time of purchase, which should have been noticed by the consumer; product with defects that arose due to the fault of the consumer, due to damage from loads exceeding the established norms; if product defects have arisen as a result of a consumer's violation of the operating rules and care recommendations; damage to the product and its loss as a result of natural factors (fires, floods, earthquakes, accidents, etc.); if the product has mechanical damage that occurred during improper use; if the product has damage to the inside of the product of unsuitable objects, liquids, animals, insects, has scratches and stains on the surface resulting from a careless attitude and improper care during operation; if damaged in deliberate or erroneous actions of the consumer; if the product was used not in accordance with the requirements of the instructions for assembly and operation; damage to the product as a result of changes in its design.

NOTE! CLAIMS ON CONTAMINATION OF THE PRODUCT DUE TO OPERATION ARE NOT ACCEPTED.

CARE INSTRUCTIONS:



PROCEDURE FOR CLAIMS SUBMISSION:

Claims on the appearance of the product, the incompleteness of the set are accepted only directly upon receipt of the product. Further in future, such claims are not accepted, all work is carried out only at the expense of the buyer.

Claims for the quality and completeness of product should be sent by the buyer to the store where the product was purchased. Free and paid service is carried out at the written request of the buyer.

The term of repair and satisfaction of the buyer's requirements corresponds to the period specified in the law "On Protection of Consumer Rights". By agreement of the parties, this period may be extended.

The nature of the defect is established by a company specialist. Based on the results of the inspection, he draws up an act of inspection of the product and introduces the buyer to it. Repair is carried out at home or at the enterprise, depending on the nature of the defect.

Claims shall not be accepted in case of defects arising due to non-compliance by the buyer with the rules of transportation, storage, operation, and maintenance of the product.

TERMS AND CONDITIONS OF ADDITIONAL SERVICE:

Product with defects that arose due to the fault of the Buyer due to breakdowns, breaks from excessive loads, can be restored and/or repaired at the Buyer's expense.

After the warranty period, the manufacturer provides after-sales service at the buyer's expense.

REPAIR MANUAL FOR ZTISTA PRODUCTS:

All ZTISTA products are supplied with appropriate color water-based acrylic paint to have a possibility to make small repairing of non-deep scratches and defects.

Please read the repairing manual for restoration of ZTISTA products.

All ZTISTA products are supplied with appropriate color water-based acrylic paint to have a possibility to make small repairing of non-deep scratches and defects.





No harmful vapours are released, and additional ventilation is not required.

Paint may be applied only at temperatures between **5°C** and **35°C**.



1. If the damage is minor (scratches) they can be painted.

To do this, take:

- ear stic; 
- toothpick; 
- a brush; 
- a small tampon; 

1.1. Surfaces must be **clean** and **dry**.

Contaminants such as dirt, dust, grease, wax, oil, soap film, bond breakers and curing compounds must be removed before application.



1.2. Mix the paint thoroughly before use. Easily soak a brush or etc. in the paint and apply first coat over the scratch.
Wait **1 hour** and re-apply. Low temperature, high humidity, thick films or poor ventilation will increase these dry time. After two layers we recommend to leave the product for **12 hours** to dry properly. Dry Time Based on **25°C, 50% RH;**



Dry Time: **Touch - 20 Minutes;**



Recoat – **1 hour;**

2. If the damage is more significant (cracks, splits, broken structure). You need to prepare a flour and water mixture and fill the crack with it.
In a small container ≈100 g pour a teaspoon of PVA glue.
Add a teaspoon of flour to PVA glue.

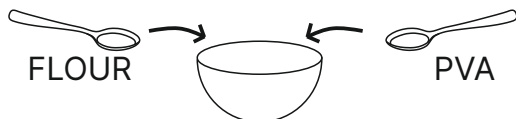

2.1. Add gradually and mix thoroughly until there are no lumps. You need to get smooth, flexible like plasticine structure.



2.2. Fill the crack with the mixture.

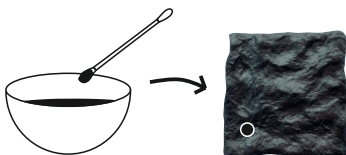

2.3. Wait **20 minutes** for self-drying or dry with warm air at a distance of **10 cm** for **5 minutes**.



SELF-DRYING

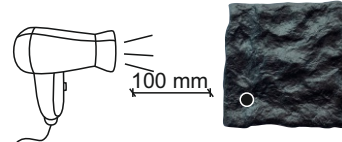
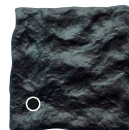

USING A HAIR DRYER



2.4. Paint the restored place as shown in **paragraph 1**.

Scan the QR code to watch detailed video instruction

