

**Shower Valve**

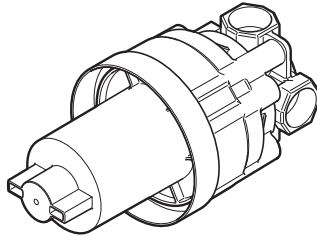

**TBN01101U / TBN01103U**

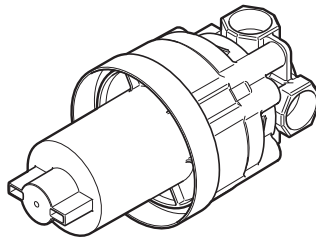

**TBN01102U**

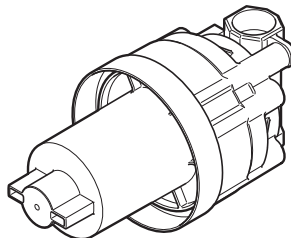

**TBN01104U**

**Warranty Registration and Inquiry**

For product warranty registration, TOTO U.S.A. Inc. recommends online warranty registration. Please visit our web site <http://www.totousa.com>. If you have questions regarding warranty policy or coverage, please contact TOTO U.S.A. Inc., Customer Service Department, 1155 Southern Road, Morrow, GA 30260 (888) 295-8134 or (678) 466-1300 when calling from outside of U.S.A.

## TABLE OF CONTENTS

Thank you for Choosing TOTO!.....	2	Included parts.....	3
Care and Cleaning.....	2	Installation Procedure.....	4
Warnings.....	2	Warranty.....	7
Before Installation.....	2	Rough-in dimensions.....	26
Tools you will need.....	3		

## THANK YOU FOR CHOOSING TOTO!

The mission of TOTO is to provide the world with healthy, hygienic and more comfortable lifestyles. We design every product with the balance of form and function as a guiding principle. Congratulations on your choice.

## CARE AND CLEANING

Your new shower is designed for years of trouble-free performance. Keep it looking new by cleaning it periodically with mild soap, rinsing thoroughly with warm water and drying with a clean, soft cloth. Do not use abrasive cleaners, steel wool or harsh chemicals, as these will dull the finish. Failure to follow these instructions may void your warranty.

## WARNINGS

For safe operation of the faucet, please observe the following:

- Operating Pressure:
  - Minimum Pressure.....20 psi (138 kPa), dynamic
  - Maximum Pressure.....80 psi (551 kPa), static
- Do not solder the connections directly to the valve as damage to the internal components may occur.
- Do not use this product at an ambient temperature below 32°F (0°C).

## BEFORE INSTALLATION

- Observe all local plumbing codes.
- Before installing the shower, be sure to thoroughly flush the supply pipes of dirt and debris.
- Make sure the water supply is shut off at the stop valve.
- Read these instructions carefully to ensure proper installation.
- TOTO reserves the right to update product design without notice.

## TOOLS YOU WILL NEED

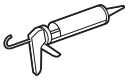

Silicone caulk



Hacksaw

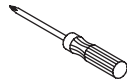

Screwdriver



Adhesive caulk



Screw

## INCLUDED PARTS

- Check to make sure you have the following parts indicated below:

Valve with Plaster Guard

**TBN01101U / TBN01103U**

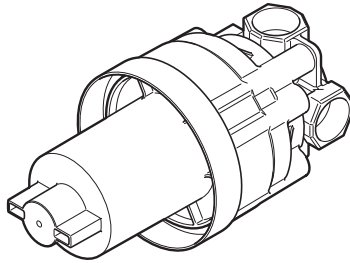

**TBN01102U**

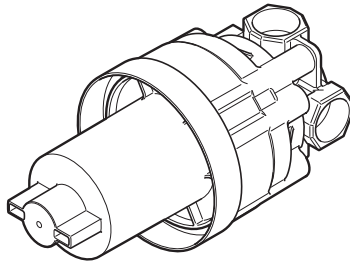

**TBN01104U**

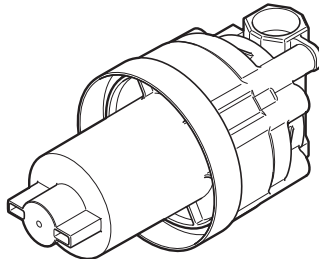

# INSTALLATION PROCEDURE

ENGLISH

## I. Preparing the installation area

1. Conduct cleaning and pressure test to the COLD and HOT water supply pipelines.
2. Connect the water inlet and outlet pipes to the main body part as shown below.

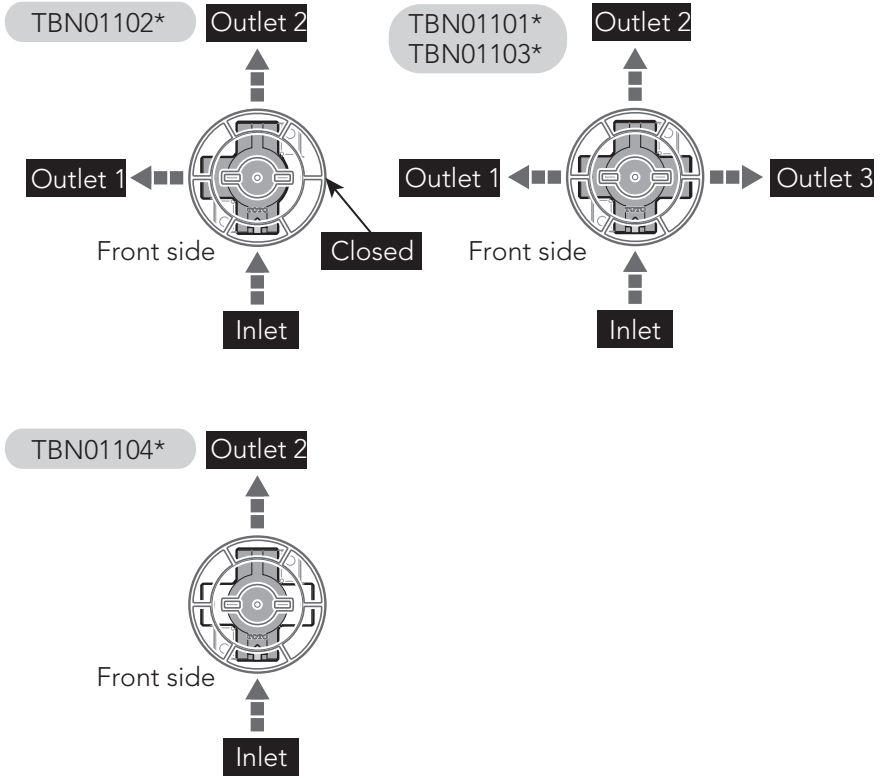

# INSTALLATION PROCEDURE

## II. Installation of Valve

1. Remove the inner plaster guard before installing the valve.
2. Use self-tapping screws below  $\varnothing 0.2''$  ( $\varnothing 5\text{mm}$ ) diameter to secure main body part to the wall. The valve needs to be perpendicular to the wall surface.

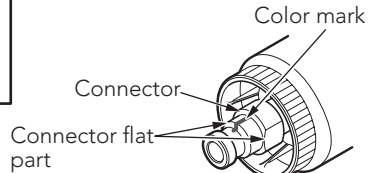
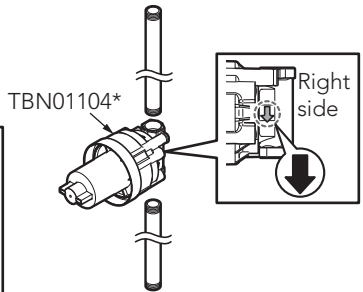
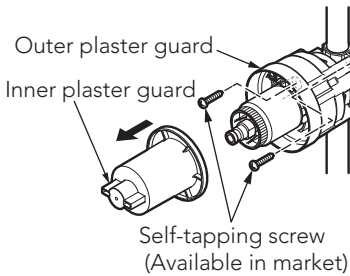
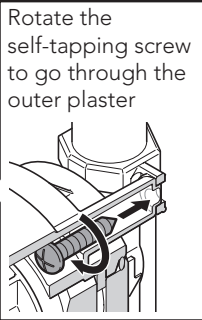
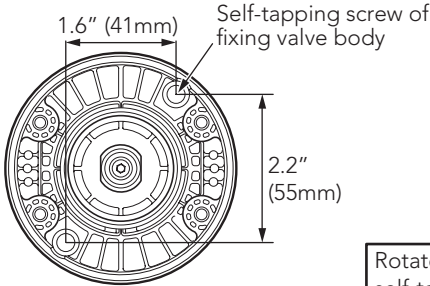
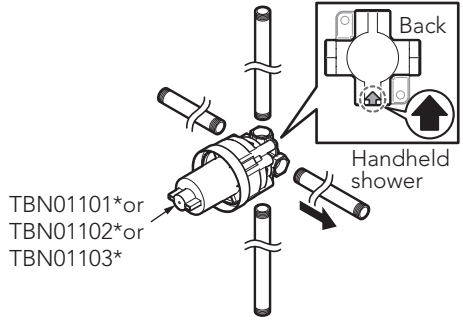

3. After installing the valve, verify the connector color mark is facing "up", then install the inner plaster guard onto the valve. The flat part of the inner plaster guard should align with the flat part of the connector.

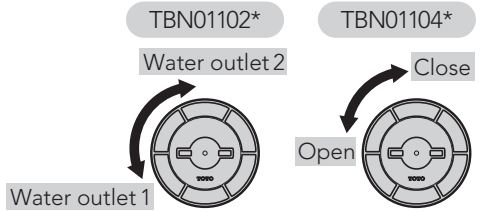

4. After installation, open the shut-off valve. Rotate the inner plaster guard to confirm the water outlet direction as shown in the figure.

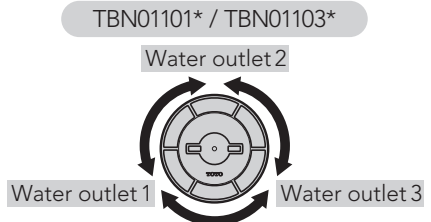

# INSTALLATION PROCEDURE

5. Install the inner plaster guard in the valve and complete wall surface.

## WARNING:

- DO NOT REMOVE the inner plaster guard when installing the valve.
- BE AWARE of burial depth of the valve during installation.
- VERIFY that during installation, the wall surface is located between the MIN and MAX marks on the plaster guard.
- CORRECT dimension for the wall surface hole is:  $\text{Ø}3\text{-}9/16\text{''} \sim 3\text{-}3/4\text{''}$  ( $\text{Ø}90 \sim 95\text{mm}$ ).
- CONFIRM there is no water leakage from the water inlet pipe after connecting to valve and before completing the wall.

6. Apply a coat of silicon caulk at the gap between the plaster guard and the wall surface.
7. Apply a coat of waterproof caulk on the wall surface and use a scraper to scrape it flat with the wall. Adhere the vapor barrier onto the wall surface (The vapor barrier should be firmly compacted and kept close to the wall surface).
8. Apply another coat of waterproof caulk on the vapor barrier and use a scraper to scrape flat. After the waterproof caulk becomes dry, complete construction of the wall surface.

## WARNING:

Please ensure the gap between the wall surface and the plaster guard is within  $3/16\text{''}$  (5mm).

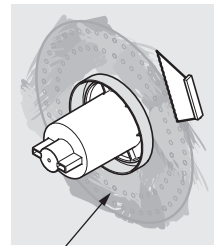
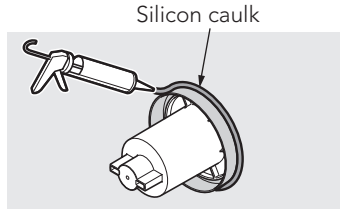
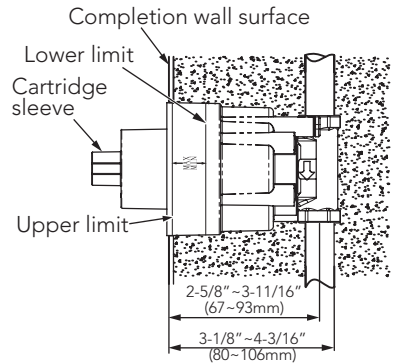

Adhesive caulk

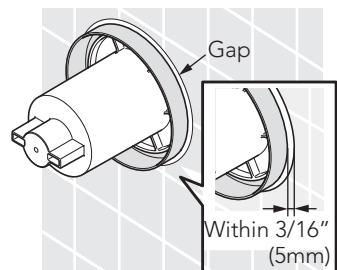

## TABLA DE CONTENIDO

¡Gracias por elegir TOTO!.....	8	Piezas Incluidas.....	9
Cuidado y Limpieza.....	8	Procedimiento de Instalación.....	10
Advertencias.....	8	Garantía.....	13
Antes de la Instalación.....	8	Dimensiones Preliminares.....	26
Herramientas que va a Necesitar.....	9		

## ¡GRACIAS POR ELEGIR TOTO!

La misión de TOTO es proporcionar al mundo estilos de vida saludables, higiénicos y más cómodos. Diseñamos cada producto con el equilibrio de forma y función como principio rector. Felicidades por tu elección.

## CUIDADO Y LIMPIEZA

Su nueva ducha está diseñada para años de rendimiento sin problemas. Mantenga su aspecto como nuevo limpiando periódicamente con jabón suave, enjuague bien con agua tibia y seque con un paño limpio y suave. No use limpiadores abrasivos, lana de acero o productos químicos agresivos, ya que éstos opacarán el acabado. El incumplimiento de estas instrucciones puede anular la garantía

## ADVERTENCIAS

Para un funcionamiento seguro del grifo, tenga en cuenta lo siguiente:

- Presión operacional:
  - Presión mínima ..... 20 psi (138 kPa), dinámica
  - Presión máxima ..... 80 psi (551 kPa), estático
- No suelde las conexiones directamente en la válvula, ya que podría ocasionar daños a los componentes internos.
- No use el producto a una temperatura ambiente inferior a 32° F (0° C)

## ANTES DE LA INSTALACIÓN

- Observe todos los códigos de plomería locales.
- Antes de instalar la ducha, asegúrese de enjuagar a fondo los tubos de suministro de suciedad y residuos.
- Asegúrese de que el suministro de agua esté cerrado en la válvula de cierre.
- Lea estas instrucciones cuidadosamente para asegurar una instalación correcta.
- TOTO se reserva el derecho de actualizar el diseño del producto sin previo aviso.

## HERRAMIENTAS QUE VA A NECESITAR

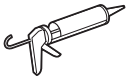

Sellador de  
silicona



Sierra para  
metales

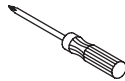

Destornillador



Masilla adhesiva



Tornillos

## PIEZAS INCLUIDAS

- Verifique para asegurarse de tener las piezas que se indican a continuación:

Valvula con protector de yeso

**TBN01101U / TBN01103U**

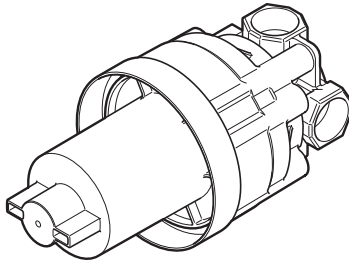

**TBN01102U**

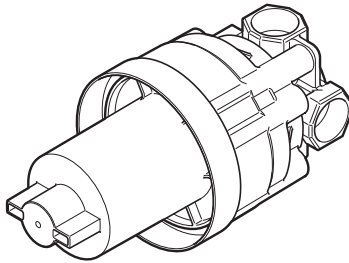

**TBN01104U**

