

BLISS BSL60S

Sink: BSL60SSINK

Dimensions:	width	depth	height
inches	59"	18.5"	23.75"
mm	1499	470	603

NOTE: DIMENSIONS AND TECHNICAL DETAILS ARE SUBJECT TO CHANGE WITHOUT NOTICE

. FRONT ELEVATION

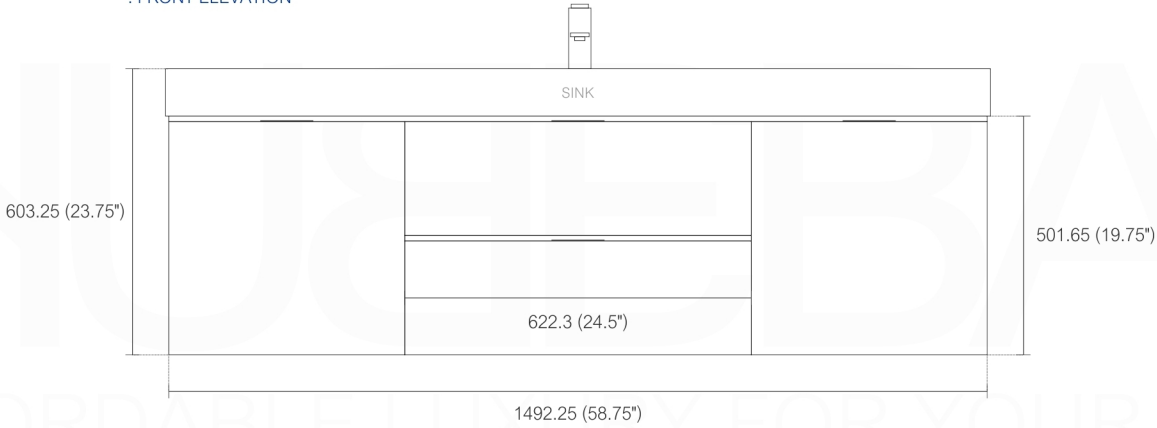

. BACK ELEVATION

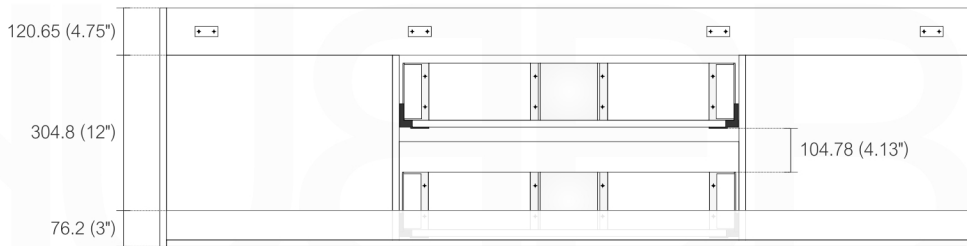

. TOP ELEVATION

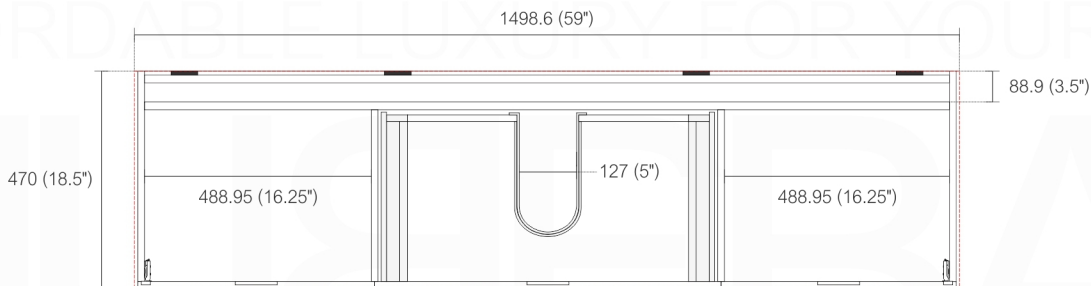

. Adjustments

The options for height adjustment depend on the type of base plate. All adjustments can be made independent of one another.

For depth adjustment, select base plates have worm gear adjustment access through the hinge arm.

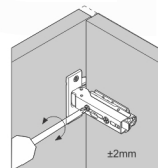

Side adjustment

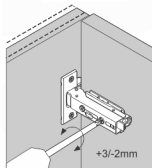

Depth adjustment via worm gear

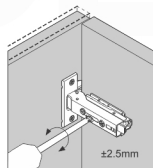

Height adjustment via base plate

. Reveal

The reveal (R) is the distance required between two doors or between the door and side wall of the cabinet to allow sufficient space for opening the door. The required reveal width (R) depends on the thickness of the door.

Most cabinet makers prefer a reveal (R) of between 3mm and 6mm.

Full Overlay/Overlay Door

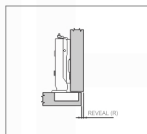

Half Overlay Door

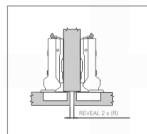

Inset Door

