

# VOVO STYLEMENT Install Guide

Easily install the WATERJET bidet by yourself!

**Note:** Before the installation, please check the size of your toilet using the template first.

## 1 Separate water supply hose

- Turn the water supply valve clockwise to lock, and separate the toilet hose using a spanner

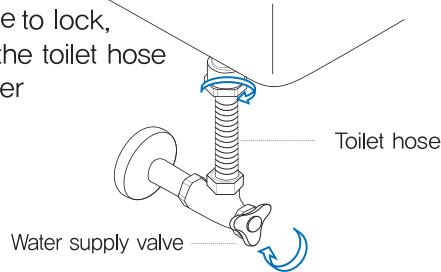

## 2 Connect the T-valve to the toilet and toilet hose

- Place the T-valve between the toilet and the toilet hose

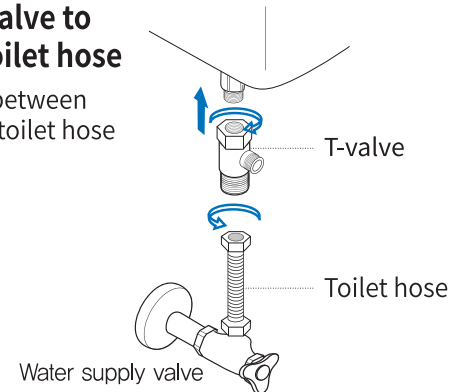

## 3 Remove the existing toilet seat.

- Unfasten the nut and remove the toilet seat,
- Save the old toilet seat lid and nuts for reinstallation later.
- Place the template on the toilet after removing the toilet seat cover.

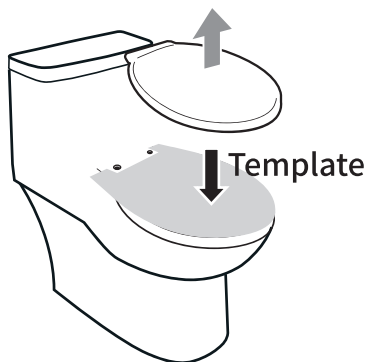

## 4 Install the base bracket.

- Place the fixing bolt on the base bracket.
- Align the front of the bidet body and the front of the toilet before fastening the nuts.

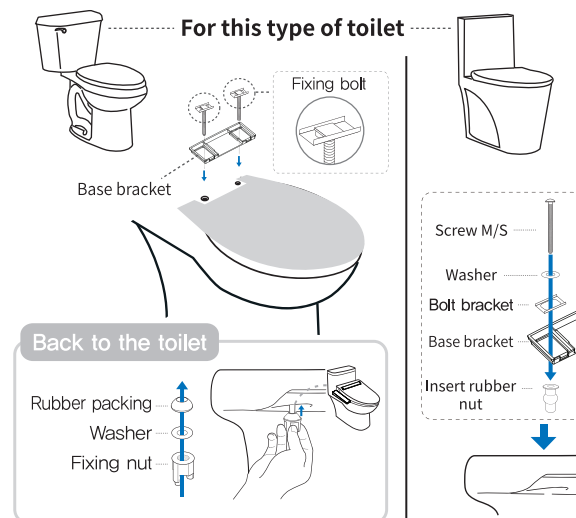

## 5 Install the bidet and secure the remote control holder

- Slide the bidet and install it.

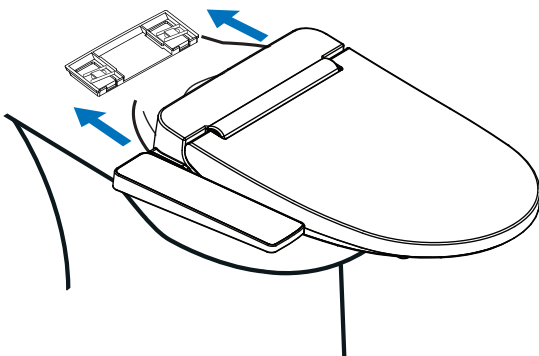

- Secure the remote control holder to the wall with screws or peel off the double-sided tape sticker on the back of the remote

## 6 Connect the hose and turn on the water

- Connect the hose to the T-valve and the bidet.
- Turn the water supply valve counterclockwise to allow water flow.
- Connect the outlet.

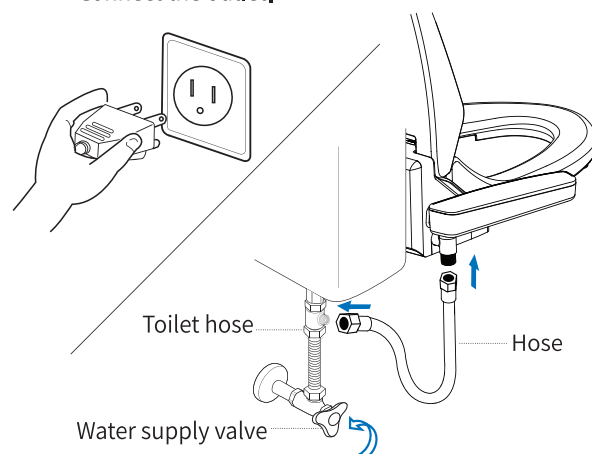

# How to use

VB-5000SE  
VB-5100SR

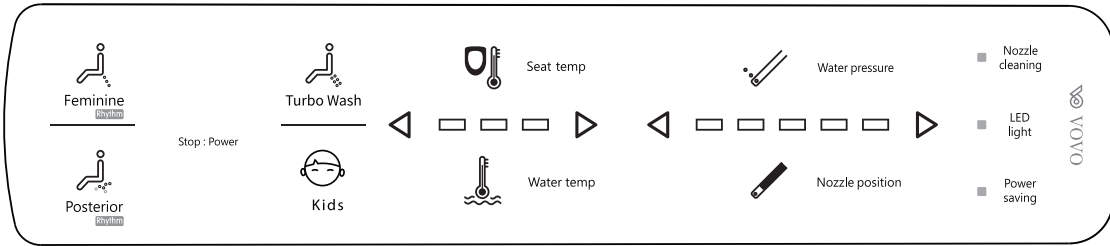

VB-3000S  
VB-3100S

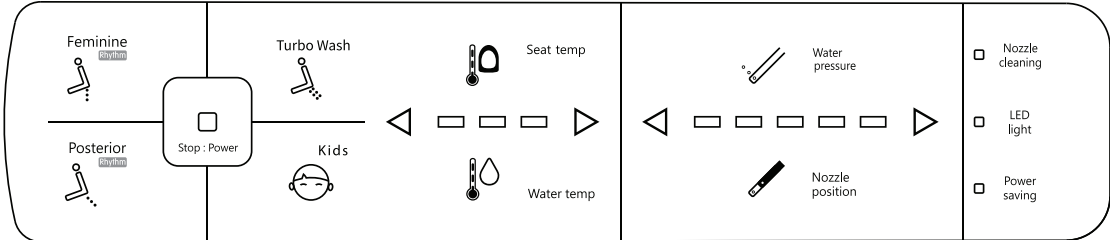

## STOP:POWER

- Press the Stop button when you want to stop the function.
- When you press the Stop button for more than 3 seconds, the power will turn off. Press the Stop button again, the power will turn on.

## Dry

(VB-6000SE, VB-6100SR, VB-4000S, VB-4100S)

- Use this after using wash function
- Wipe off the water with toilet paper before using dry function for pleasant using.

## Kids

(VB-5000SE, VB-5100SR, VB-3000S, VB-3100S)

- Water position and nozzle pressure is set for kids use.
- Nozzle position would be set to 5th level(High) and water pressure would be set to 1st level(Low)

## Water Pressure and Nozzle Position Adjustment

- Water pressure and nozzle position can be adjusted in 5 levels.

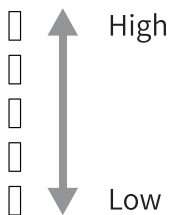

VB-6000SE  
VB-6100SR

VB-4000S  
VB-4100S

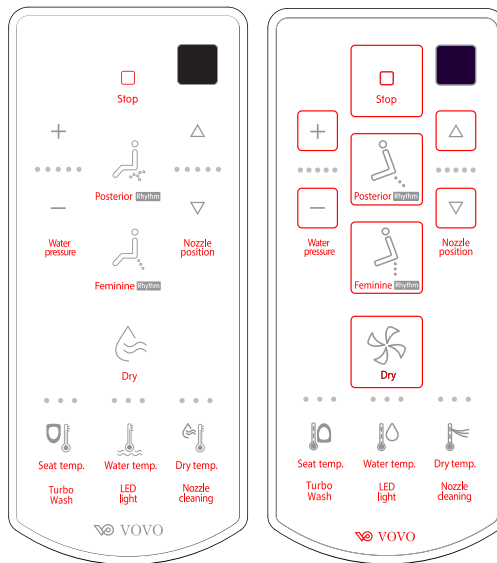

## Posterior/Rhythm

- Press Posterior/Rhythm button, to operate washing function.
- Press Posterior/Rhythm button again during using this function. Rhythm(Pulsating) function will work.

## Feminine/Rhythm

- Press Feminine/Rhythm button, to operate Feminine function.
- Press Feminine/Rhythm button again when during using this function, Rhythm(Pulsating) function will work.

## Turbo Wash

- Press Turbo button, Turbo wash will operate.
- It starts from the lowest water pressure.

## Water Temperature, Seat Temperature, Dry Temperature

- 3 levels of Water Temperature / Seat Temperature / Dry Temperature

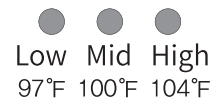

## Nozzle Cleaning

- You can clean the nozzle by pressing the Nozzle cleaning button.

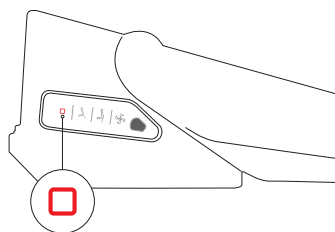

## Power Saving

Press the STOP button once on the side control panel of the product without seating to operate power save mode. Press the STOP button once more without seating to turn off the power save mode.

## LED Light

The LED lamps illuminate the toilet bowl with a warm glow.