

- Prior to installation please check received items against the "Packing List". Please report any missing items to your retailer immediately.
- Protect all surfaces from sharp objects, high heat sources, direct prolonged sunlight and chemical hazards.
- Professional installation recommended.

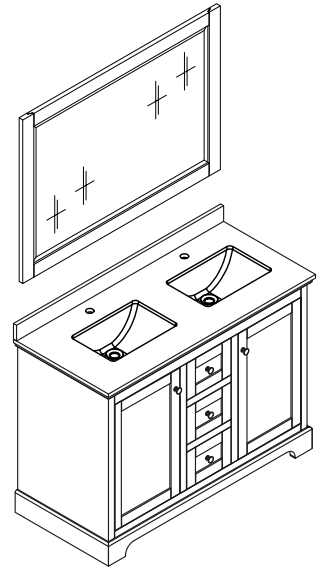

PACKING LIST

(Not all components may be included, depending upon your purchase)

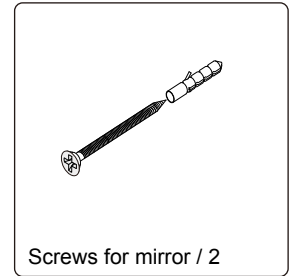
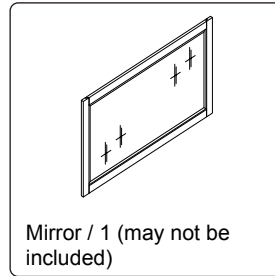
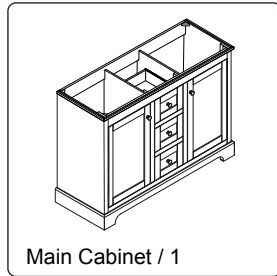
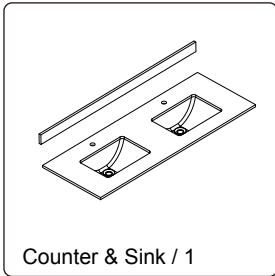

HOW TO ADJUST HINGES (if required)

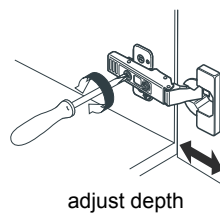
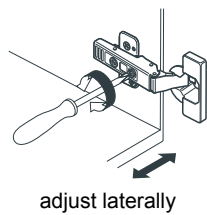
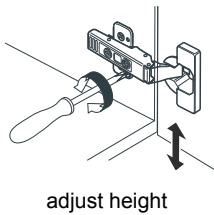

REQUIRED TOOLS NOT IN BOX

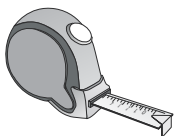

Tape measure



Pencil



Electric Drill

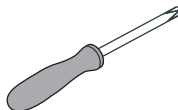

Phillips Screwdriver

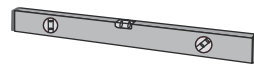

Spirit Level



Silicone sealant

INSTALLATION INSTRUCTIONS

