



ZLINE



BATH ACCESSORIES

Installation Guide
and Users Manual



This product can expose you to chemicals including nickel, which is known to the State of California to cause cancer, and birth defects or other reproductive harm. For more information go to www.P65Warnings.ca.gov.

Even though the materials used in all ZLINE Kitchen and Bath products conform to all federal government regulations and all national product standards, California's Prop 65 requires all businesses to provide a "clear and reasonable warning" if one or more listed chemicals may be present in the product, even if that chemical is present in trace quantities



Professionally design your home with ZLINE's Designer Kitchen and Bath Accessories. With a wide selection of accessories available, you can perfectly customize your kitchen and bath space to your style. The ZLINE Kitchen and Bath Accessories come in our specialty Chrome, Brushed Nickel, Gun Metal, Matte Black, and Polished Gold finishes for you to expertly coordinate and complete your kitchen and bath collection. With industry-leading resistance to wear, corrosion, and tarnish, the premium finishes on our kitchen and bath accessories are designed to shine and built to last.

Robe Hook

Tools:

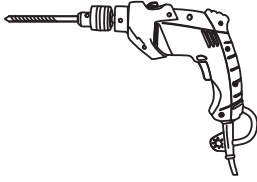

Drill

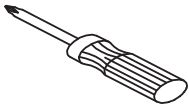

Phillips-head screwdriver

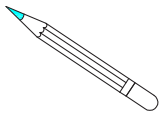

Pencil

Robe Hook

ELD-HK

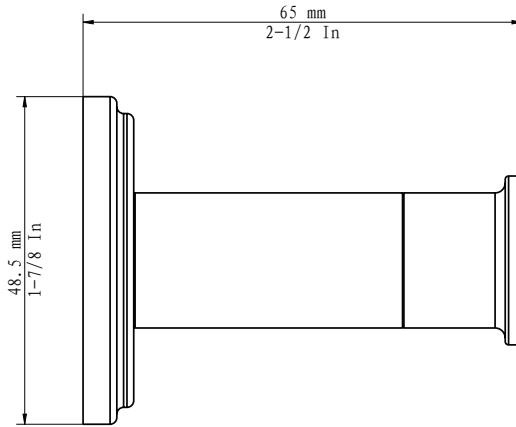

EMBY-HK

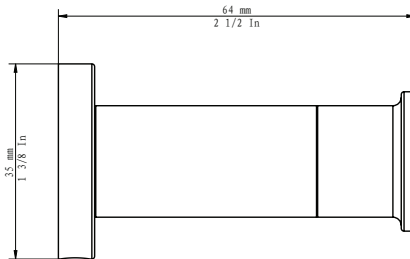

ROBE HOOK

BLS-HK

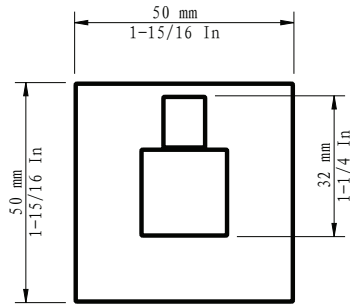

CBY-HK

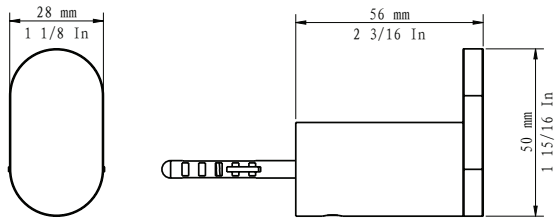

Robe Hook

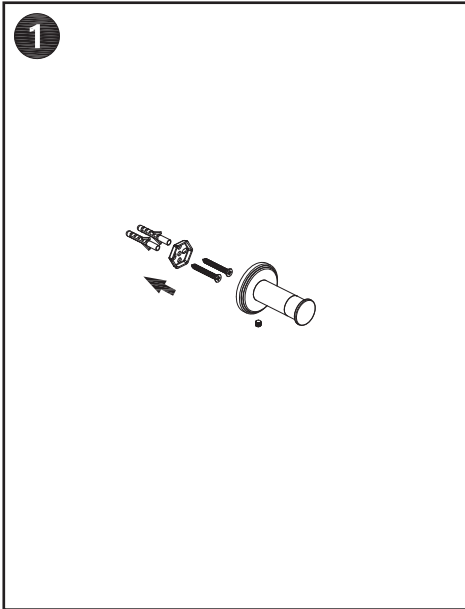

Plan where the robe hook will hang on the wall.

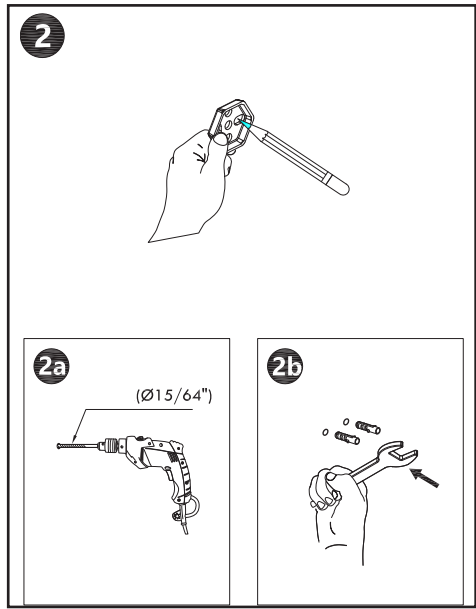

Use the drilling template and level to set the position.

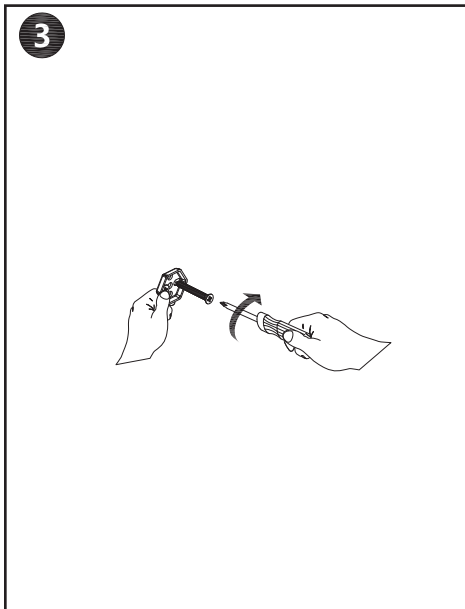

Secure the mounting plates into place.

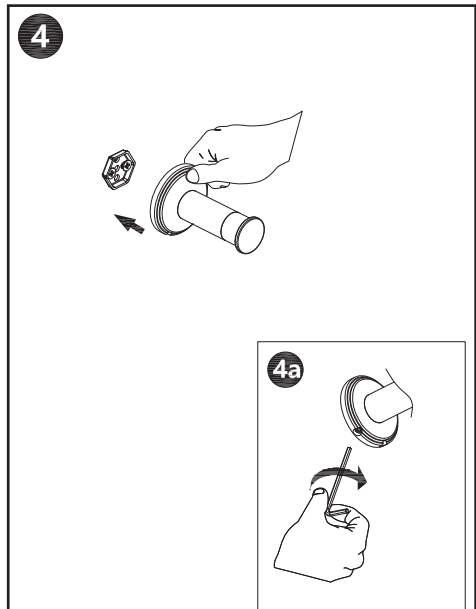

Secure the robe hook into place with the hex key.