

ANZZI™

Perfection is our Tradition™

LS-AZ074
LS-AZ8119

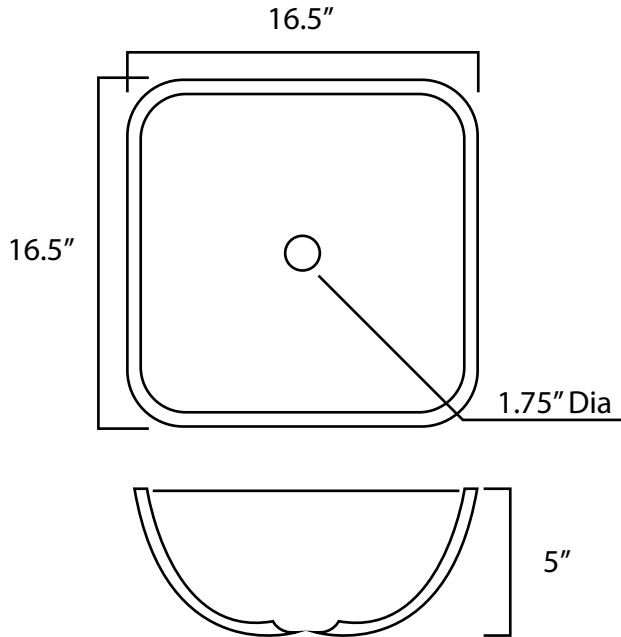

ANZZI VESSEL SINK DIMENSIONS

Measurements are approximate and subject to change.