

SVANGE 8442DLLRR LED Medicine Cabinet - Specification Sheet

Features

- Dimmable LED task lighting
- Integrated touch sensor control with memory
- Energy efficient LED lighting 5000K
- 900 Lumens
- CRI 90+
- Integrated Defogger



Construction

- Quality polished edge mirror
- Single phase wire installation
- 5 MM Silver Backed Copper Free
- Installation Either Surface Mount
- (Side Mirror Trim Panels included) or Recessed
- Includes installation hardware

Codes/Standards Applicable

- Conforms to UL Std. 962
- Cert. to CSA Std. C22.2 No.250.0-08
- ETL Intertek 5004931

Electrical System

- 120Vac, 60Hz, 55W
- Electric Current: 0.45A
- Wattage: 55W

Model

- SVANGE 8442DLLRR Swinging Doors
- Included models in this configuration:
Cabinet 1=2442L Cabinet 2=1842L
Cabinet 3=1842R Cabinet 4=2442R

Electrical System

- Performance Requirements: Contains the required
- Supervisory Circuit with the Auto-Monitoring Function as noted by UL 1310
- Input Voltage: Min 112Vac, Nom 125Vac, Max 137Vac
- Frequency: 60Hz
- Front Receptacle Current: 102-132Vac Nominal 15A
- USB Output Current: 5VDC Nominal 4A

CABINET CONFIGURATION

- Included models in this configuration:
Cabinet 1 = 2442L Cabinet 2=1842L Cabinet 3=1842R Cabinet 4=2442R

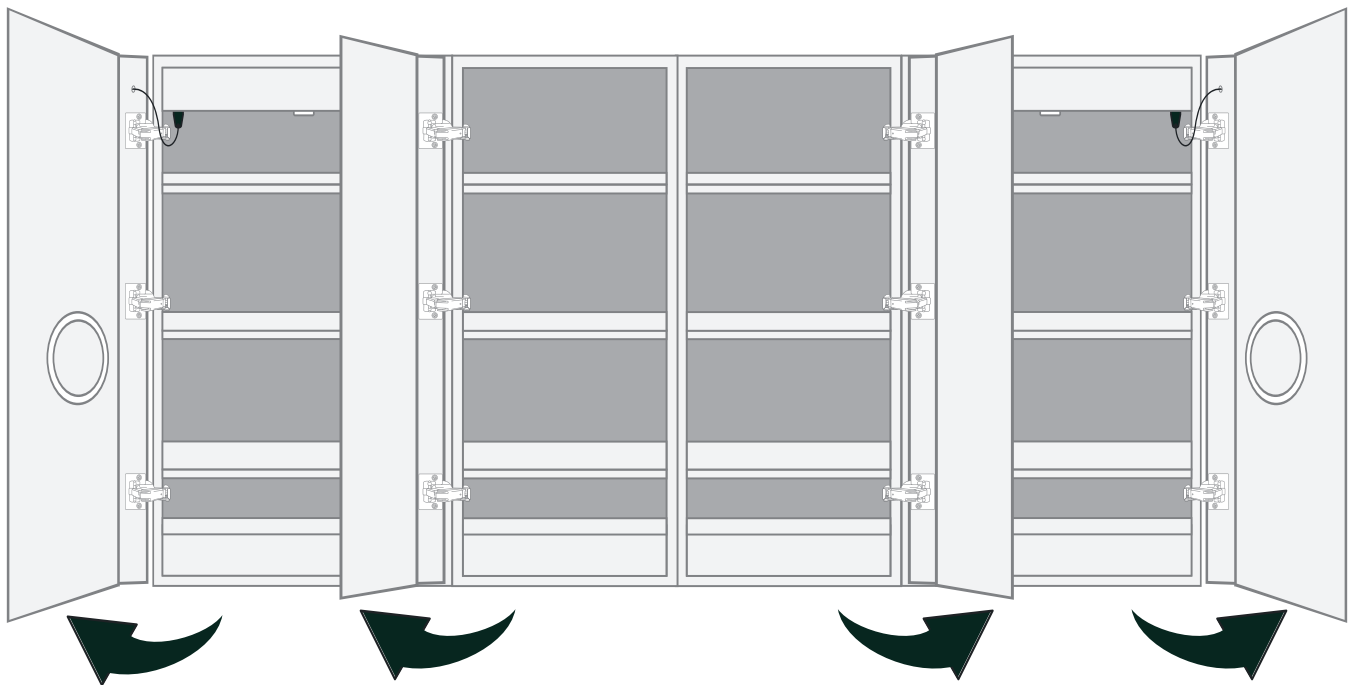
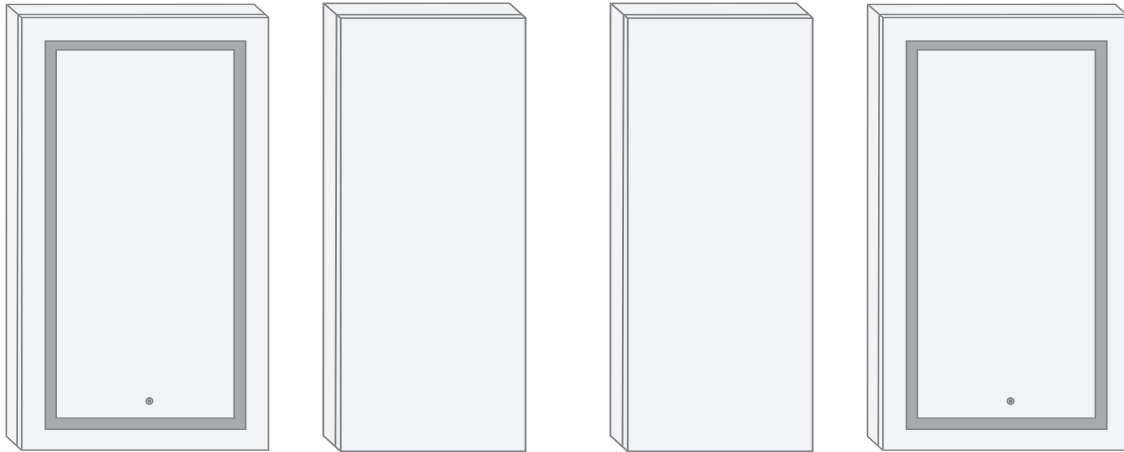

SVANGE 8442DLLRR LED Medicine Cabinet - Specification Sheet

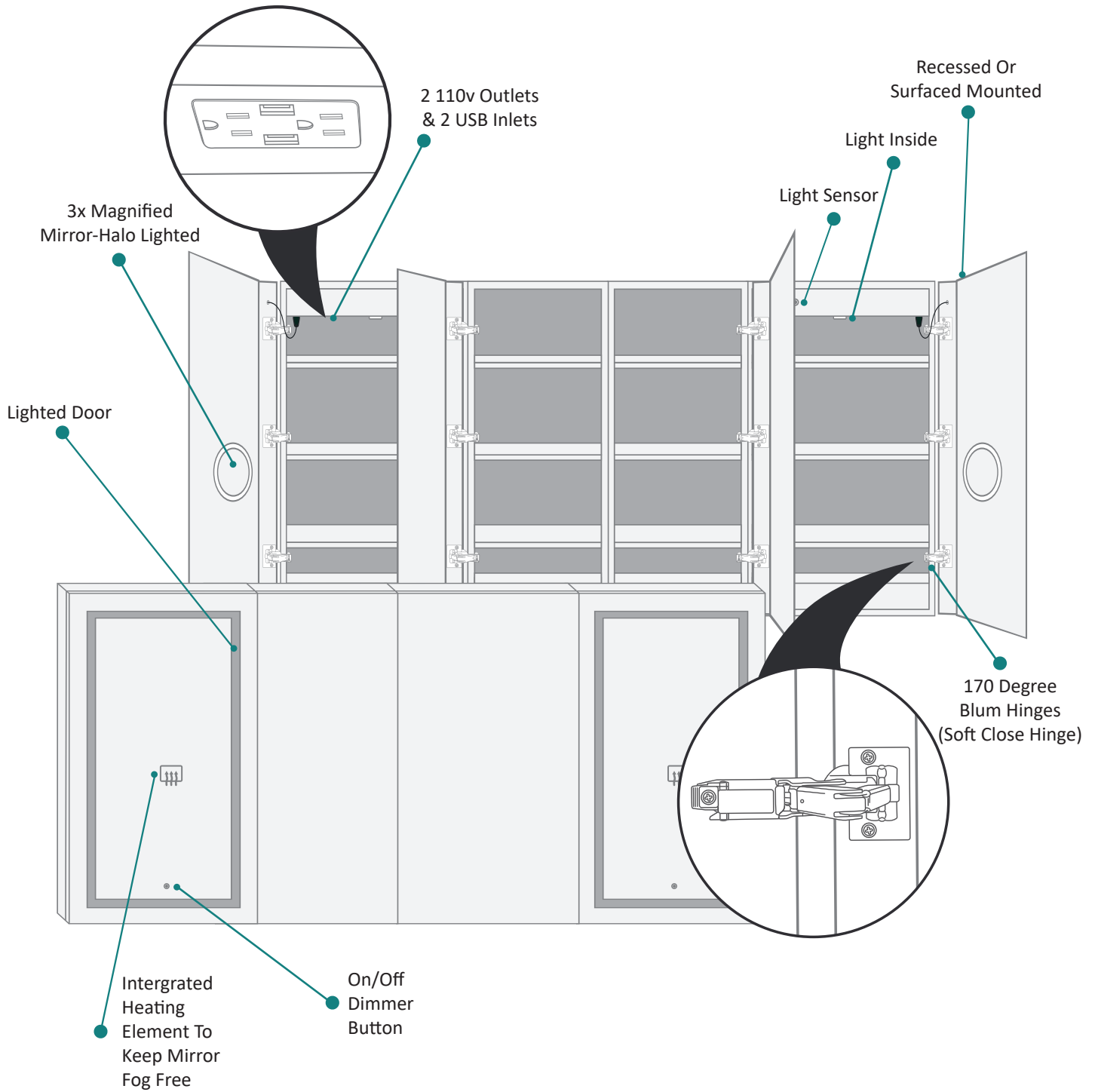

SURFACE MOUNT

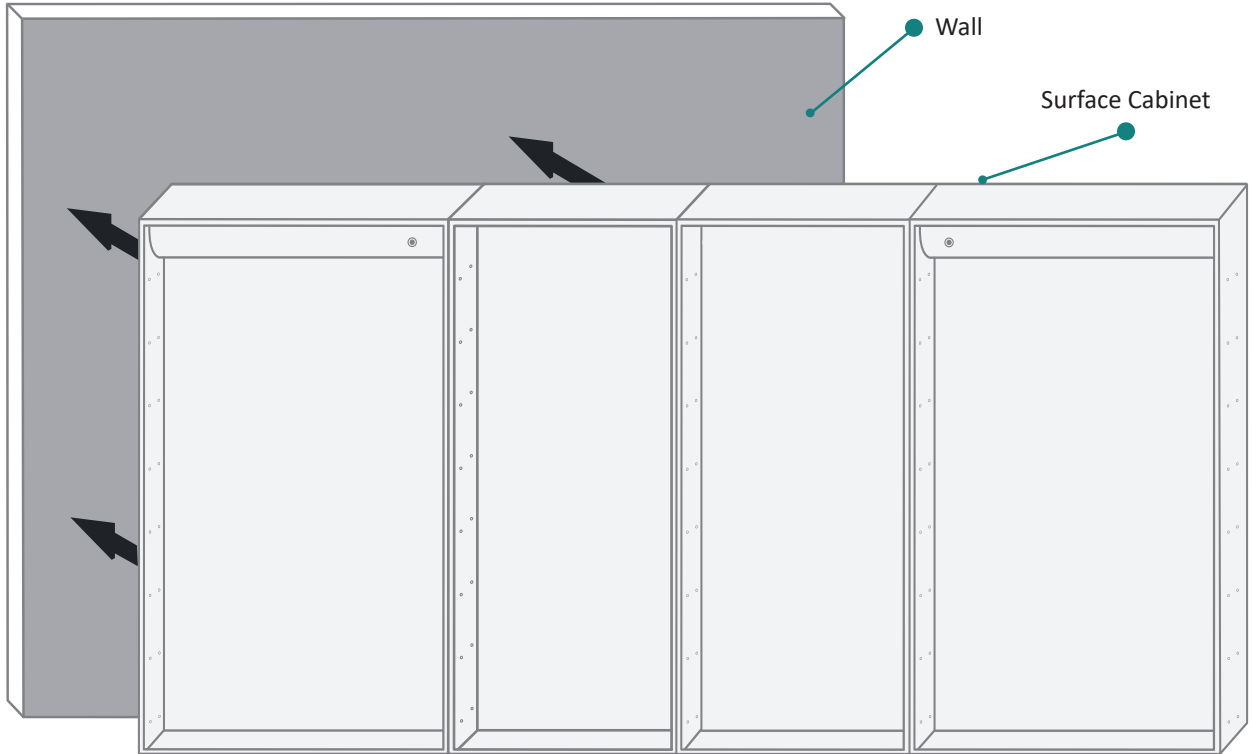

FRONT

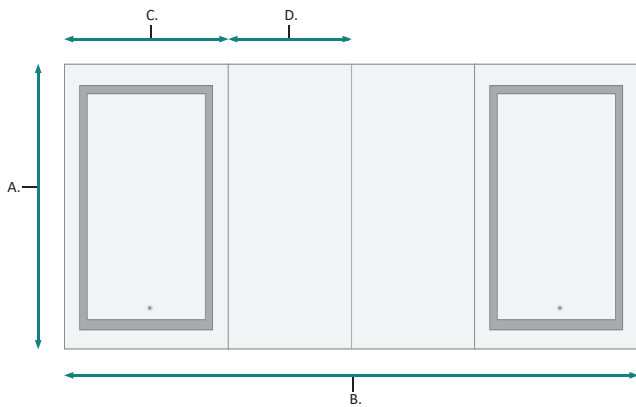

BACK

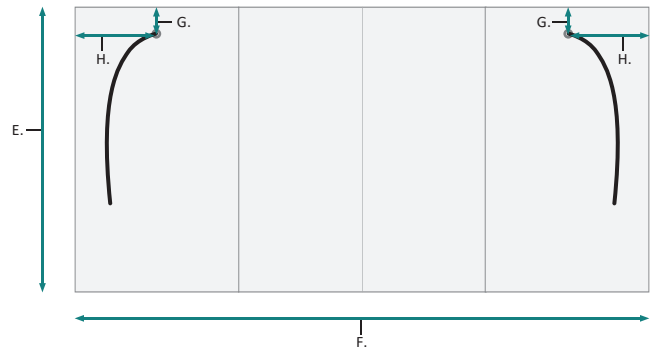

FRONT & BACKS

MODEL	A	B	C	D	E	F	G	H
SVANGE8442DLLRR	42	84	24	18	40-1/2	78	1-1/8	11-1/4

These measurements are for reference, for best results we suggest you measure actual product as small variations in size are possible

RECESSED MOUNT

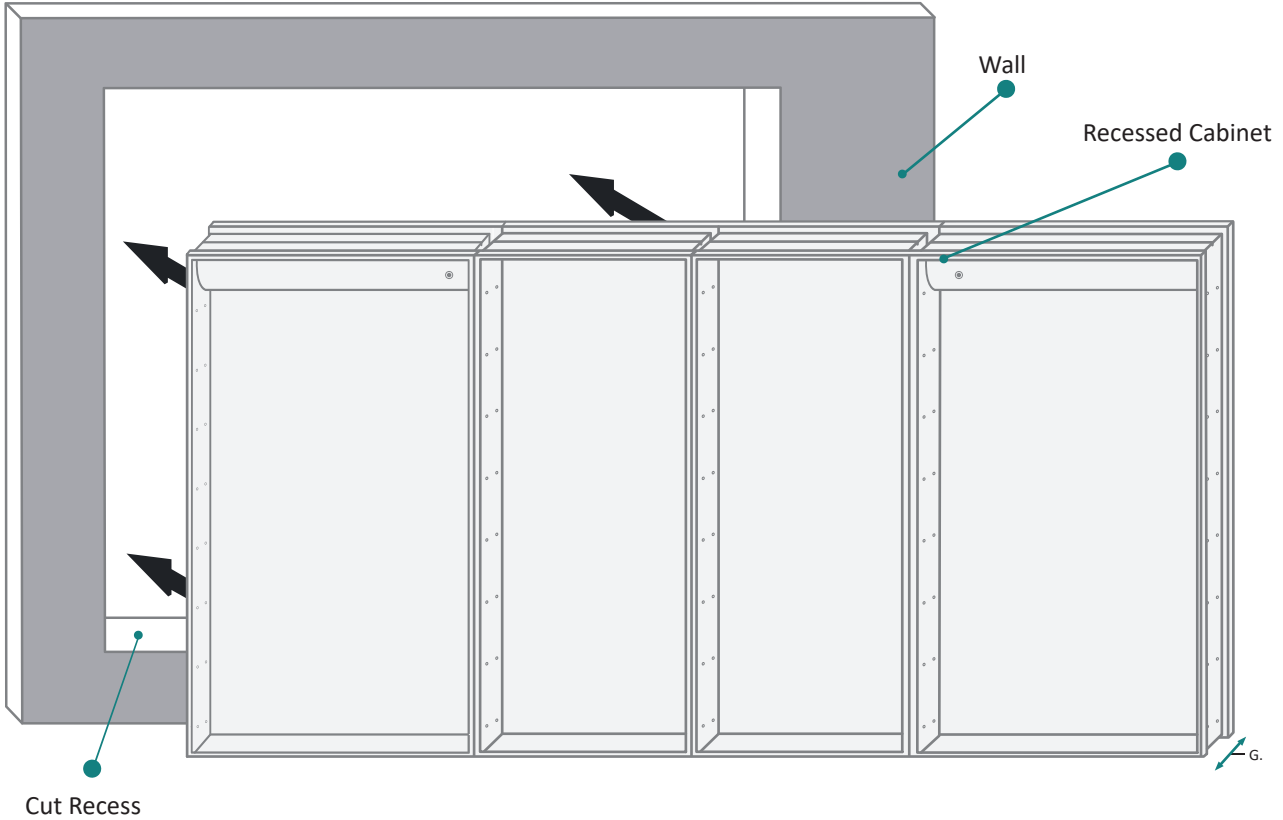

FRONT

BACK

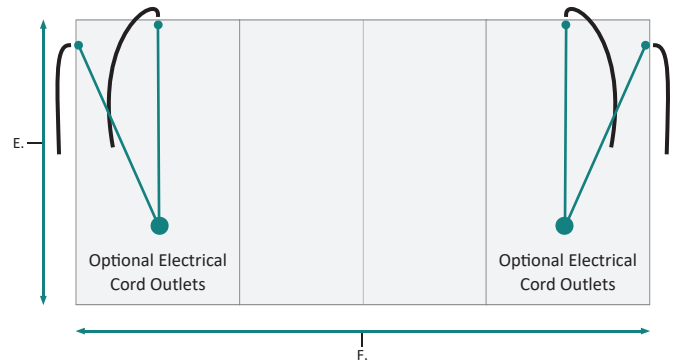
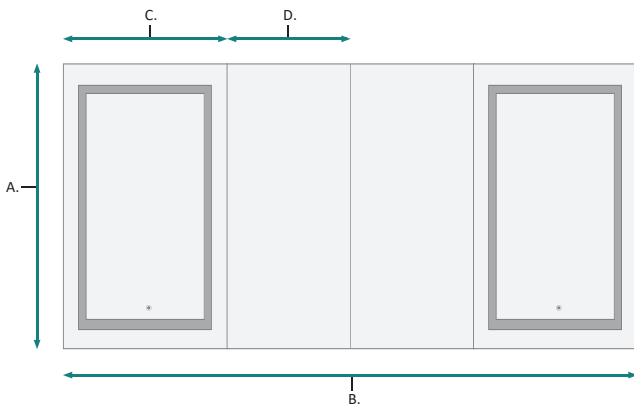

FRONT & BACKS

MODEL	A	B	C	D	E	F	G
SVANGE8442DLLRR	42	84	24	18	40-1/2	78	3-7/8

These measurements are for reference, for best results we suggest you measure actual product as small variations in size are possible

RECESS INSTALLATION OPTIONAL ELECTRICAL CORD LOCATIONS

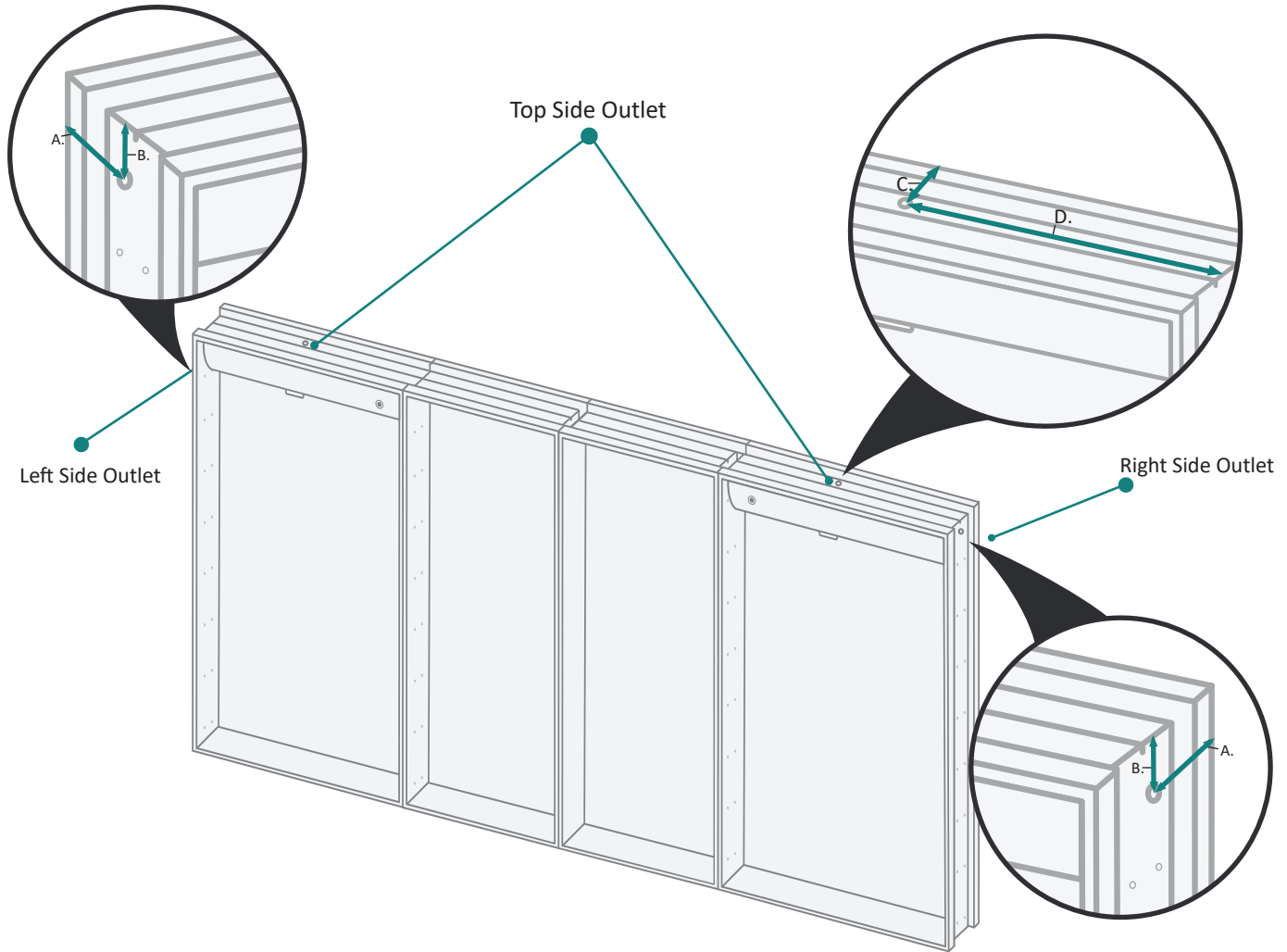

ELECTRICAL CORD LOCATIONS

MODEL	A	B	C	D
SVANGE8442DLLRR	1-1/2	1-1/8	1-3/8	11-1/4

These measurements are for reference, for best results we suggest you measure actual product as small variations in size are possible

SVANGE 8442DLLRR LED Medicine Cabinet - Specification Sheet

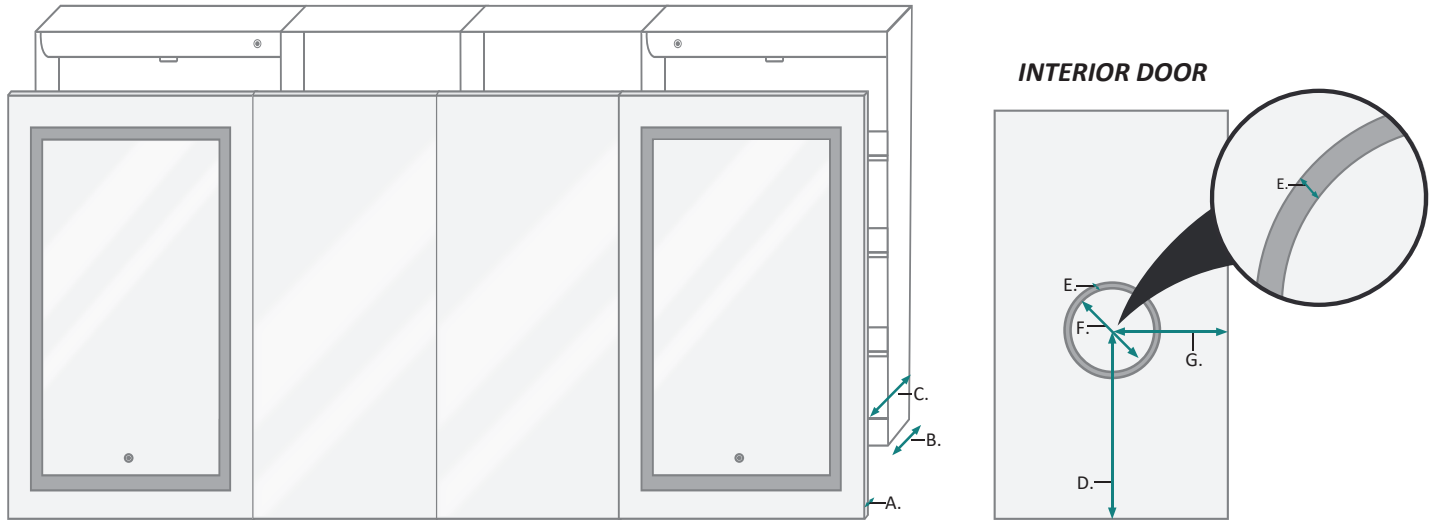

DOOR & CABINET

MODEL	A	B	C	D	E	F	G
SVANGE8442DLLRR	7/8	3-7/8	4-3/4	18	3/8	5-1/4	11-1/4

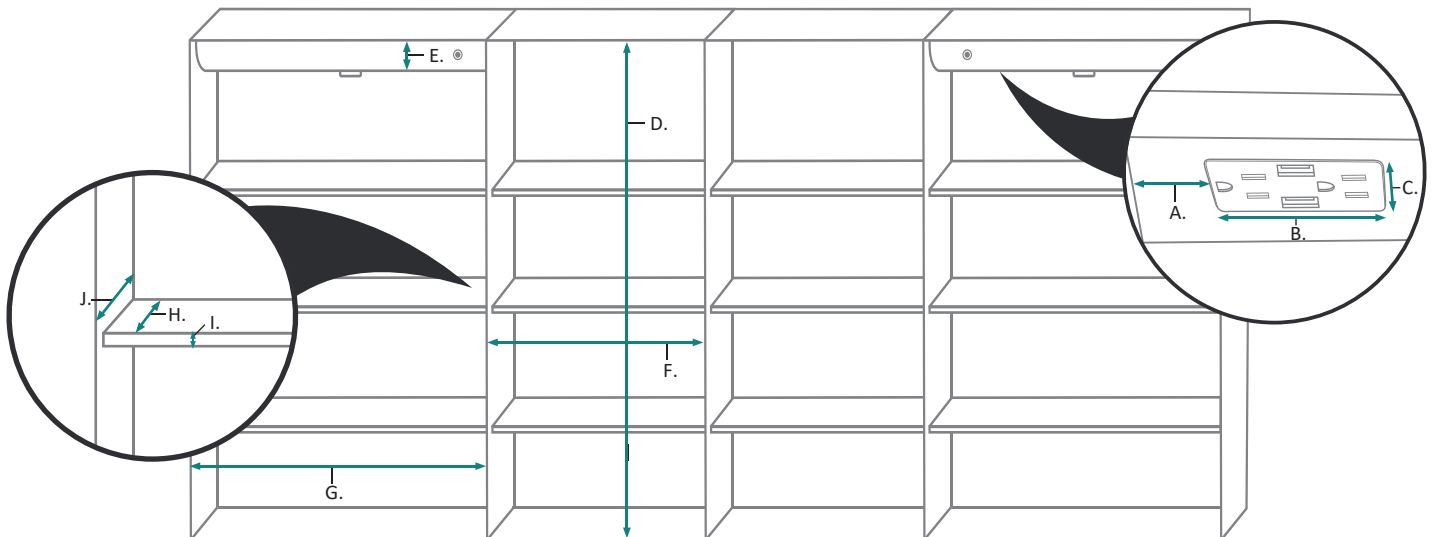

INTERIOR CABINET

MODEL	A	B	C	D	E	F	G	H	I	J
SVANGE8442DLLRR	3-3/4	5-5/8	1-1/4	40-1/2	2-1/4	16-1/2	22-1/2	2-3/8	3/8	3-5/8

These measurements are for reference, for best results we suggest you measure actual product as small variations in size are possible