



What You Need to Prepare Before Installing the Sauna

1. Choose the right Outdoor space and clear it out for the sauna.
2. When determining a location for your sauna, please keep in mind the following:
 - The main power cord on the sauna must be easily accessible.
 - When facing the sauna, the cord is located behind the back wall in the lower left hand side corner.
 - The location must be dry and leveled.
3. You will need a solid and leveled base. The sauna cannot sit straight on the ground.
4. Check the Electrical requirements for your specific unit and make sure you have it available. Please contact an electrician if you require assistance with this.
5. For a traditional heating system: Hardwire is recommended. Plug can be sent separately if preferred. For Infrared: it is a plug.
6. Prepare a Sealant to seal the sauna during the Installation of the sauna.
7. Tools: Phillips screwdriver, flat screwdriver, sealant gun. An Electric screwdriver will speed up the process.
8. Print or have your manual available during the installation.
9. Tech support for installation is available only at a pre-scheduled time. Submit a ticket online to schedule a time prior to **72 hours** of installation.
10. If you plan to have an electrician on site before the sauna arrives, schedule a phone call with our technician at least 72 hours in advance for a pre-installation process questions.



Electrical Components/Requirements

Please Read Carefully!

Infrared

Each sauna will require a dedicated circuit when plugged into an outlet according to the chart below. A “dedicated circuit” requires that no other appliance should share the outlet/circuit with the sauna. Failure to comply with this requirement may cause an electrical interruption and/or a diminished performance. To avoid any potential electrical hazards, it is recommended that only a qualified electrician installs your dedicated electrical wiring for a proper sauna functionality. Please make sure

that the sauna is properly grounded. Serious injury may result if the proper electrical requirements are not met.

WARNING! Keep the sauna away from any potential hazards, including any water source or liquids. Select a dry, suitable location for sauna installation. Do not expose the heater elements to any water source or liquids as it may cause electrical shock. Should you have any questions, please do not hesitate to contact the supplier.

Power Plugs

Please read the following directions carefully.

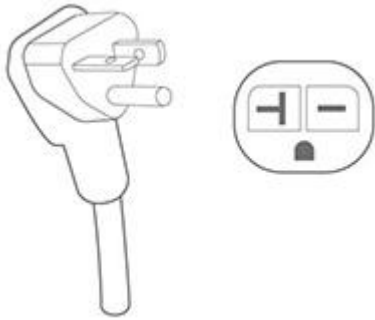

220V-above,

120V-below

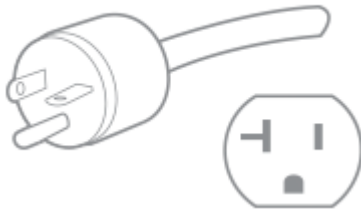

Power Usage/AMPS	
Wattage:	2650w
Voltage:	220/240 V
Voltage (Optional): 2350w, NEMA 5-20p	110/120 V
Near/Mid IR Wavelengths:	0 to 5
Far IR Wavelengths:	6 to 12
Amperage:	20 Amp minimum, 30 amp recommended*
Plug:	NEMA 6-20p

*Minimum 20 Amp is required for the dedicated circuit, if you run a new line we recommend for you to have 30 Amp available.



Choosing Sauna's Location

Your Enlighten outdoor sauna can stand outside without any cover or protection. The sauna requires a solid and level surface that will not flood. The saunas are very heavy so a solid foundation is highly recommended.

While Enlighten Outdoor saunas are specifically designed to be placed outdoors, choosing a location without excessive rain and wind is recommended.

Installation requirements for your sauna are as follows:

1. Your Enlighten sauna is a self-contained and freestanding unit. It should not be built into any structure without prior authorization.
2. Any modifications made to the sauna can waive the warranty, please get authorization before proceeding.
3. Please maintain a minimum of **4-inch clearance** on all sides of the unit to allow air to circulate while giving access for the power cord.



Sealant Application

VERY IMPORTANT: Please follow these steps during installation as they are very important to ensure the sauna is properly installed.

1. Prepare before the installation and use similar sealant to prevent any leaks from happening:



2. Apply sealant on the sides (as shown on the images) as well as on the bottom and top of walls.

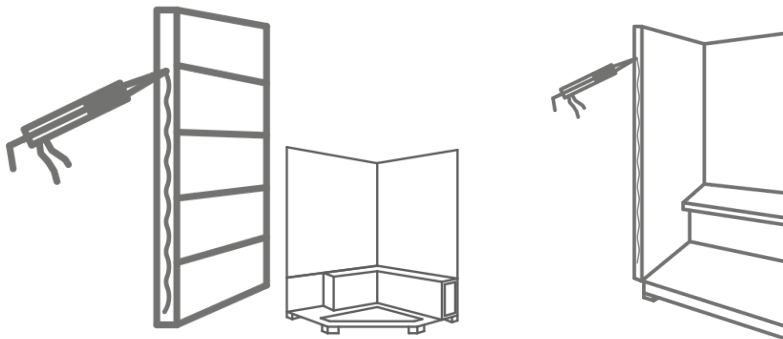

Cleaning and Maintenance

1. Before using your sauna for the first time, clean the inside of the sauna with a clean damp cloth.
2. Make sure to always keep the sauna dry and clean.

3. Use a clean damp towel. DO NOT use a towel that is too wet and can drip water inside the sauna and DO NOT use cleaning agents inside the sauna.
4. DO NOT leave towels, water glasses or bottles inside the sauna after use. Wipe the exterior surface of the sauna with a towel and clean the glass at least once a month.
5. Place a towel on the bench to absorb any perspiration. Wash these often to maintain a clean and pleasant environment inside your sauna.
6. Perspiration may darken the wood over time. This can be removed by a light sanding with fine grit sandpaper.

Wood Care

If the sauna exterior body has become scratched or scuffed, it could be concealed by using a small amount of furniture polish, oil or other furniture treatment. The interior blemishes, scratches, or scuffs can be either left alone, sanded or a combination of gluing plus sanding. Avoid any treatment containing benzene or a high concentration of alcohol.

Outdoor models' bodies need to be maintained on a regular basis (between 6 months to a year) by polishing or resealing the body as needed. If the varnish is cracked or worn off, sand the surface and re-varnish the affected area. Consult your local handyman or furniture repair professional for more details on how to maintain the wood in an outdoor environment. You can use any outdoor exterior clear wood sealer.



Sauna Installation Instructions

Please read the following directions carefully.

The sauna installation requires a minimum of 2 people, 5 person model sizes require at least 3 people to install. You should not try to install the sauna on your own as damage may easily occur. Please read the instructions thoroughly before and during assembly to ensure proper installation of the unit. If you encounter any problems or have questions during assembly, please feel free to call our Customer Support department.

Caution!

1. Install the sauna on a completely leveled surface.

2. Keep all liquids away from the Infrared heating panels.
3. Flammable objects and corrosive chemical substances should be kept far away from the sauna.

Your Infrared sauna will come packaged in five boxes if you choose a SLOPE roof (seven boxes for PEAK roof saunas). Please make sure that you open the boxes FACE-UP. Please be very careful when opening the boxes!

BOXES CONTAIN FRAGILE PARTS AND GLASS!

Please be careful when carrying and installing the glass pieces to avoid breakage.



Packaging

CONTENTS OF BOXES

1. Floor Panel.
2. Ceiling Panel
3. Accessories
4. Left Side Wall
5. Right Side Wall
6. Front Wall
7. Back Wall
8. Bench and Bench Support
9. Outdoor Roof (SLOPE OR PEAK)



Location of Sauna & Installation Order

When determining a location for your sauna, please keep in mind the following:

1. The main power cord on the sauna must be easily accessible.
2. The location must be dry and level.
3. Panels should be installed in the following order:

1) Floor	4) Right Side Wall	7) Front Wall
2) Back Wall	5) Under Bench Support	8) Ceiling
3) Left Side Wall	6) Bench	9) Outdoor Roof

Connecting the Panels:

Each sauna offers two types of panel-locking systems to connect the different sides of the sauna. Please use the instructions below as a reference guide on how to connect the sauna panels.

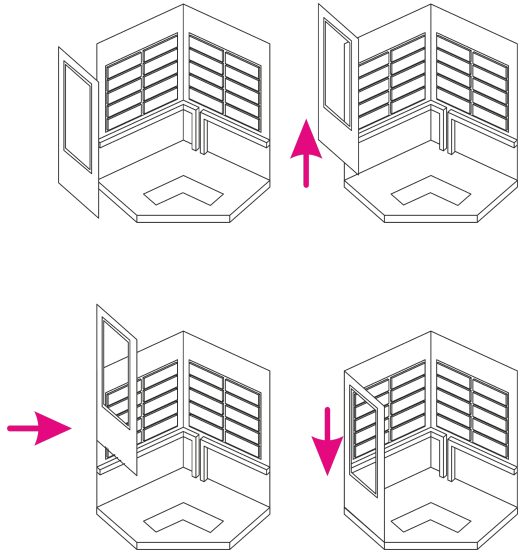

Figure G-1: Connect panels, inner lock system

1. Lift the panel with the male locks a few inches.
2. Push it against the opposite panel; make sure to apply pressure around the top and bottom corners.
3. Slide the panel down to lock it in place. Make sure all the locks are connected (top and bottom).
4. Inspect the panels and make sure they are leveled (the panel's top is flat and matching).

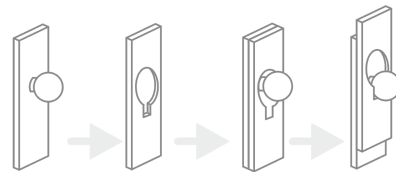

Figure G-2: Inner-Locking System

Latch System:

The Latch Locking System is two brackets that lock together bypassing the main loop over the opposite side and locking latch (Figure G-3).

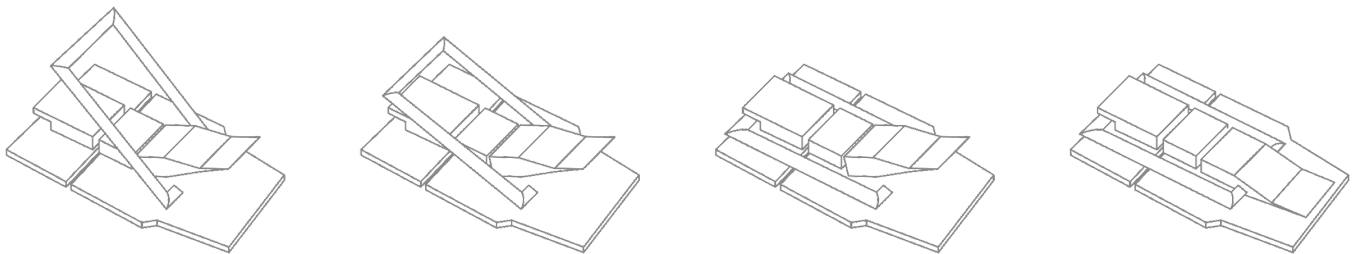

Figure G-3: Latch Locking System

Where to Start:

Lay the boxes flat on the ground and open them carefully. The accessories, user manual, and smaller parts are located in the box that includes the top and bottom panels (Figure G-4).

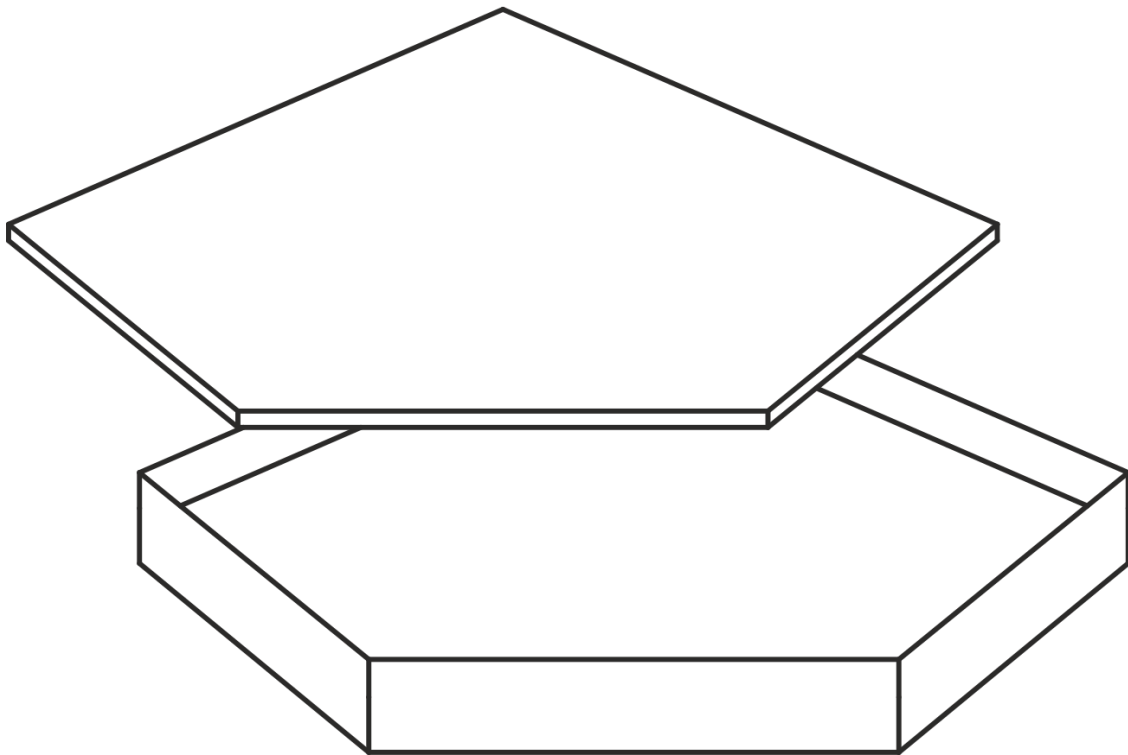

Figure G-4: Open the Box to uncover accessories

CORNER MODELS – INSTALLATION INSTRUCTIONS:

FRONT PANEL Placement:

Place the floor panel flat on the desired location. Make sure to leave a space around the sidewalls for one person to stand and install the side panels (Figure B-1). You can slide the sauna once it's complete next to a wall.

Tips:

- The triangle corner will point to the back of the sauna and the heater (on some models) point to the front of the sauna.

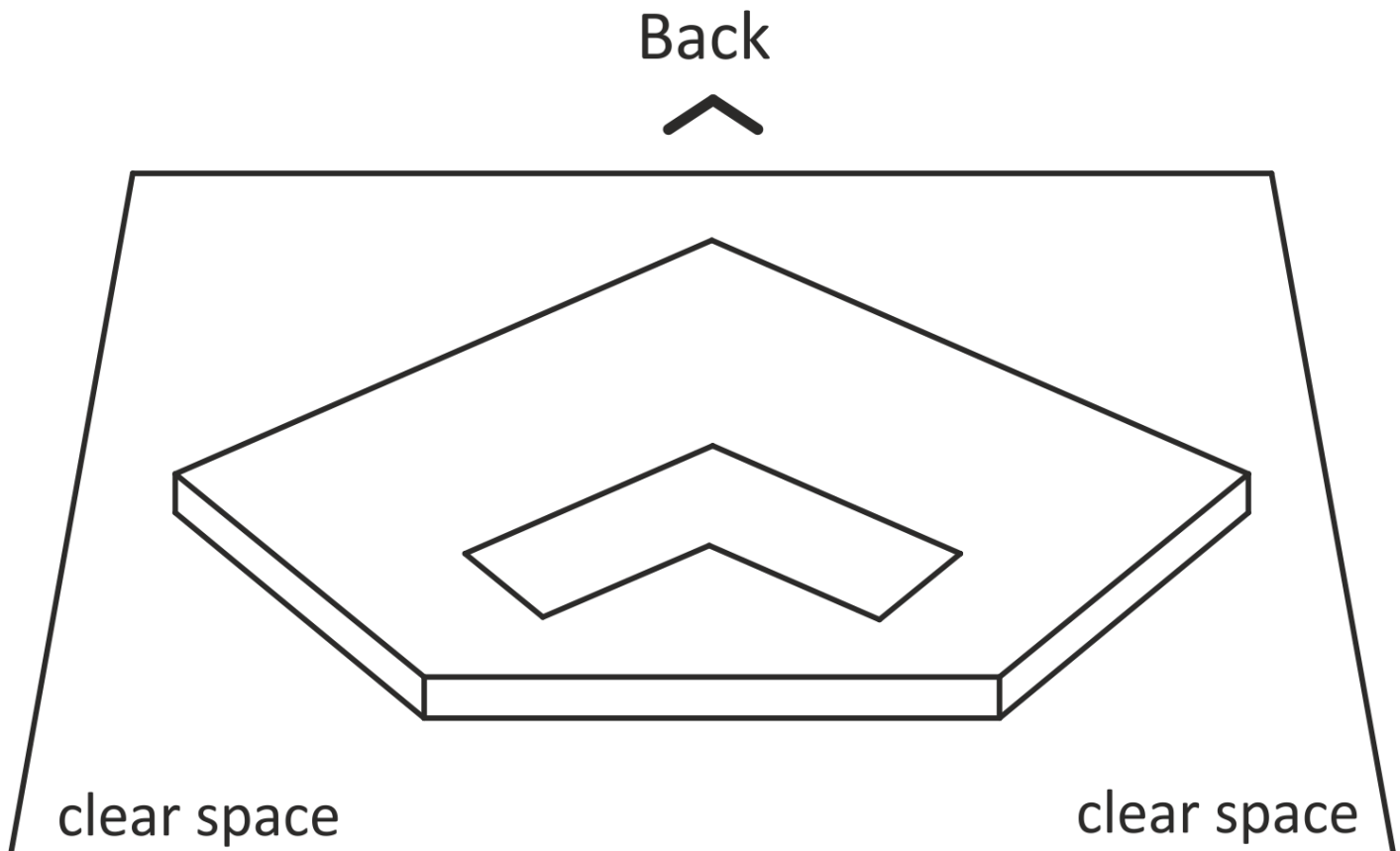

Figure B-1: Floor Panel

FIRST BACK PANEL Placement:

Place the first back panel on the floor panel as an image on page 15 (Figure B-2). At this point, someone should hold the back panel until the next connection is made.

Tips:

- The first panel will have female locks on both sides.

SECOND BACK PANEL Placement:

Connect the second back panel to the first panel as the image on page 15 (Figure B-3). Refer to “Connecting the Panels” section (page 4) on how to lock the panels together.

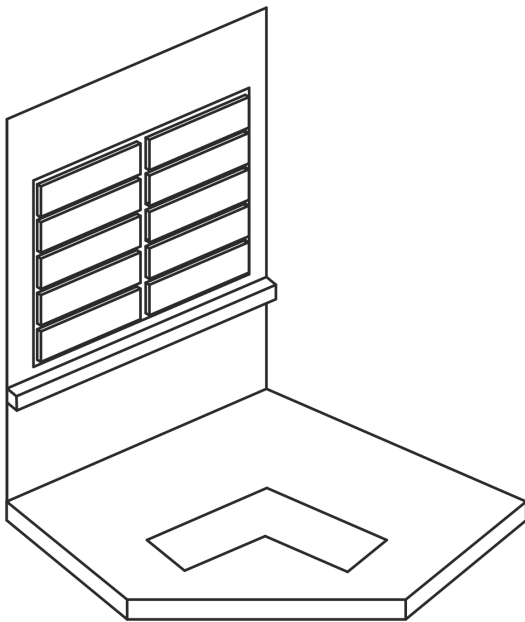

Figure B-2: First Back Panel

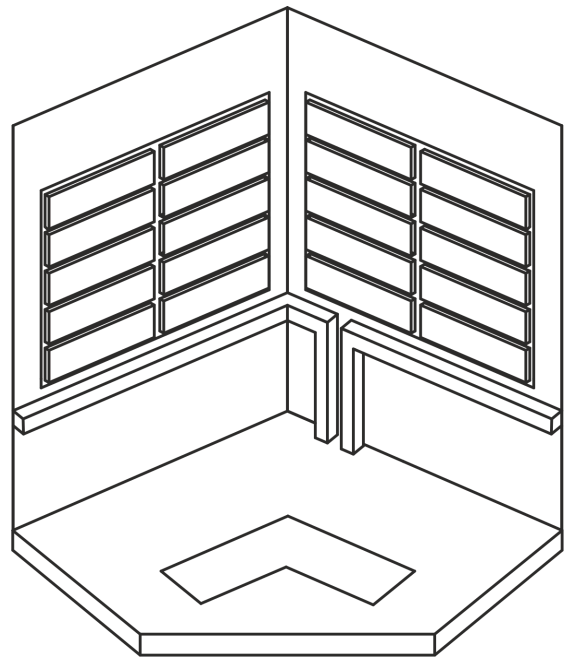

Figure B-3: Second Back Panel

FRONT SIDES Placement:

Install the two front side panels (Figure B-4).

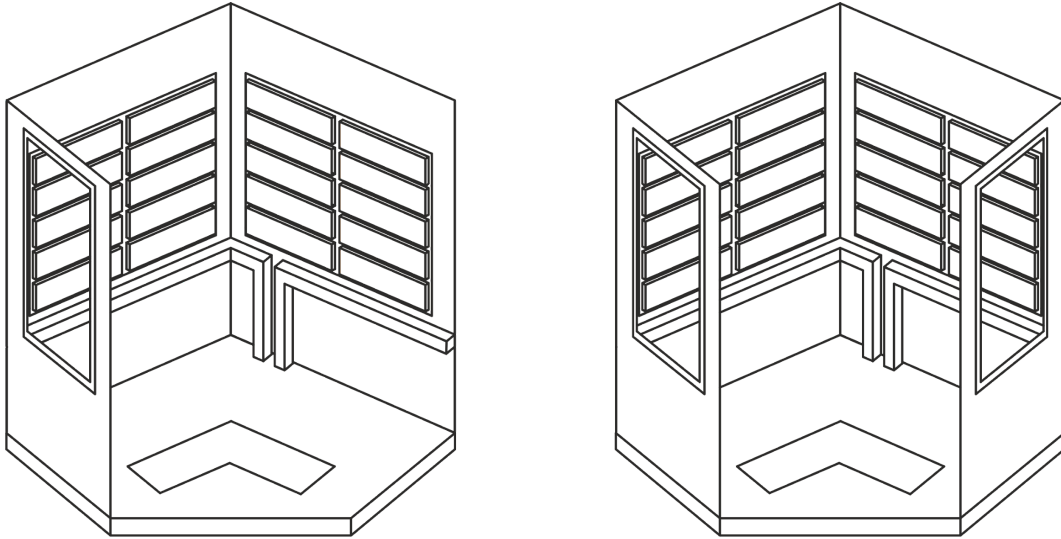
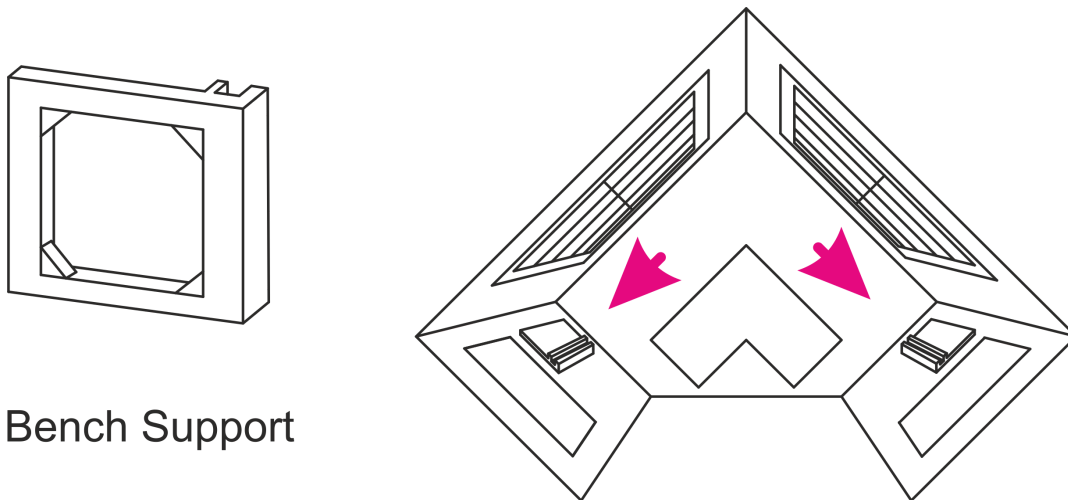

Figure B-4: Installing the front panels

ASSEMBLY OF BENCHES:

Some saunas will include square bench support. Place it in front of the windows (Figure B-5, Page 16).



Bench Support

Figure B-5: Bench Support

Place the bench stand panels by lining up its side with the vertical guides on the back panels. Connect the heaters' plugs under the bench and slide the bench panel over the horizontal guide on the back panels. Make sure the smooth and finished side is facing up and forward (Figure B-6).

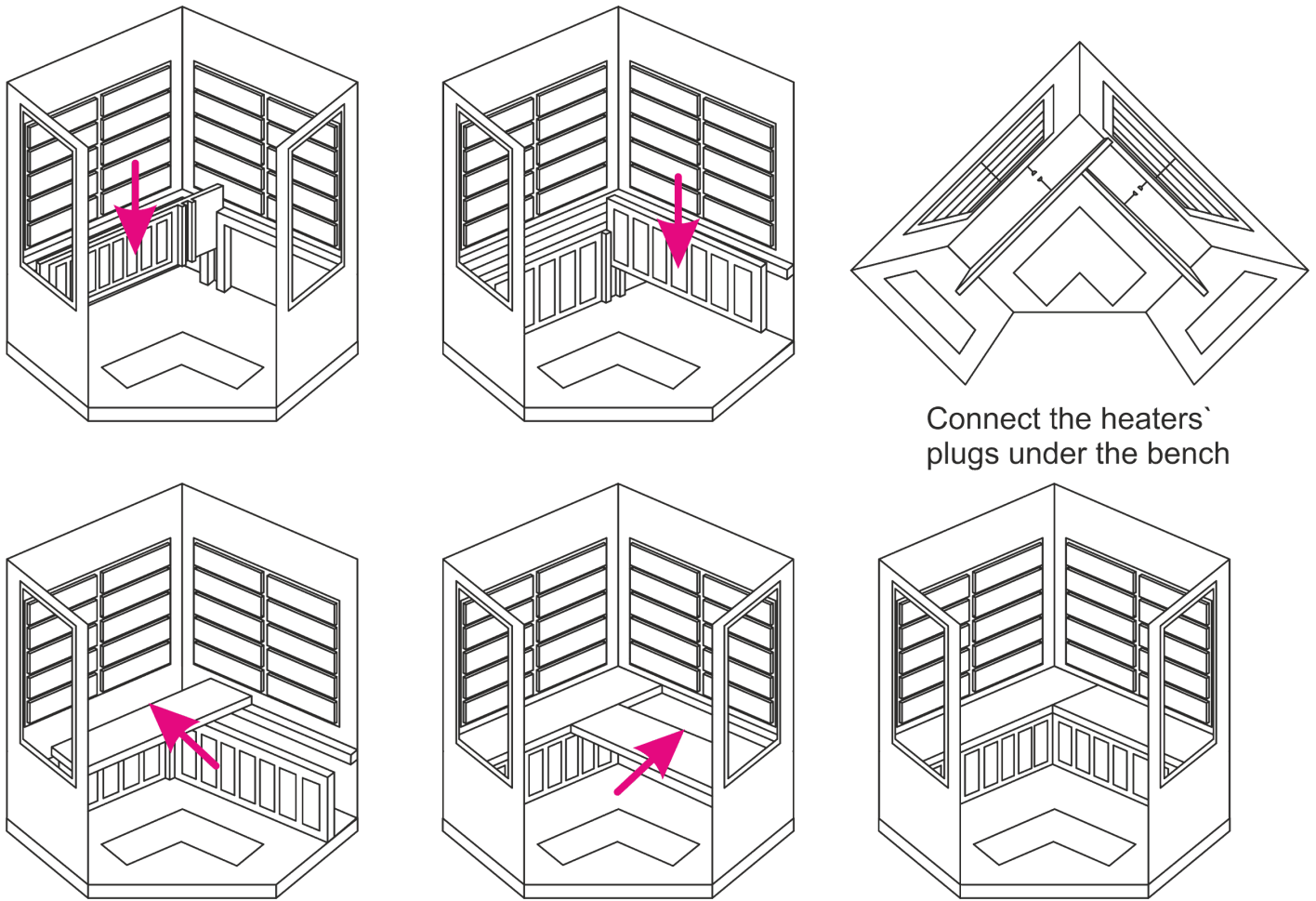

Figure B-6: Bench Installation

DOOR PANEL Placement:

Note: Install the door handle first.

Connect the door panel to the front side panels. For the inner-lock system, make sure to match the edges of the front panels to the corners of the door panel (Figure B-7 below).

Tips:

- The front panel is heavy because of the glass door. At least two people are needed to lift it.
- For the inner lock system, a person should stand inside the sauna to align the corners and edges of the panels.
- For the inner locking system, make sure to put pressure on the top and bottom corners of each side to ensure the locks are connecting.

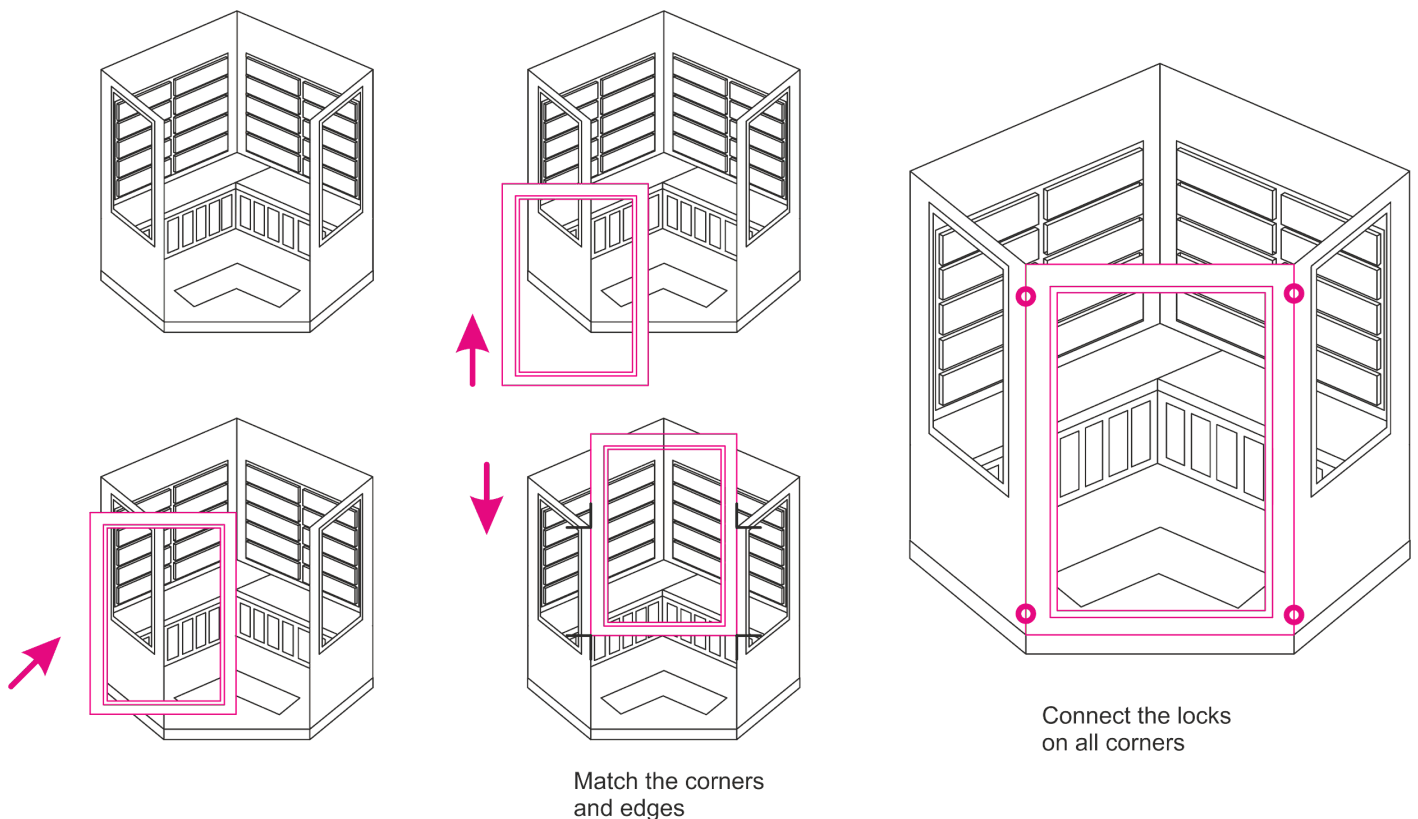

Figure B-7: Front Panel

TOP PANEL Placement:

Step 1. Raise the top panel over the sauna body. Insert the wires for the control panel, temperature sensors, and heaters through the openings in the ceiling.

Step 2. Connect the control panel wire (white ribbon) and the heat sensor (2-pin wire) on top of the sauna.

Step 3. Connect the heaters' plugs into the control box. Even though the heaters' plugs might be labeled, they can connect into any sockets on the control box (Figure B-8).

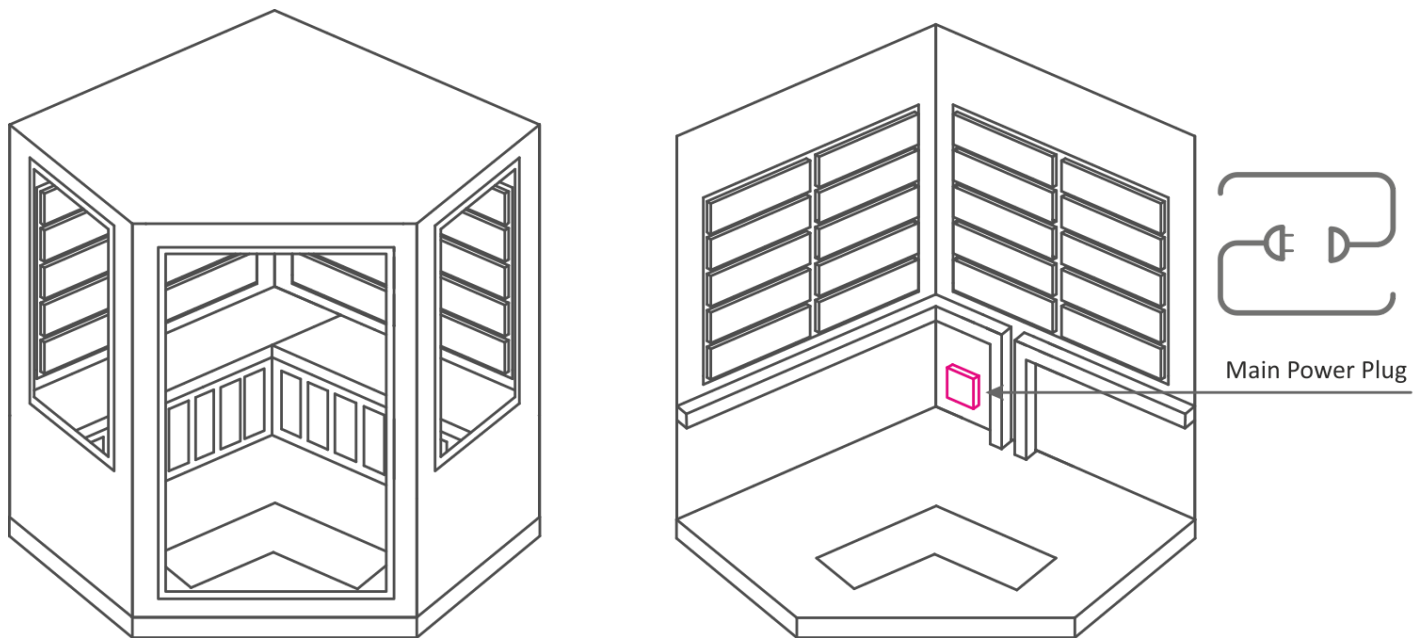

Figure B-8: Top Panels and Connections

NOTE: Accessories installation instructions continue below the outdoor models.

If you bought an Indoor Version, the Top Panel is your Indoor Roof. Skip OUTDOOR ROOF ASSEMBLY INSTRUCTIONS.

If you bought an Outdoor Version, please proceed with the OUTDOOR ROOF ASSEMBLY INSTRUCTIONS.

OUTDOOR SAUNAS ASSEMBLY INSTRUCTIONS:

Installation steps start at the section [“Assembly Instructions – General Guide”](#). Then continue after placing the top panel.

Main Support

Place the roof bottom section on top of the sauna and screw the center support beam (Figure D-1). The illustration below will not include the sauna’s body, but the roof should be installed on top of the sauna.

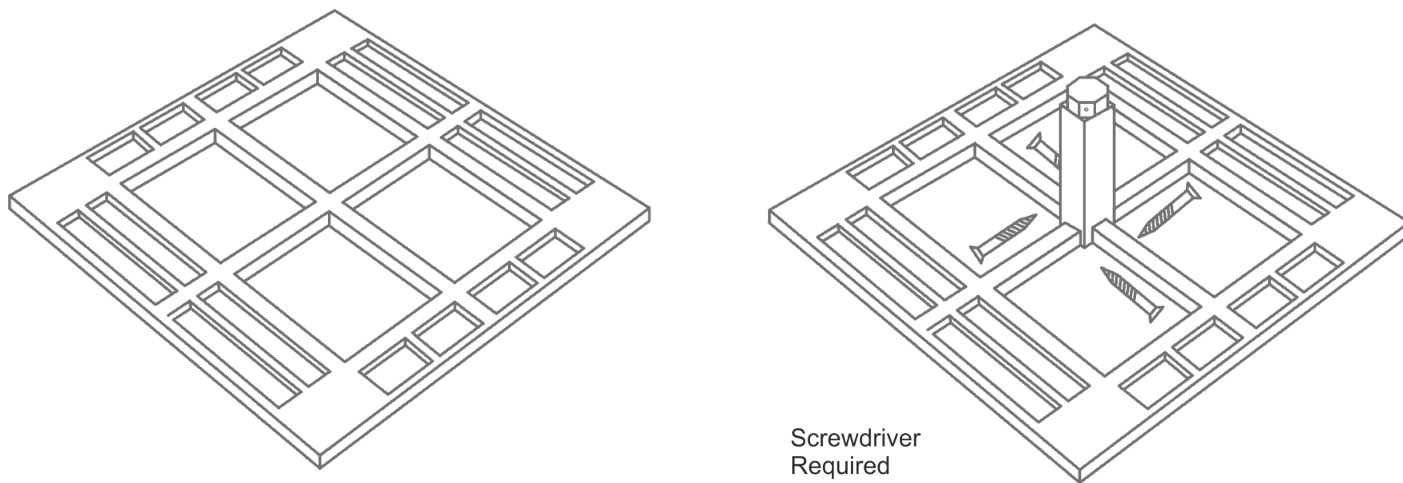

Figure D-1: Roof bottom section and center support beam

Roofing Shingles Support

Install the roofing shingles support beams around the top. Each beam is labeled alphabetically to a matching corner or side (Figure D-2, Page 25). For example, the beam marked with “A” should be screwed into the “A” corner. Repeat for all the corners and sides (based on the model, you might have eight or six supporting beams).

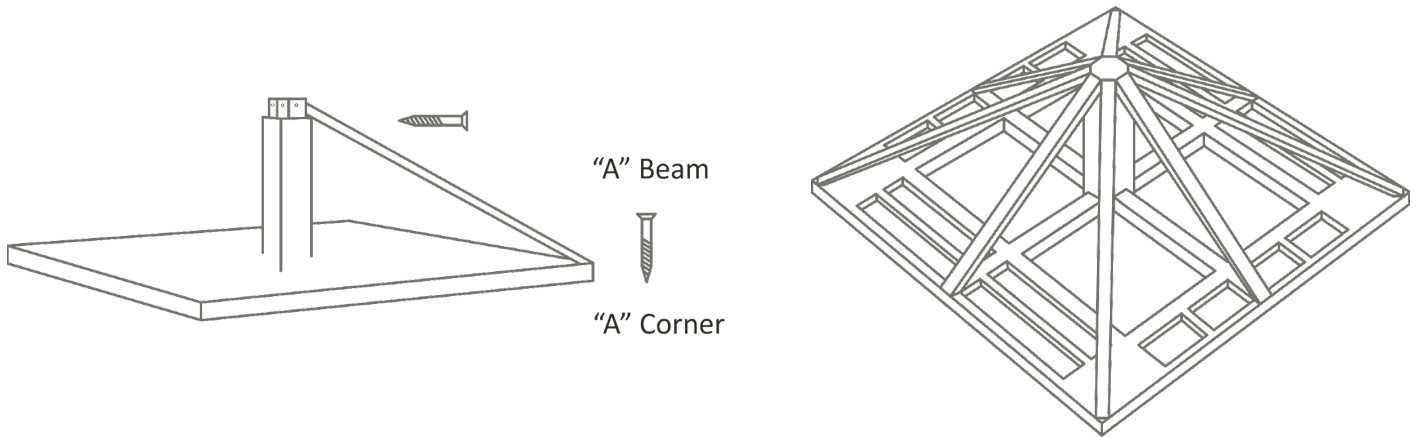

Figure D-2: Shingles Support Beams

Screw the triangular roofing shingles on the supporting beams (Figure D-3). Repeat for all sides.

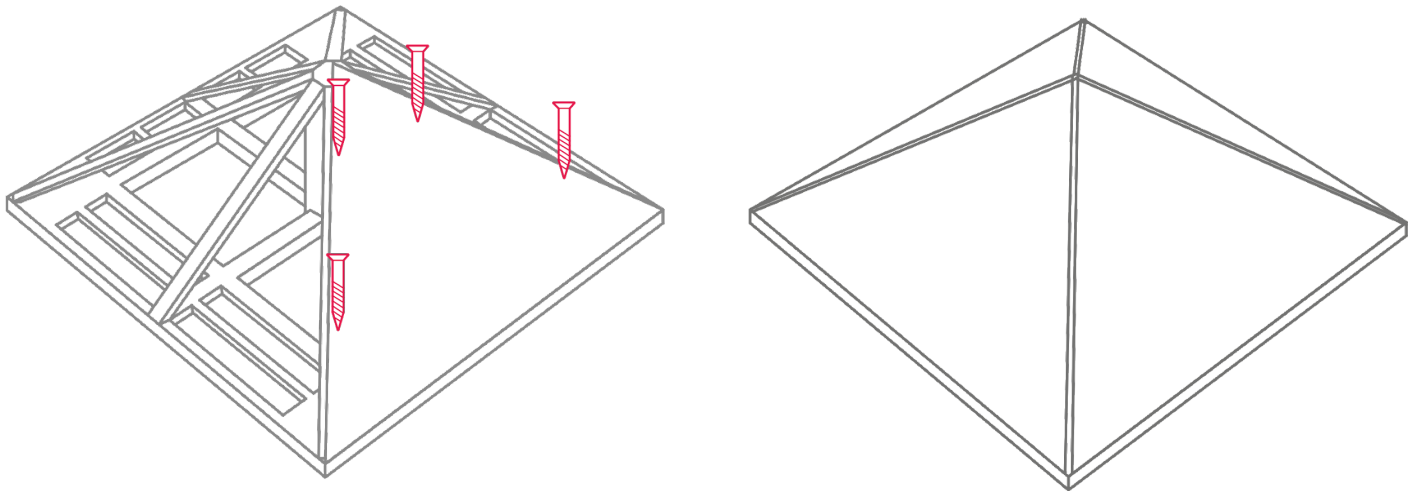

Figure D-3: Roofing Shingles

Roof Sealing

Screw the corner roof shingles around all corners. Each corner will have two shingles curved upward to easily identify the position of the screws (Figure D-4).

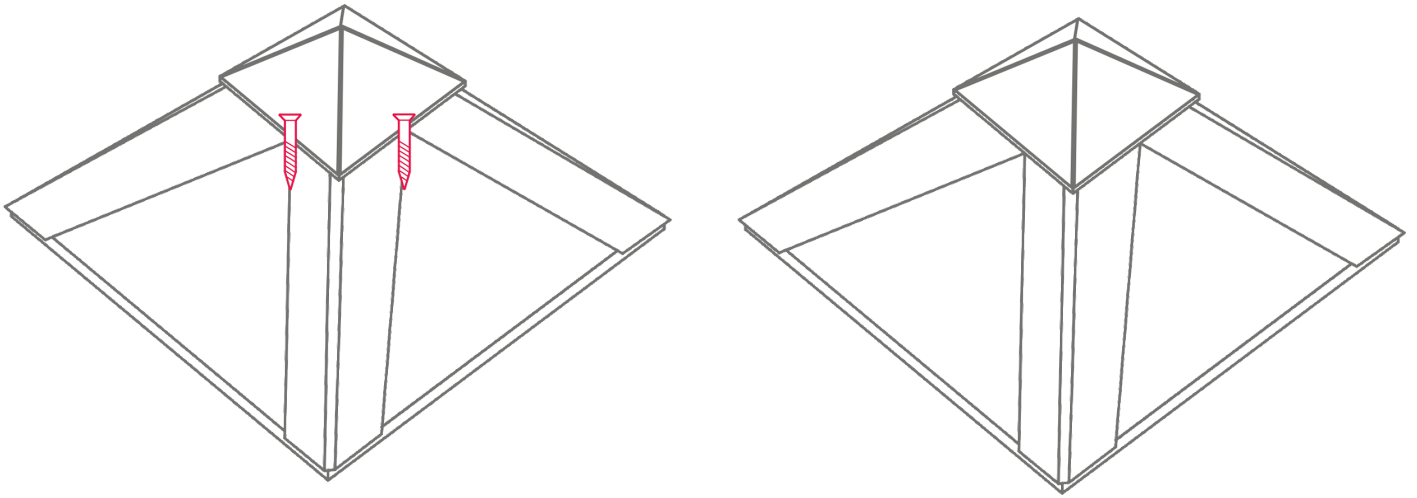

Figure D-4: Corner Roof Shingles

After screwing in the corners, flatten the curved shingles and place the pyramid roof shingles on top (Figure D-5).

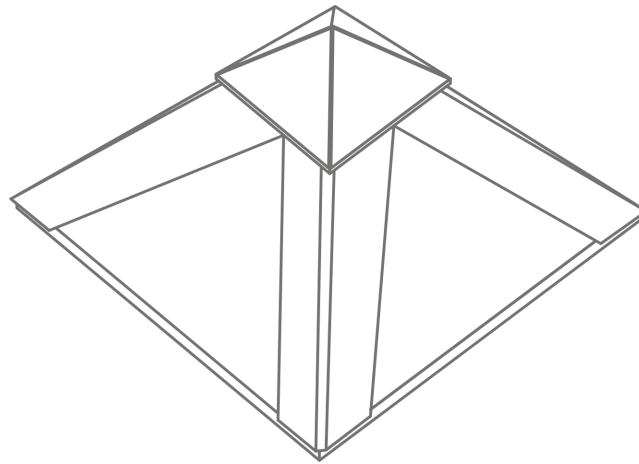

Figure D-5: Pyramid Roof Shingles



Full Spectrum Heater Installation for Diamond Models

Step 1.

Locate the wooden bracket and full spectrum heater.

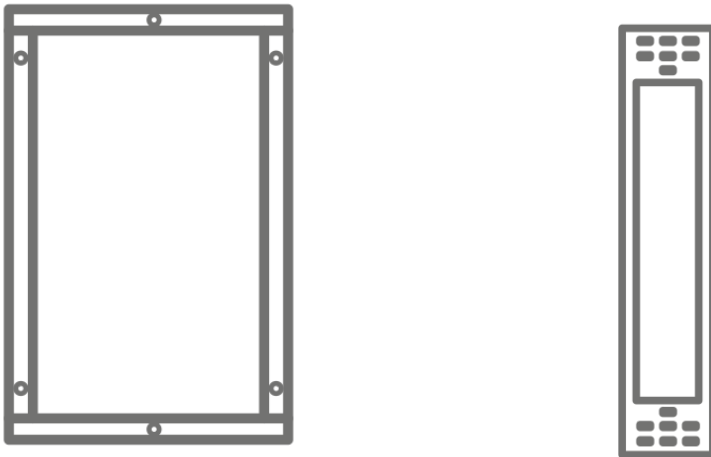

Step 2.

Align the holes from the wooden bracket to the holes on the back of the full spectrum heater.

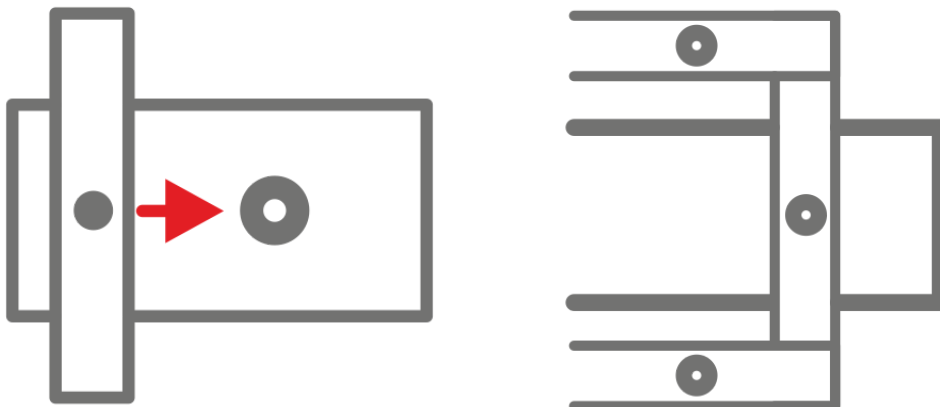

Step 3.

Screw on the bolt.

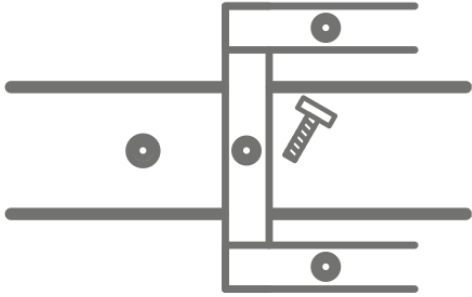

Step 4.

Place 2 full spectrum heaters on the front wall besides the door.

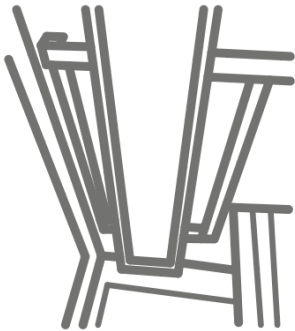

ACCESSORIES

Oxygen Ionizer (Recommended)

Locate the ionizer plug which is extended out of the sauna ceiling (1-pin plug). Connect the oxygen ionizer and screw it into the back panel.

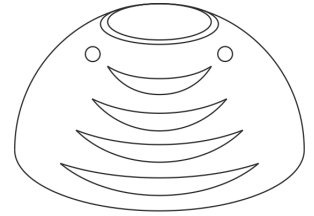

Cup Holder (Optional)

The cup holder is a small wooden table that can be screwed in one of the front corners (either right or left, based on the user preferences). Make sure not to install the cup holders on or in front of the heaters. Some models with a glass front or corner saunas will not include the cup holder.

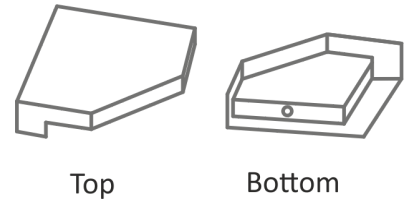

Magazine Holder (Optional)

The magazine holder can be installed either on the front wall (in front of the window) or in the sidewall (next to the legs) (the placement of the magazine holder is optional based on the user preferences). Do NOT install the magazine holder in front of the heaters. The magazine holder size might vary based on the model.



Towel Rack (Optional)

For models with full glass doors, the towel rack can be installed either on the front wall or on the sidewall (the placement of the towel rack is optional based on the user preferences). Do NOT install the towel rack in front of the heaters.

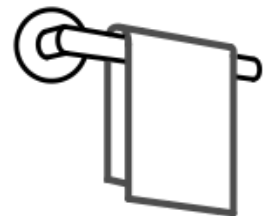

For models with glass and wooden frame doors or wooden doors, install the towel rack in the middle of the door frame and use it as a door handle.

AM/FM RADIO/MP3 player, BLUETOOTH should all be pre-installed on the key pad.



Color Therapy Lights (Recommended)

Some models will include color therapy lights (or chromo lights aka chromotherapy). Color therapy lights function as light therapy for physical and mental health. Scientists have determined that each color emits a frequency.

Our body consists of Seven Layers of the Auric Field and the Seven Chakras (energy centers of the body). Each layer looks different and each has its own particular function. Each layer of our Aura is associated with a chakra (1st layer with 1st chakra, and so on). See a chart below:

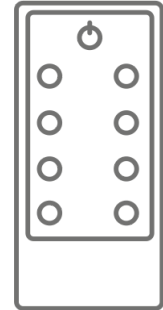

Chakra – Root Chakra (RED)

Location: The end of the spine, between the anus and the sexual organs

Function/Qualities: Security/Safety, Stability

Function when disturbed/unhealthy: Fear, insecurity. Life feels like a burden. Feeling of not belonging.

Physical Health: Weak constitution, elimination problems. Reduced physical and mental resistance.

2nd Chakra – Sacral Chakra (ORANGE)

Location: The Sexual Organs

Function: patience, Healthy/Positive Emotions towards Sexuality, Creativity, Responsible Relations

Function when disturbed/unhealthy: Rigid emotions, frigidity, guilt, no boundaries.

Physical Health: Problems with reproductive organs, kidneys.

3rd Chakra – Navel (YELLOW)

Location: Navel Point – Solar Plexus

Function/Qualities: Center of personal power and commitment;

Self-esteem, dignity, identity, judgment.

Place of inner balance and inspiration. Function when disturbed/unhealthy: Anger, greed, shame, despair;

No strength or spontaneity. Conforming in order to be recognized;

Suppressing one's own wishes/emotions to please others.

Physical Health: Problems with digestion, the liver, gallbladder, the pancreas.

4th Chakra – Heart Chakra (GREEN)

Location: The middle of the chest on the breast bone.

Function/Qualities: Compassion, kindness, forgiveness, service, love

Function when disturbed/unhealthy: Grief, Attachment, Easily Hurt. Emotional dependence on others. Heartlessness.

Physical Health: Heart problems, lung problems, blood pressure problems.

5th Chakra – Throat Chakra (LIGHT BLUE)

Location: The throat

Function/Qualities: Language; Ability to communicate effectively; Authenticity; Inspiring, teaching.

Function when disturbed/unhealthy: Lethargy, weakness in expressive abilities; Shyness, voice problems, insecurity, fear of others' judgments/opinions.

Physical Health: Throat, neck, thyroid problems.

6th Chakra – Third Eye (INDIGO BLUE)

Location: Between the eyebrows.

Function/Qualities: High Intuition; Clairvoyance; Visualizing; Fantasizing; Concentration and determination; Self-Initiation; Power of projection; Understanding your purpose.

Function when disturbed/unhealthy: Confusion, Depression. Rejection of spirituality; Over-intellectualizing.

Physical Health: Depression, Panic, Mental Disorders.

7th Chakra – Crown Chakra (VIOLET)

Location: Crown of the head.

Function/Qualities: Spiritual Connection; Connection to the Higher Self; Unity; Enlightenment; Universal Awareness

Function when disturbed/unhealthy: Grief; Feeling of being separated from existence/abundance. Fear of death. Mental Health: Complete separation and dis-illusion from oneself; grief, sadness, false/limiting beliefs.

8th Chakra – Aura (WHITE)

Location: The electromagnetic field (contains all colors above)

Function/Qualities: Aura combines all the effects of the chakras and offers their projection. Aura projects and protects.

Function when disturbed/unhealthy: Shy, withdrawn, vulnerable.

Physical/Mental Health: Overall weakness in mind and body.

Operating Instructions:

The color lights are operated by remote control only. Press any color on the remote control to turn the lights on and select a color. You may then press the "Cycle" button (lower right button) to cycle through the colors randomly. Press the "Power" button to turn the lights off.