

series
Ornellaia



CR

CHROME

PW

BRUSHED
NICKEL



Certified by
EPA

87..211

Single handle lavatory faucet.
 7 3/8" overall height.
 6" 3/16" spout reach.
 2 3/4" maximum deck thickness.
 Deck plate & pop-up drain included.

Flow Rate: 1.2 GPM @ 60 PSI

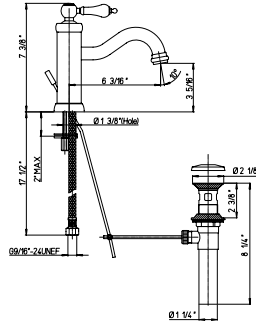

\$330,00	\$385,00	NA
----------	----------	----



87..211LL

Single handle lavatory faucet.
 13 11/16" overall height.
 6 1/4" spout reach.
 2 3/4" maximum deck thickness.
 Push drain included.

Flow Rate: 1.2 GPM @ 60 PSI

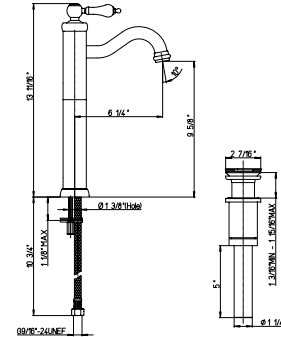

\$396,00	\$467,50	NA
----------	----------	----



87..214

Widespread lavatory faucet.
 8" centers.
 7 1/8" overall height.
 6 5/8" spout reach. Spout rotates.
 2 3/4" maximum deck thickness.
 Pop-up drain included.

Flow Rate: 1.2 GPM @ 60 PSI

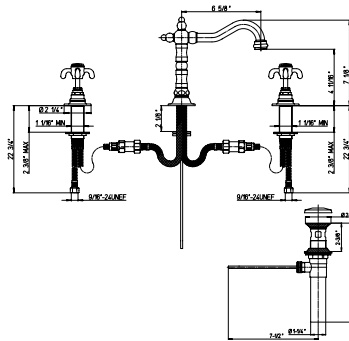

\$407,00	\$533,50	NA
----------	----------	----

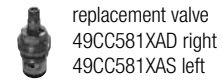

87..214W

Widespread lavatory faucet.
 8" centers.
 7" overall height.
 5 3/8" spout reach. Spout rotates.
 2 3/4" maximum deck thickness.
 Pop-up drain included.

Flow Rate: 1.2 GPM @ 60 PSI

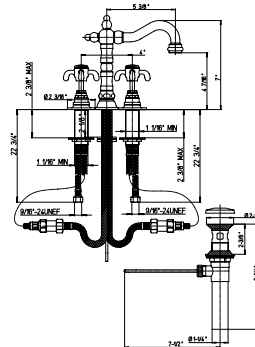

\$396,00	\$522,50	NA
----------	----------	----

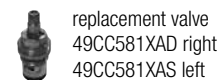

87..207

Wall mount lavatory faucet.
 8" centers.
 6 7/8" spout reach.

Flow Rate: 1.2 GPM @ 60 PSI

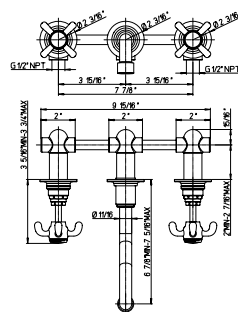

\$407,00	\$539,00	NA
----------	----------	----





87..102

\$660,00 \$797,50 NA

Roman tub.
7 15/16" spout height.
8 5/8" spout reach.
2 3/4" maximum deck thickness.

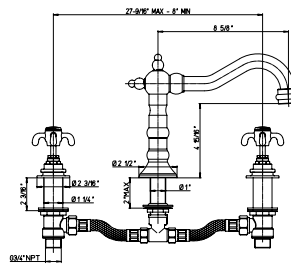
Flow Rate: 9.6 GPM @ 60 PSI



 replacement valve
53CC5813/4D right
53CC5813/4S left

87..109

\$880,00 \$1.017,50 NA

Roman tub with diverter
and hand held shower.
7 15/16" spout height.
8 5/8" spout reach.
2 3/4" maximum deck thickness.

Flow Rate: 9.6 GPM @ 60 PSI

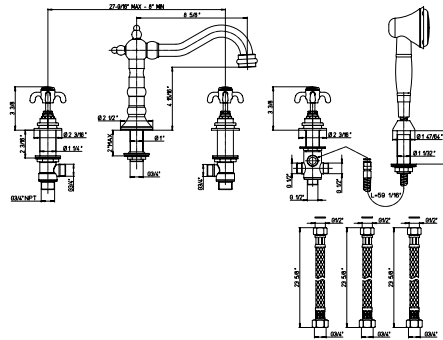

 replacement valve
53CC5813/4D right
53CC5813/4S left

87..136

\$1.265,00 \$1.430,00 NA

Floor mounted tub filler.
Single Hole Free-Standing
Tub Filler with Hand held shower.

Flow Rate: 7.0 GPM @ 60 PSI
Flow Rate and spray: 1.8 GPM
@ 80 PSI

NEEDS ROUGH VALVE 136

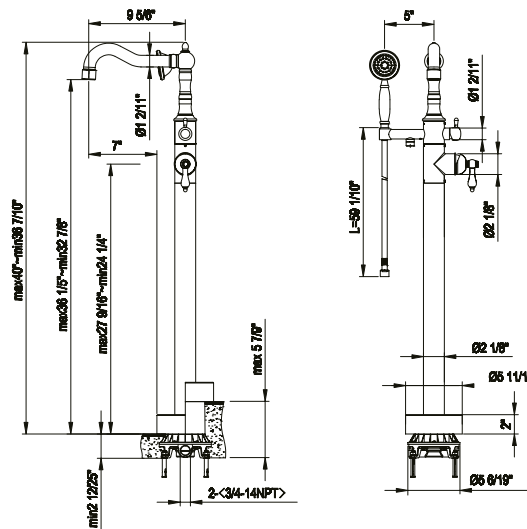

 replacement valve
diverter cartridge
53CC956G25

 volume control
53CC956G11

VALVE 136

\$00.00

 Rough-in Valve
 3/4" inch inlet connections

Flows 9.0 GPM @ 60 PSI

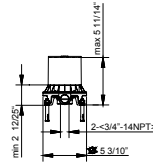
VALVE 690

\$190.00

 Thermostatic Valve
 with 3/4" volume control
 1/2" inch inlet connections

Flows 7.1 GPM @ 60 PSI

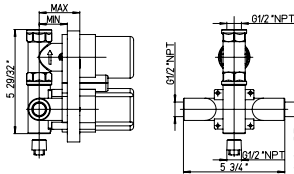
VALVE 691

\$200.00

 Thermostatic Valve
 2 ways diverter cartridge
 1/2" inch inlet connections

Flows 5.5 GPM @ 60 PSI

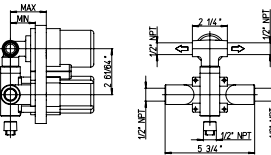
VALVE 400

\$82.50

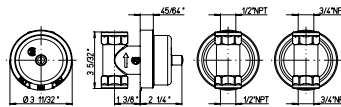
 1/2" Volume Control
 3/4" inch inlet connections
 Flows 12.5 GPM @ 60 PSI

VALVE 402

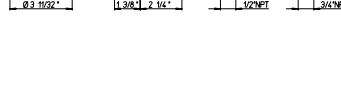
\$137.50

 3/4" Volume Control
 3/4" inch inlet connections
 Flows 15.0 GPM @ 60 PSI

VALVE 425

\$137.50

 3 ways Diverter Rough-in Valve
 1/2" inch inlet connections

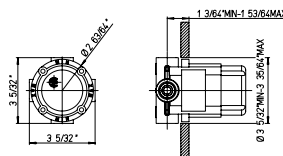
Flows 9.7 GPM @ 60 PSI



KIT 2

- Thermostatic tub & shower KIT including:
- 8" Brass Round rain shower head - Anti Limestone
 - 12" Brass Round wall mounted arm & flange
 - Trim 691 with thermostatic valve & 2 way diverter volume control
 - Rough in valve 691
 - 8" Brass tub spout
 - 1/2" inlet connections

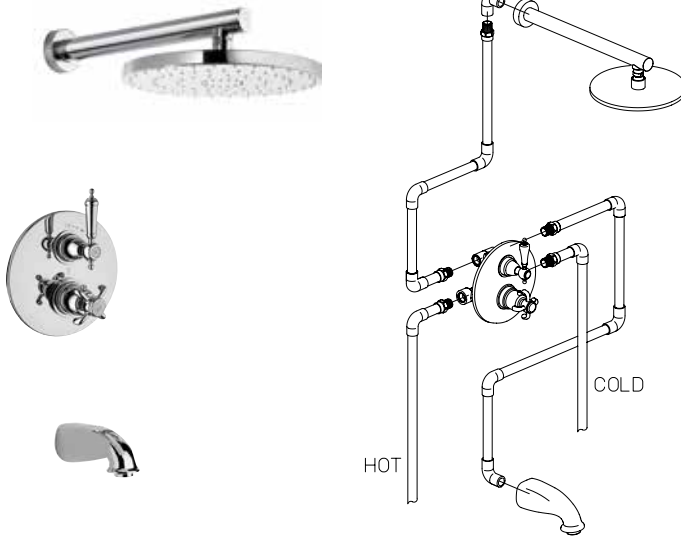

\$770,00	\$979,00	NA
----------	----------	----

KIT 4

- Thermostatic shower KIT including:
- 8" Brass round rain shower head - Anti Limestone
 - 12" Brass round wall mounted arm & flange
 - Trim 690 with thermostatic valve & 3/4" ceramic disc volume control
 - Rough in valve 690
 - 1/2" inlet connections

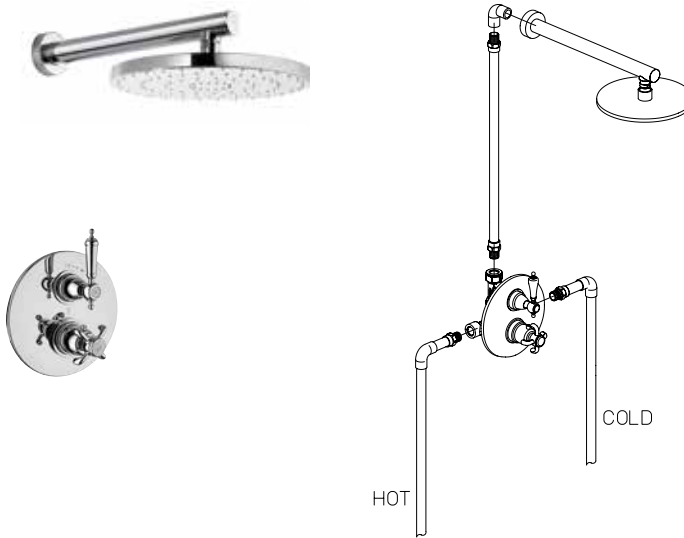

\$612,00	\$786,00	NA
----------	----------	----

KIT 6

- Thermostatic hand shower KIT including:
- 8" Brass round rain shower head - Anti Limestone
 - 12" Brass round wall mounted arm & flange
 - Trim 691 with thermostatic valve & 2 way diverter volume control
 - Rough in valve 691
 - Round wall mounted brass handshower set including 1-jet round handshower, wall mounted bracket & supply elbow + flange, 78" flexible hose
 - 1/2" inlet connections

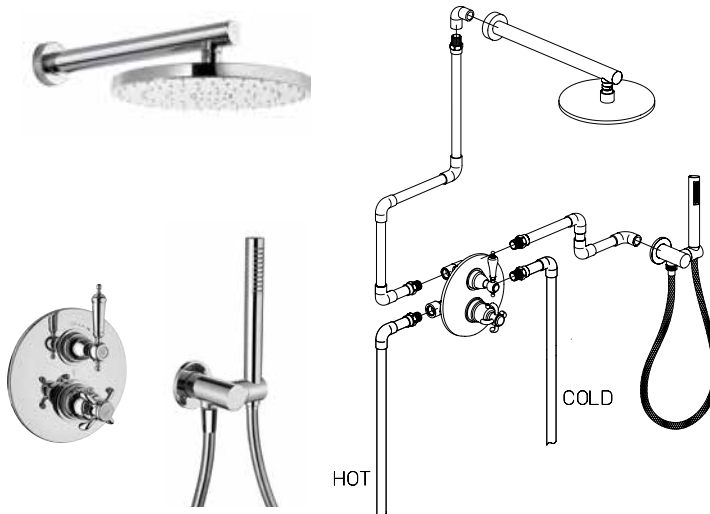

\$782,00	\$999,00	NA
----------	----------	----

RD..74512

\$126,50	\$176,00	NA
----------	----------	----

12" wallmount shower arm with strengthened fixing.

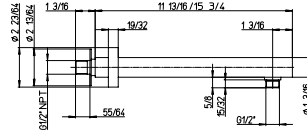
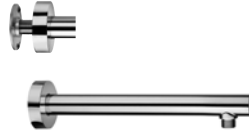
RD..74516

\$137,50	\$187,00	NA
----------	----------	----

16" wallmount shower arm with strengthened fixing.

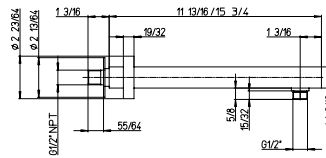
RD..74406

\$71,50	\$93,50	NA
---------	---------	----

6" Ceiling mount shower arm with strengthened fixing.

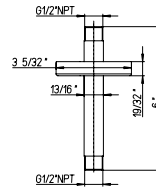
RD..74412

\$104,50	\$137,50	NA
----------	----------	----

12" Ceiling mount shower arm with strengthened fixing.

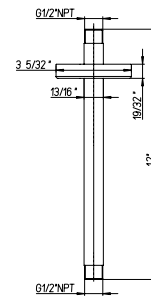
RD..75908

\$99,00	\$126,50	NA
---------	----------	----

Extraslim 8" showerhead only.
Round design.
1/2" connections.

Flow Rate: 1.8 GPM @ 60 PSI MAX

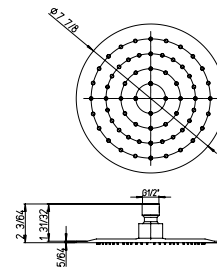
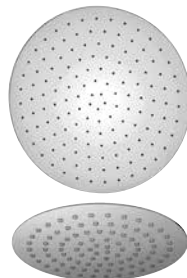

RD..75910

Extraslim 10" showerhead only.
Round design.
½" connections.

Flow Rate: 1.8 GPM @ 60 PSI MAX

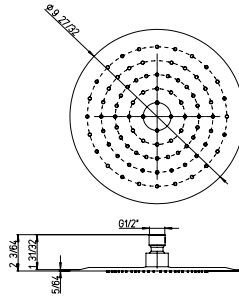
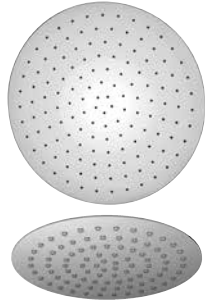

\$126,50	\$154,00	NA
----------	----------	----

RD..75912

Extraslim 12" showerhead only.
Round design.
½" connections.

Flow Rate: 1.8 GPM @ 60 PSI MAX

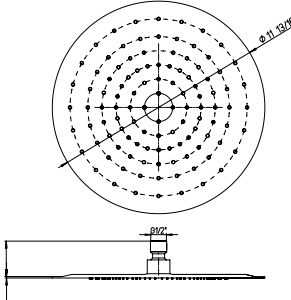
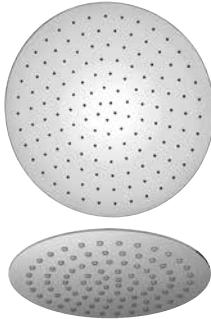

\$154,00	\$181,50	NA
----------	----------	----

78..75908

8" round brass shower head.
Anti-limestone.
½" connections.

Flow Rate: 1.8 GPM @ 60 PSI MAX

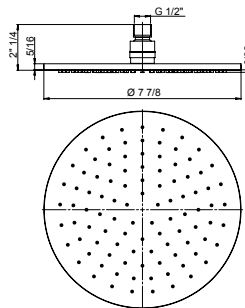

\$173,50	\$231,00	NA
----------	----------	----

78..75910

10" round brass shower head.
Anti-limestone.
½" connections.

Flow Rate: 1.8 GPM @ 60 PSI MAX

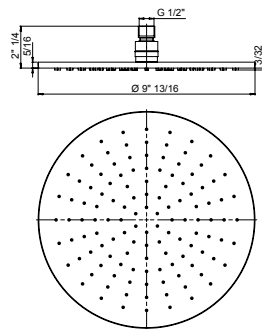

\$242,00	\$330,00	NA
----------	----------	----

78..75912

12 round brass shower head.
Anti-limestone.
½" connections.

Flow Rate: 1.8 GPM @ 60 PSI MAX

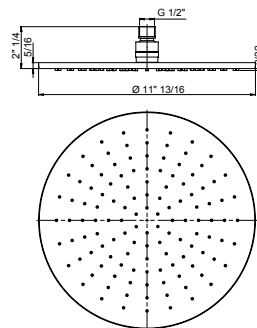

\$385,00	\$522,50	NA
----------	----------	----

RD..129

24" brass slide bar kit.
Includes: Handshower,
Wall mount bracket & supply elbow,
78" flexible hose.

Flow Rate: 1.8 GPM @ 60 PSI MAX

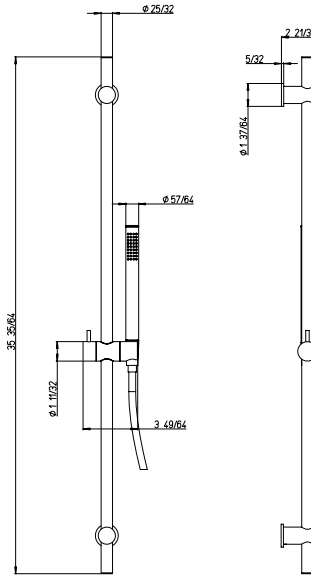

\$330,00	\$467,50	NA
----------	----------	----

RD..440

Wallmounted brass handshower kit.
1-jet hand shower.
Wall mount bracket & supply elbow.
78" flexible hose.

Flow Rate: 1.8 GPM @ 60 PSI MAX

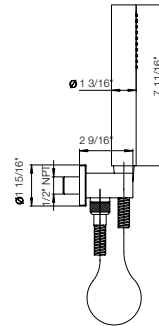

\$192,50	\$247,50	NA
----------	----------	----

50..162

78" metal shower hose.



\$27,50	\$49,50	\$60,50
---------	---------	---------

RD..503

Round brass drop elbow.

1/2" NPT Connection

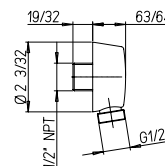

\$38,50	\$60,50	NA
---------	---------	----

RD..721

\$220,00 \$253,00 NA

Round brass body tile spray.
 Directional Body Spray.
 30° Rotation.
 ½" Female NPT Connection.

Flow Rate: 1.5 GPM @ 60 PSI MAX

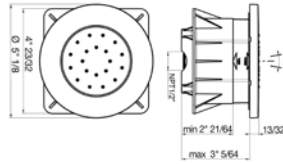

86..721

\$110,00 \$137,50 NA

Round brass body spray.
 Directional Body Spray
 30° Rotation
 ½" Female NPT Connection

Flow Rate: 1.5 GPM @ 60 PSI MAX

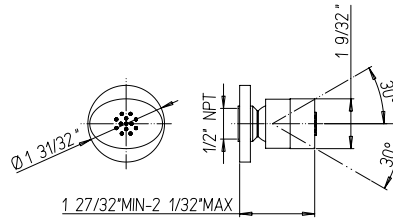

87..430

\$132,00 \$176,00 NA

Brass tub spout wall mount.

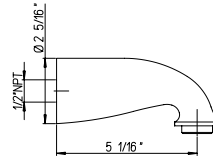

RD..945

\$82,50 \$110,00 NA

Push down pop up drain.

