

ELECTRICAL SAFETY INSTRUCTIONS

All connections must be installed by a licensed electrician, in accordance with current building codes. Consult a qualified electrician.

IMPORTANT

Always switch off the electrical supply at the main during installation and maintenance. It is recommended that the circuit breaker is switched off for the necessary circuit before installation commences.

Fitting in Bathrooms is subject to the appropriate building code Regulations. This product is NOT suitable for outside zones. It is also Not suitable for installation in saunas, steam rooms or shower cubicles. This product is only suitable for permanent installation. **DO NOT** connect to a trailing plug and socket outlet. This product is only suitable for indoor use. Do not attach the product to surfaces that are damp or otherwise electrically conductive.

INSTALLATION CARE & SAFETY

Wear suitable eye protection when drilling. Take care when using power tools. Beware of hidden cables or pipes. Take care if drilling on tiled surfaces in case the drill slips. A piece of masking tape applied to the wall before marking out the fixing holes will stop the drill from wandering.

IMPORTANT

The product must be installed with a minimum distance of 6" between the infrared sensor and an adjacent wall or obstruction to ensure correct function of the sensor.

(See diagram A)

DO NOT strike glass components with hard or pointed items. **DO NOT** place very hot or very cold items against or in close proximity to glass surfaces unless an adequately thick insulation material is

used to prevent such items coming in contact with the glass. The nominal thickness of the mirror glass used in this product is 1/4" and is film backed for safety. If the glass becomes chipped or broken replace immediately.

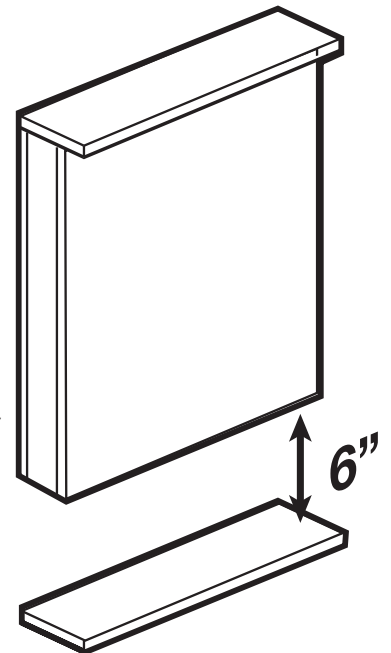

Diagram A

CLEANING

It is recommended that the unit is cleaned with a soft, dry, non abrasive cloth when turned off. Never use cleaning agents or abrasive materials on any type of surface finish. Do not allow moisture to come into contact with the electrical components.



LED ILLUMINATED ALUMINIUM CABINETS

Installation Instructions

Passeo

1. Remove the packaging taking special care with the doors and separate shelves. Open the cabinet doors and remove the screws on the doors. Take care not to lose the screws.

2. Using a level, mark off a horizontal line approximately $2\frac{3}{4}$ " below where the top of the cabinet is to be. Position the bracket hole so that they are centred on the line, and ensure that the ends of the brackets are spaced to the width between the inner edges of the vertical aluminium extrusions (see illustration 1). Mark off the holes using a pencil.

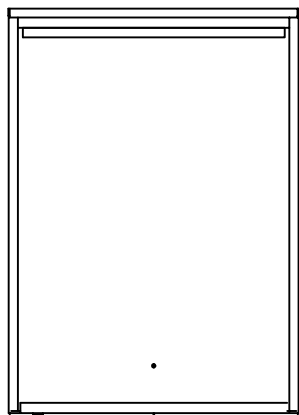
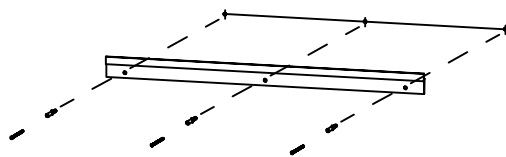

Illustration 1

3. Note: Screws supplied are only suitable for stud walls. For drywall walls use special wall fasteners, available from DIY or hardware stores. Seek advice from a specialist about the suitability of screws to be used. Drill the required holes and insert wall screws.

4. Screw the bracket to the wall using the screws provided. Please ensure the screws are fully tight but take care not to overtighten.



5. Before making any electrical connections it is necessary to turn off the main electricity supply. This unit is provided with a supply cable already fitted. This cable should be fitted to the household lighting circuit or to a fused 3 AMP supply. Connections should be made in accordance with the latest regulations. This cabinet is manufactured to CLASS 1 and requires an earth connection.

6. When the cabinet is fully secure the internal top cover should be closed and secured with the small screws removed earlier. When the cover is closed and secure restore the main power and test the function of the lights and the shaver socket. If the light fails to function properly it is likely the IR sensor has been positioned too close to an adjacent wall or reflective surface

7. Fitting the glass shelves. Firstly insert a shelf into the top two shelf support brackets then slide upwards so the grub screws on the underside of the support brackets (Screw C) can be sufficiently tightened to hold glass in place. Repeat for the bottom shelf (NOTE: be careful not to overtighten). Shelves can be positioned accordingly by sliding the supports up or down (NOTE: Take care to use both hands when sliding shelves and ensure that support brackets at both ends slide simultaneously). Once shelves are in their desired locations turn screw D to secure in position. A level should be used to ensure shelves are level.

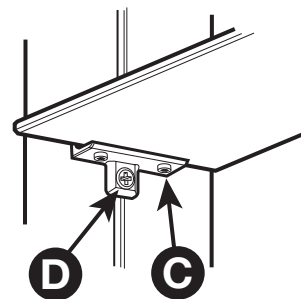

8. If the doors are out of alignment first remove the soft-close buffer (from the relevant hinges) which clips into the main hinge plate. The soft-close hinges offer adjustment in 3 directions via adjustment screws E, F and G (see diagram).

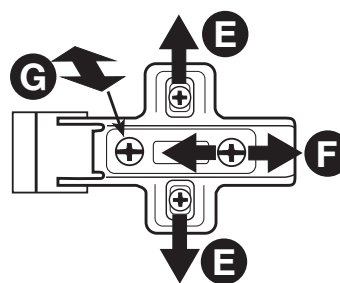
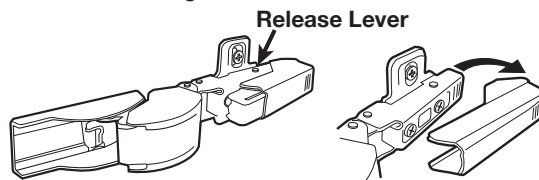

LTL HOME PRODUCTS, INC.

OPERATING INSTRUCTIONS

Light can be controlled by using the IR sensor switch under the cabinet

Installation Instructions:

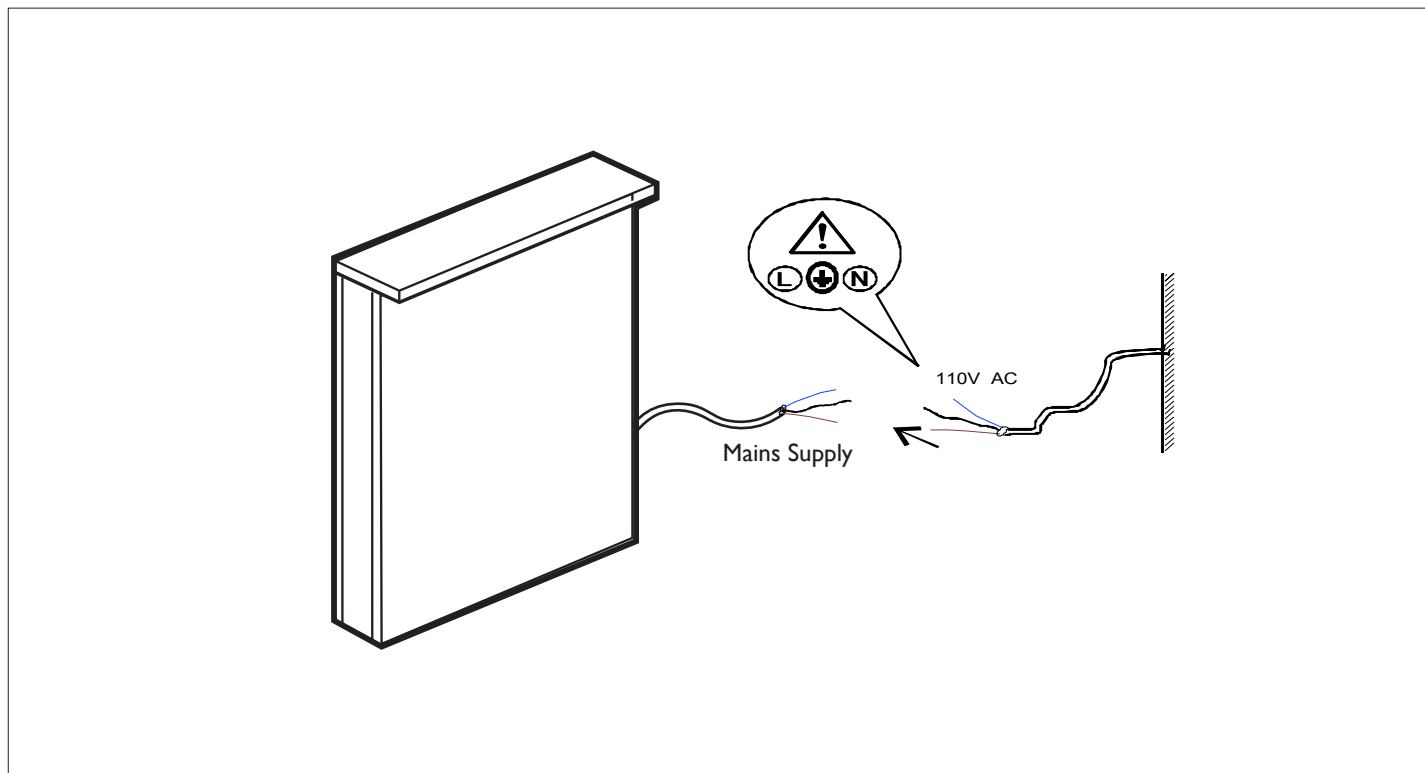

The next step is to make the electrical connection from the mirror to the mains supply. Use the connection wire found at the rear of the mirror to make the necessary connections. A second person will need to hold the mirror in place whilst electrical connections are made.

**THIS PRODUCT IS MANUFACTURED TO CLASS I
CATEGORY AND MUST HAVE AN EARTH CONNECTION.**

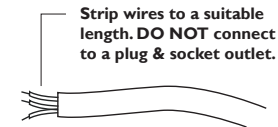
COLOUR CODING: L - Live = Black N - Neutral = White ⊕ - Earth = Green	 <p>Strip wires to a suitable length. DO NOT connect to a plug & socket outlet.</p>
---	---

! IF IN DOUBT CONSULT YOUR ELECTRICIAN !



LTL HOME PRODUCTS, INC.