

## THERMOSTATIC TOUCH PANEL CONTROLLED RECESSED CEILING MOUNT RAINFALL WATERFALL SHOWER SYSTEM WITH HAND SHOWER SPECIFICATIONS

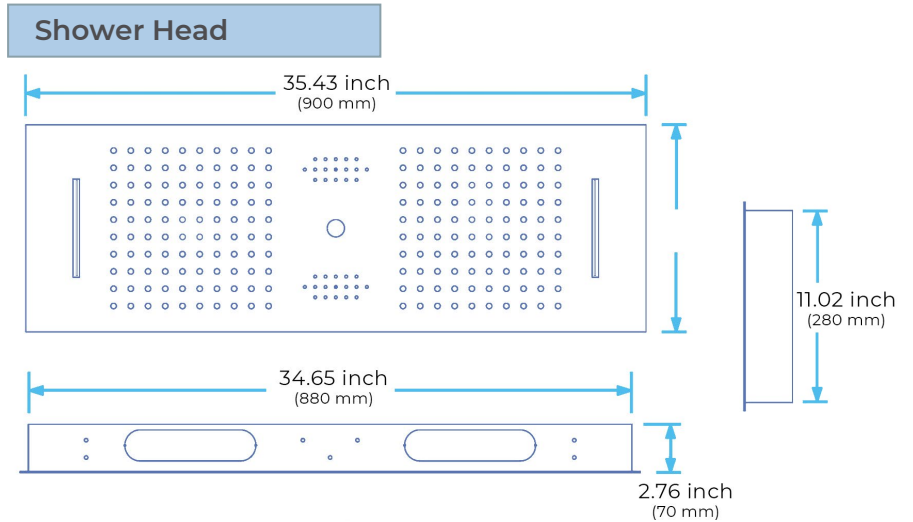

- Shower Panel /Hose Material: 304 Stainless Steel
- Shower Head Size: 900\*300 mm
- Shower Mixer Material: Brass
- Concealed Mixer Size: 465\*130 mm
- Showerheads Install: Embedded Ceiling Mounted
- Concealed Mixer Install: Wall-Mounted
- LED Shower Head Functions: Rainfall, Waterfall, Water Column
- Water Pressure: 0.3 MPA
- Water Flow: 16L/min~28L/min
- Hand Shower/ Shower holder Material: Brass
- Shower Accessories Material: Brass
- LED Light: Need to Connect Power
- LED Light Color: 64 Color
- Shower Hose Length: 1.5M
- AC: 100-265V 50/60Hz

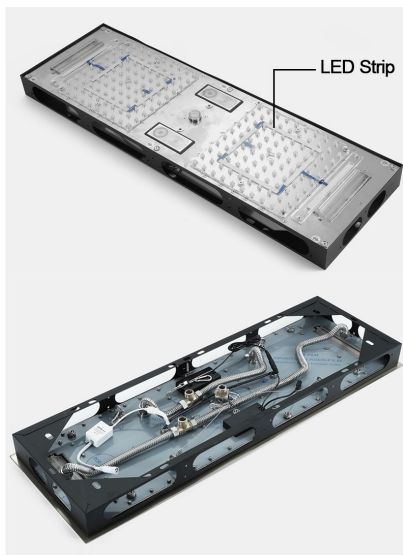

### Touch Panel Control

- Turn On/Off Control
- MANUAL MODE**  
Total 64 colors
- Auto mode setting
- AUTO MODE**  
Total 11 Auto mode
- Set the speed of color change, fast/slow

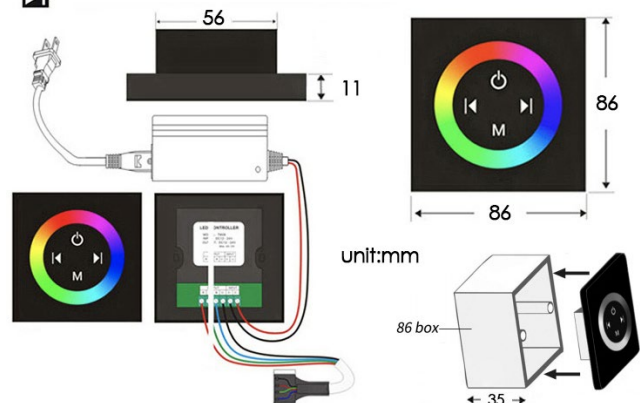

All dimensions and specifications are nominal and may vary. Use actual products for accuracy in critical situations.

## Shower Mixer



**38°C**  
Thermostatic Control

Main body  
Brass casting body



Brushed gold

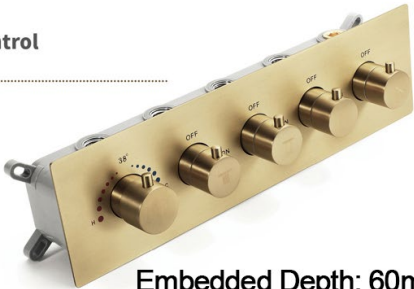

Embedded Depth: 60mm



Product shown is only for installation display purpose

All functions can be used at the same time.

Spin button change water flow size.

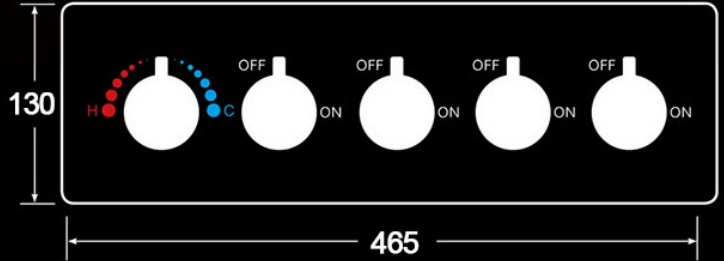

Thread have G 1/2" and NPT 1/2"

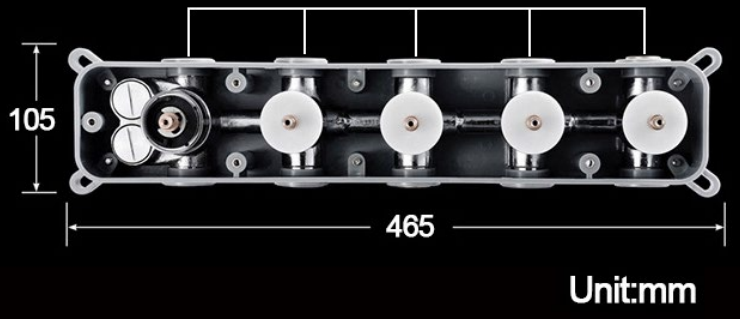

## Hand Shower

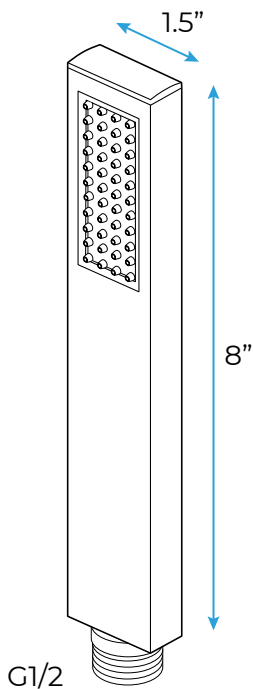

Flow Rate: 2.0 GPM / 7.6 LPM

## Shower Mixer Connections

