

# TOTO

--

- You are advised to record the following information to allow quick service.

Date of purchase :	Name of shop :
Date : year month day	Tel : (     )

2020.10.1  
D07869

# TOTO

## WASHLET

Instruction Manual



### washlet®

SW3084T40  
SW3084

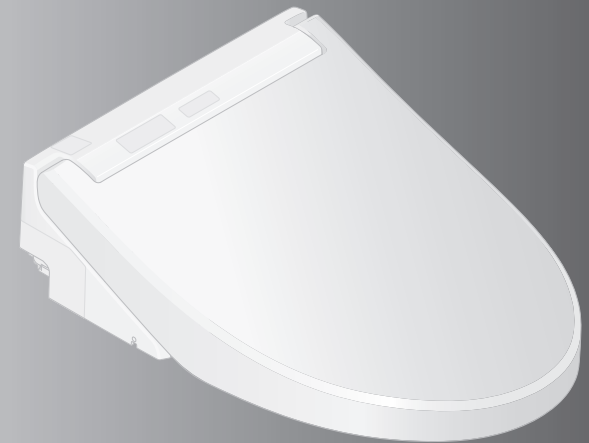

- Thank you for your recent purchase of this product.  
Please read the enclosed information to ensure the safe use of your product.
- Be sure to read this Instruction Manual before using your product and keep it in a safe place for future reference.

# What functions are available on your product?

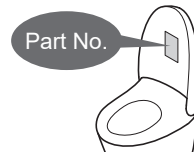

# Keep It Clean Sanitary Toilet



The self-cleaning functions operate automatically.  
(See page 16 for details.)

	As you sit	As you stand up
Removing odors inside the bowl unit.	Deodorizer	Auto power deodorizer
A mist is automatically sprayed inside the bowl unit to make it more difficult for dirt to adhere.	Pre-mist	
Cleans the wand with "EWATER+"		Auto wand CLEAN

Product name (Model)		WASHLET		Ref. Page
Functions	Part No.	SW3084T40 SW3084		
Basic Functions	Cleansing	Rear cleansing	●	18
		Rear soft cleansing		
		Front cleansing		
	Changing the cleansing method	Wand position adjustment	●	
		Water pressure adjustment		
		Oscillating cleansing		
		Pulsating cleansing		
		Personal setting lock		
	Drying	Warm air drying	●	
	Changing the temperature	Temperature adjustment	●	
Sanitary Functions	Removing odors	Deodorizer	●	16
	"EWATER+" cleaning	Auto wand CLEAN	●	
	Bowl pre-cleaning	Pre-mist	●	
Convenience Functions	Heating the toilet seat	Heated seat	●	-
	Saving energy	Auto energy saver	●	22, 23
		Timer energy saver	●	
Maintenance		Main Unit One-touch removal	●	34, 35
		Removable toilet lid	●	33
		Wand cleaning	●	36

## Table of Contents

Safety Precautions.....	4	Introduction
Operational Precautions .....	11	
Parts Names .....	12	
Preparation .....	14	

Basic Operations.....	16	Operation
●Mechanism of Auto Functions ...	16	
Deodorizer, Auto wand CLEAN, Pre-mist		
●Using the Remote Control... ..	18	
Temperature Adjustment (Toilet Seat, Warm Water, Drying).....	20	
Energy Saver Features .....	22	
Various Operations .....	26	
●Setting List .....	26	
●Auto functions .....	28	
●Other settings.....	30	

Maintenance .....	31	Maintenance
●Power Plug .....	31	
●Main Unit .....	32	
●Gap between the Main Unit and the Toilet Lid .....	33	
●Gap between the Main Unit and Bowl Unit .....	34	
●Deodorizing Filter .....	36	
●Wand .....	36	
Wand cleaning		
●Water Filter Drain Valve .....	37	

What to Do?.....	38	Reference
●If the water does not flow due to a water service interruption .....	38	
●If you cannot operate with the remote control .....	38	
●Freeze Damage Prevention ..	39	
●Long Periods of Disuse .....	40	
●Removal of Operation Guide ..	41	
Troubleshooting.....	42	
Specifications .....	46	
Limited Warranty .....	47	

# Safety Precautions

## IMPORTANT SAFEGUARDS



READ ALL INSTRUCTIONS BEFORE USING

### Symbols and Meanings

 **WARNING** May result in death or serious injury.

 **CAUTION** May result in injury or property damage.

The following symbols are used to indicate important safety instructions for the use of the product.

Symbol	Meaning
	This symbol indicates a prohibited use of the product.
	This symbol is used to indicate a required step in the use of this product.

## WARNING

### Do not plug or unplug the power plug with wet hands.

- Doing so may cause electrical shock.

### Do not get any water or cleaning solution on the main unit or power plug.

- Doing so may cause fire, electrical shock, heat or short circuit.
- Doing so may cause the product to crack resulting in injury or water damage.

### Never disassemble, repair or alter.

Doing so may cause fire, electrical shock, overheating, short circuit or breakdown.

### Do not install the product on moving vehicles such as wheeled vehicles or boats.

- Doing so may cause fire, electric shock, short circuit or malfunction.
- The toilet seat, toilet lid, main unit, or other parts may come loose and fall off, resulting in injury.

### Do not use the product if a malfunction occurs.

- In case of breakdown or other problem, be sure to cut off power by means such as unplugging the power plug.

Close the water shutoff valve to stop water supply.

Possible malfunctions:

- Water is leaking from a pipe or the main unit.
- The product is cracked or broken.
- The product makes a strange noise or emits a strange odor.
- The product emits smoke.
- The product is abnormally hot.
- The toilet seat cushion is out of place.

- Continued use after malfunction could cause a fire, electric shock, heat, short circuit, injury or water damage.

## WARNING

**Do not use other water than allowed by the laws and ordinances of the region of use. Only Use drinking water.**

**Do not use seawater or recycled water.**

- Doing so may cause irritation to the skin and malfunction.

**Do not touch the power plug during thunderstorms.**

- Doing so may cause electrical shock.

**Do not allow the water supply hose to touch the power plug or outlet.**

- Doing so may cause condensation resulting in a fire, electrical shock, heat or a short.

**Do not do anything that may damage the power cord, power plug.**

**Do not strike, yank, twist, excessively bend, damage, alter, or heat the power cords. Also, do not place anything heavy on, bind or pinch the power cords.**

- Using a damaged power cord may result in a fire, electrical shock, heat or short.

**Do not use a loose or faulty electrical outlet.**

- Doing so may cause fire or short circuit.

**Do not use any outlet or wiring equipment beyond its specified rating.**

- Plugging too many plugs into the same outlet, for example using outlet splitters, can cause fire due to heat.



**Do not use any power supply other than the one specified.**

AC 120 V, 60 Hz

- Doing so may cause fire or excessive heat.

**Do not stick a finger or anything else into the warm air outlet.**

**Do not place anything on the warm air outlet or drape clothes over it.**

- Doing so may cause burns, electrical shock or malfunction.

**Keep cigarettes and other open flames away from the product.**

- Failure to do so may cause fire.

**Refrain from sitting on the seat for long periods.**

- It may cause low-temperature burns.

To prevent the following persons from getting a moderate temperature burn during use, other person should turn off the toilet seat heater.

- Young children, the aged and other users unable to set the temperature appropriately themselves.
- The ill, physically disabled and others who do not have freedom of movement.
- Those using any medicines that cause drowsiness (sleeping or cold medicine), those who have been drinking heavily, anyone severely fatigued and anyone else liable to fall asleep.

# Safety Precautions (Continued)

## WARNING

**This is an electrical product. Do not install it anywhere water is likely to get on the product or anywhere with humidity high enough that water is likely to form on the surface of this product. When using the product in a bathroom, install a fan or ventilation port and ensure good air flow through the bathroom.**

- Failure to do so may cause fire or electrical shock.

**Always connect the product to the cold water supply.**

- Connecting to hot water supply may result in burns and equipment damage.

**Make sure that a properly grounded (3 prong) outlet has been installed.**

- Failure to install a grounded outlet could cause electrical shock in the event of a malfunction or short circuit.

**Insert the power plug securely into the outlet.**

- Failure to do so may cause fire, heat or short circuit.

**To unplug, hold the power plug, not the power cord.**

**Do not unplug by pulling the power cord.**

- Pulling on the power cord may cause damage and result in fire or heat.

**If the power cord is damaged, avoid danger by having the manufacturer's repair department or equivalent specialist replace it.**

**Always unplug the power plug from the outlet before maintenance or inspection.**

- Failure to do so may cause electrical shock or malfunction.

**Periodically remove dust and dirt from the power plug and make sure it is securely plugged into the wall outlet.**

- Failure to do so may cause fire, heat or short circuit.

Pull the power plug out from the outlet and wipe clean with a dry cloth.

**Always unplug the power plug from the outlet before removing the main unit.**

- Failure to do so may cause fire or electrical shock.

**When leaking battery fluid adheres to your body or clothes, wash it away with clean water.**

- The fluid may damage your eyes or skin.

**Preliminary studies in females suggest that overuse of continuous spraying can increase the possibility of vaginal mucosa drying and potential reduction in desirable microbial organisms.**

**Although these studies have not been validated, please consult your healthcare provider for concerns regarding whether these circumstances may apply to you.**

**More importantly, if you are an individual suffering from any immune deficiency as a result of disease, chemotherapy, or other medical condition compromising the immune system you should consult your healthcare provider before use of this product.**



## CAUTION

**Do not use the product if the main unit is unstable.**

- Doing so may cause the main unit to come loose and fall, resulting in injury.

**If the product is damaged, do not touch the damaged section.**

- Doing so may cause electrical shock or injury.

Replace it immediately.

**Do not apply strong force, mechanical shock, step on or stand on the toilet seat, toilet lid or main unit. Also do not place any heavy object on the toilet seat, toilet lid or main unit.**

- Doing so may cause cracking or cause the main unit to come loose and fall, resulting in injury.
- Doing so may damage the product and cause injury or water damage.

**Do not lift up this product by the toilet seat or lid.**

**Do not raise the toilet seat or lid while objects are resting on top of the unit.**

- Doing so may cause the main unit to come loose and fall, resulting in injury.

**When maintaining the plastic parts (main unit etc.) or the water supply hose, use a neutral kitchen detergent diluted with water. Do not use any of the following.**

**Toilet cleaner, household cleaner, benzene, paint thinner, powdered cleanser or nylon scrubbing brush.**

- These items may damage or crack the plastic and cause injury or malfunction.
- These items could damage the water supply hose and cause a water leak.

**To prevent a sudden water leak, do not remove the water filter drain valve when the shutoff valve is open.**

- Doing so will cause water to spurt out.

(Refer to Page 37 for instructions on cleaning the water filter drain valve.)

**Do not fold or crush the water supply hose; do not damage by cutting with a sharp object.**

- Doing so may cause water leaks.

**Do not install the base plate, which is not attached.**

- Doing so may cause damage.



# Safety Precautions (Continued)

## CAUTION

**If a water leak should occur, always close the shutoff valve.**

**When the ambient temperature is likely to drop to 32 °F (0 °C) or lower, prevent damage to the pipes and hoses due to freezing.**

- Frozen water pipes could cause the main unit and the pipes to break, resulting in a water leak.
- Regulate the room temperature to prevent the pipes and hoses from freezing during cold months.
- Drain the water.

**When not using the product over an extended period of time, drain the water out of the main unit and the water supply hose after closing the water shutoff valve, and pull the power plug from the outlet.**

- When using the product again, allow the product to refill with water first. Otherwise, the water in the tank might become contaminated and cause skin inflammation or other problems. (Refer to Page 40 for instructions on replenishing the water.)
- Leaving the power on may cause fire or heat.

**When installing the water filter drain valve, make sure that it is securely tightened in its proper position.**

- Failure to securely tighten it may cause a water leak.

**Push the main unit securely on to the base plate.**

- After pushing the main unit until a click sound is heard, pull it slightly toward you to make sure that the product does not detach.
- Doing so may cause the main unit to come loose and fall, resulting in injury.

**Make sure of the plus and minus signs on the batteries before inserting them. Remove depleted batteries immediately.**

**When replacing the batteries:**

**Replace both batteries with new ones.**

**Use the same brand for both new batteries (any brand available).**

- Failure to do so may cause the batteries to leak fluid, generate heat, rupture, or ignite.

**When the product is supposed not to be used for long time, remove the batteries from the remote control.**

- Failure to do so may cause the batteries to leak fluid.

## DANGER To reduce the risk of electrocution:

1. Do not use while bathing.
2. Do not place or store the product where it can fall or be pulled into a tub or sink.
3. Do not place in or drop into water or other liquid.
4. Do not reach for the product when it has fallen into water. Unplug it immediately.

## WARNING To reduce the risk of burns, electrocution, fire or injury to persons:

1. Close supervision is necessary when this product is used by, on, or near children or invalids.
2. Use this product only for its intended use as described in this manual. Do not use attachments not recommended by the manufacturer.
3. Never operate this product if it has a damaged cord or plug, is not working properly, has been dropped or damaged, or has been dropped in water. Return the product to a service center for examination and repair.
4. Keep the cord away from heated surfaces.
5. Never block the air openings on the product or place it on a soft surface, such as a bed or couch, where the air openings may be blocked. Keep the air openings free of lint, hair, and other similar items.
6. Never use while sleepy or drowsy.
7. Never drop or insert any object into any opening or hose.
8. Do not use outdoors. Do not operate where aerosol (spray) products are being used or where oxygen is being administered.
9. Connect this product to a properly grounded outlet only.  
See "Grounding Instructions" in Page 10.
10. The tank should be filled with water only.

- Servicing should be performed by an authorized service representative.
- This product is for household use.

# Safety Precautions (Continued)

## Grounding Instructions

This product should be grounded. In the event of an electrical short circuit, grounding reduces the risk of electric shock by providing an escape wire for the electrical current.

This product is equipped with a cord having a grounding wire with a grounding plug.

The plug must be plugged into an outlet that is properly installed and grounded.

**⚠ DANGER** - Improper use of the grounding plug can result in a risk of electric shock. If repair or replacement of the cord or plug is necessary, do not connect the grounding wire to either flat-head terminal.

Check with a qualified electrician or serviceman if the grounding wire instructions are not completely understood, or if in doubt as to whether the product is properly grounded.

**SAVE THESE INSTRUCTIONS**

# Operational Precautions

## ■ For prevention of malfunctions

- Do not block the remote control transmitter or receiver.

### <About the seat switch>

- When you sit on the toilet seat, the seat switch turns ON, enabling you to use various features. (A click sound is heard when the seat switch is ACTIVATED.)

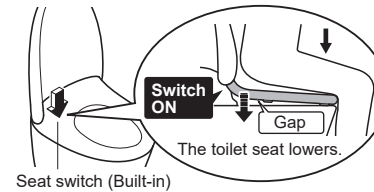

- Sit back on the toilet seat.
  - The seat switch will not turn on unless you sit on the seat properly.



### Note

- When a child uses the product, the seat switch may not be ACTIVATED by their light body weight.
- Since the toilet seat is designed to move up and down, a clearance is provided between the toilet seat cushion and the bowl unit.

## ■ For prevention of damage

- Wipe plastic areas such as the main unit and remote control with a soft cloth tightly wrung out with water.

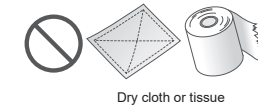

- Do not lean against the toilet lid.



## ■ For prevention of malfunctions and failures

- Disconnect the power plug if there is a risk of lightning.
- A toilet seat cover or a toilet lid cover cannot be used. (The seat switch may not function properly. Additionally, the toilet seat and lid may not open or close properly.)
- Do not urinate on the main unit, toilet seat or wand. (Doing so may cause a failure or discoloration.)
- Do not apply strong forces to the control panel of the remote control.
- When using a toilet cleaner to clean the toilet, rinse it off within 3 minutes and leave the toilet seat and toilet lid open. (If vapor from a toilet cleaner enters the main unit, it may cause a malfunction.)
  - Wipe off any cleaner that remains on the bowl unit.
- Do not use the product with the toilet lid removed.
- Do not expose to direct sunlight. (Doing so may cause changes in color, irregular heated seat temperature, remote control malfunction or the product malfunction due to the change in temperature.)
- Use radios, etc. away from the product. (The product could cause interference with the radio signal.)
- If you use a booster seat for infants or a soft highchair, remove it after use. (Keeping it installed may prevent some of the functions from being used.)
- Do not apply force to the remote control. (May cause malfunction.)
  - To prevent the remote control from being dropped, set it in the hanger when you are not using it. Be careful not to expose it to water.
- Do not place anything on the toilet seat and lid, and do not press them with hands. (Failure to do so may turn on the seat switch, causing the floor to get wet if buttons on the remote control are touched and warm water comes out from the wand.)

# Parts Names

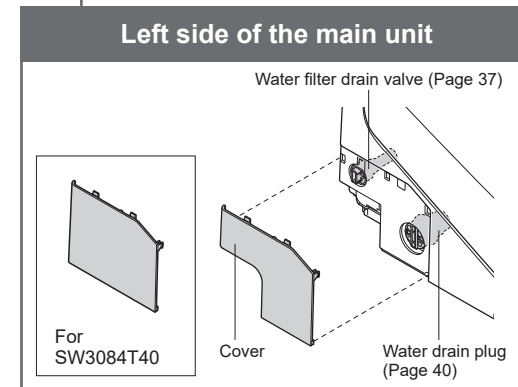
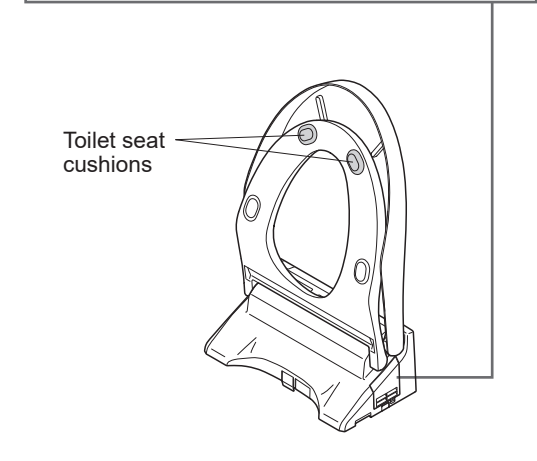
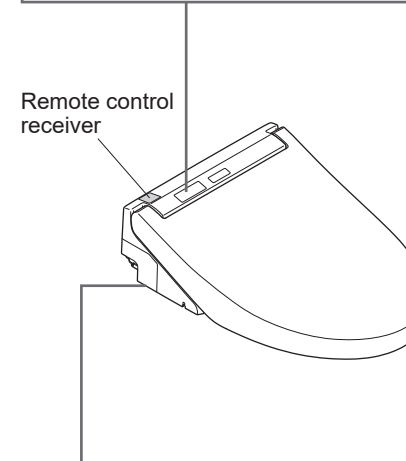
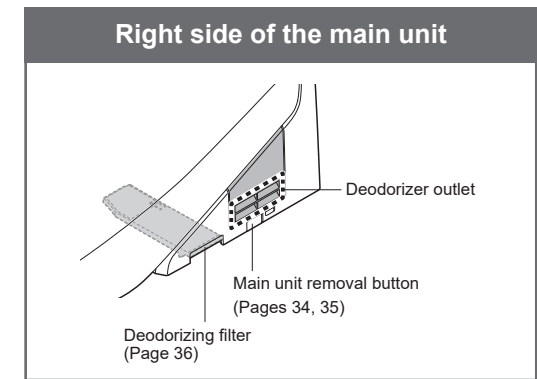
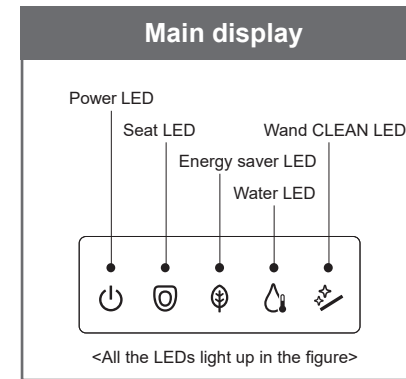
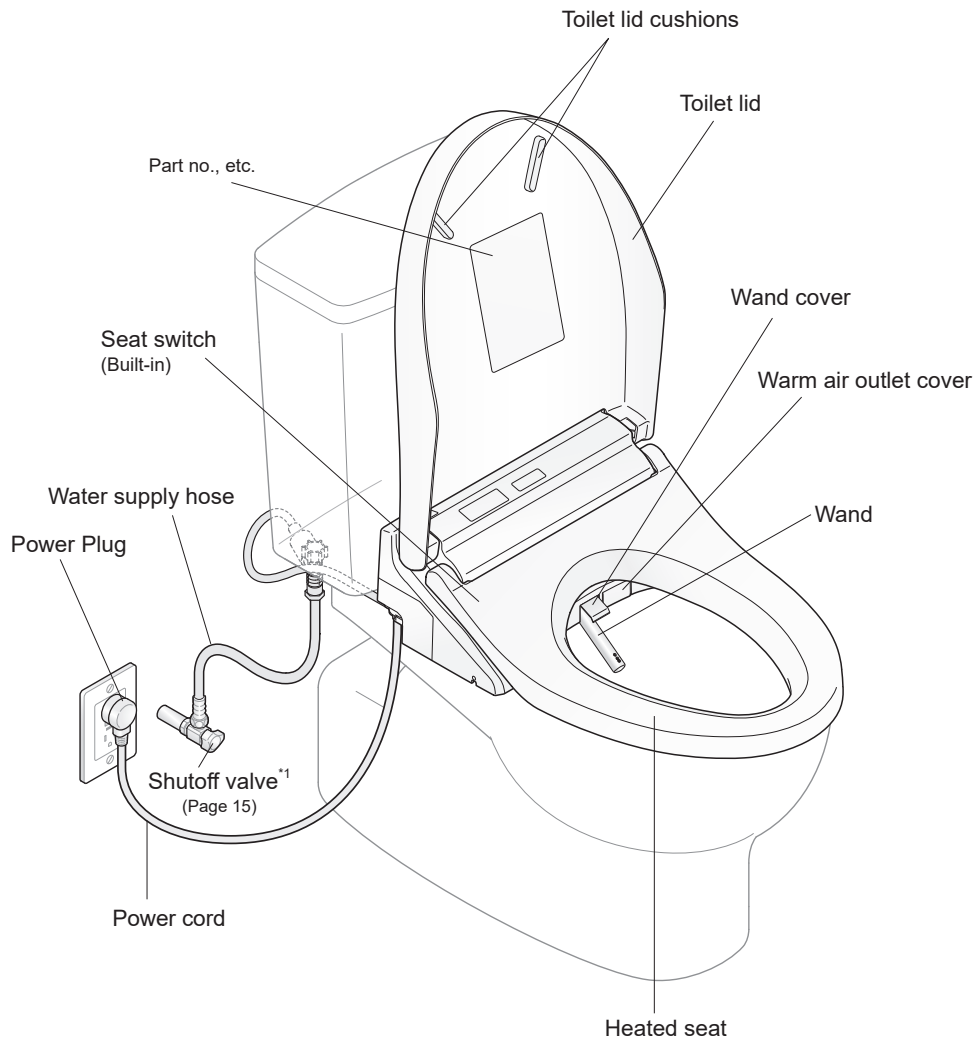

Descriptions in this manual are based on the illustrations of SW3084  
 \*1 The shape and location vary depending on the type of toilet bowl and tank.

# Preparation

## Using the Product for the First Time

### 1. Insert the battery

- 1 Remove the remote control from the hanger.

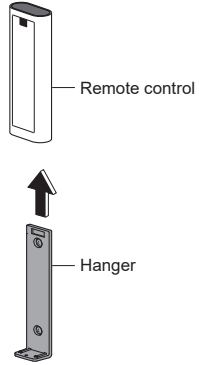

- 2 Open the battery cover and insert two AA batteries.

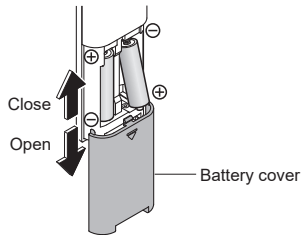

- When batteries are properly loaded, all the LEDs on the remote control light up for about 2 sec.

- 3 Mount the remote control in the hanger.

#### ■ About the batteries

- Use dry cell, alkaline batteries.
- Be sure to follow "Safety Precautions" to prevent the batteries from rupturing or leaking fluid. (Pages 6, 8)

### If the remote control is secured (for anti theft)

- 1 Remove the screw from the remote control fixture.

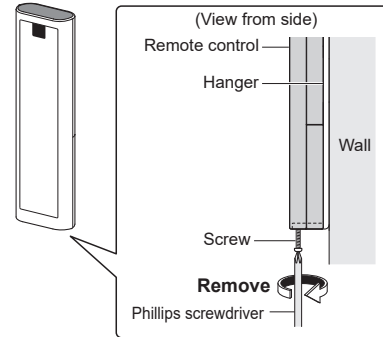

- 2 Remove the remote control from the hanger.

#### ■ To secure the remote control again

- Tighten and fix the screw. (Overtightening may cause damage to parts such as the hanger.)

### 2. Turn on the power

- 1 Insert the power plug.
  - The wand extends and then retracts.
- 2 Check that the "Power" LED lights up.

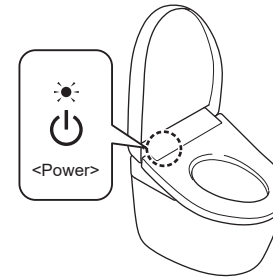

<If the light is off>

- Switch "Power" to "ON" using the remote control.

#### To operate from the back of remote control

- ⏻ Press "Power ON/OFF" button about 3 seconds or longer.

#### To operate from the front of remote control

- Recommended if the remote control is secured to prevent theft, etc.
  - Press "Oscillating cleansing" button about 10 seconds or longer.

### 3. Open the shutoff valve

- 1 Fully open the shutoff valve.

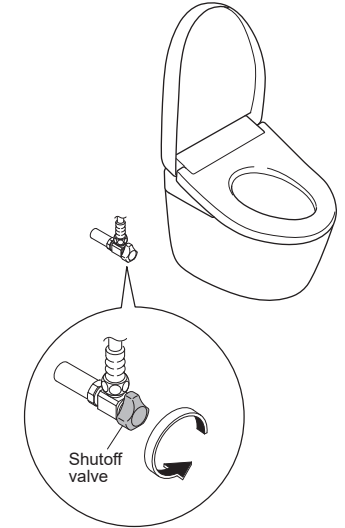



# Basic Operation

## Mechanism of Auto Functions

"EWATER+" is used automatically to clean the wand.

As you approach

As you sit

As you stand up \*1

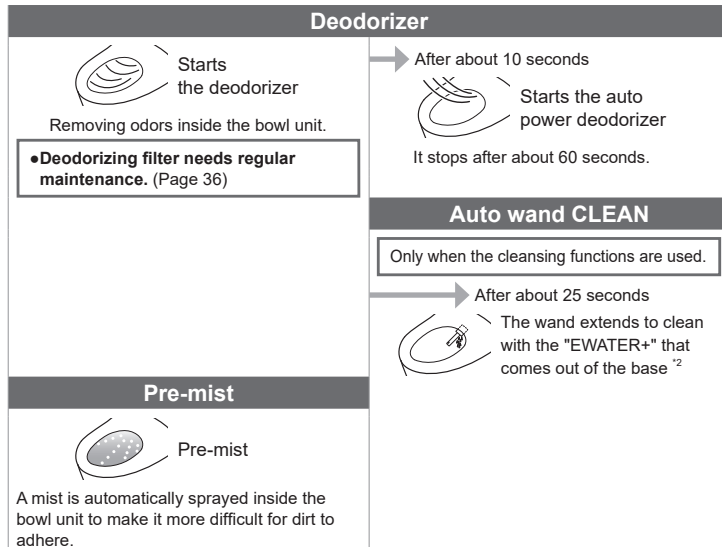

\*1 To keep clean the wand every time it is used, water remaining in the wand is drained after you stand up from the toilet seat.  
\*2 When the cleansing functions (Rear cleansing and Front cleansing etc.) have not been used in 8 hours, the wand is cleaned automatically. (Water comes out from around the wand.)

The left are default setting functions.

- These may be changed. → "Various Operations" (Pages 26-30)

### Auto wand CLEAN

During "Auto wand CLEAN" or "Wand CLEAN"

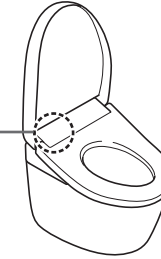

### What is meant by "EWATER+" ?

"EWATER+" helps the self-cleaning wand feature working effectively and preventing the dirt accumulation causing the stains.

- "EWATER+" is generated from Potable water.
- "EWATER+" helps to minimize dirty surfaces, but does not make cleaning unnecessary.
- The effect and duration vary depending on the usage environment and conditions.

"EWATER+" can also be used by pressing the remote control button.

■ Wand



Press "Wand CLEAN" button



(After wand cleaning, water comes out from around the wand.)

- To clean the wand with it extended. ⇒ "Wand cleaning" (Page 36)

# Basic Operation

## Using the Remote Control

Operate the controls on the remote control; a beep sounds when the main unit receives the signal.

**Stopping**

- "Stopping" Stops the operation.

**Cleansing**

- "Rear cleansing" Cleanses your rear.
- "Rear soft cleansing" Cleanses your rear with mild water pressure.
- The setting changes between [Rear cleansing icon] and [Rear soft cleansing icon] each time the [Rear cleansing icon] is pressed.
- "Front cleansing" Serves as a bidet for ladies.

**Drying**

- "Warm air drying" Dries your rear.

**"Wand CLEAN"**

Cleans the wand with "EWATER+".

- The wand can be automatically cleaned when you use the cleansing functions (Rear cleansing, Front cleansing, etc.). (Page 16)

**"Personal setting lock"**

You can store your preferred "Wand position", "Water pressure" and "Warm water temperature" settings.

- To store a settings While cleansing is in progress, set your preferred "Wand position", "Water pressure" and "Warm water temperature" and then press and hold [1] or [2] for 2 seconds or longer.
- To use Press [1] or [2], and then press the button for the cleansing you want to use.
- The "Wand position" and "Water pressure" lamps will light up for about 10 seconds in their set positions, and the "Water temperature" display switches.

**Functions that operate when a button is pressed during "Rear cleansing", "Rear soft cleansing" or "Front cleansing" cleansing.**

**Note**

- Sitting back on the toilet seat makes it easier to adjust the wand position and to reduce splashing.
- "Oscillating cleansing" The wand moves back and forth to cleanse your rear thoroughly.
- "Pulsating cleansing" Cleanses with the water pressure pulsating between soft and strong.
- The setting changes between "ON" and "OFF" each time the button is pressed.

**"Water pressure adjustment"**

You can adjust the water pressure to one of five levels. ([-] Softer, [+] Stronger)

- After you press the "Water pressure adjustment" button, the set position will light for 10 seconds.

**"Wand position adjustment"**

You can adjust the washing position to 5 different points between the front and the rear, using the [▲] and [▼] buttons.

- After you press the "Wand position adjustment" button, the set position will light for 10 seconds.
- It will return to the 3rd position for a while (not exceeding a maximum of 5 minutes) once operation of the remote control has finished.

This section is an overview of the settings that can be configured with the remote control. See the corresponding pages for the detailed descriptions.

**Temperatures**

Adjust temperatures (Page 20)

- "Toilet seat temperature"
- "Warm water temperature"
- "Drying air temperature"

**Energy saver**

Saving energy (Page 24, 25)

- "Timer energy saver"
- "Auto energy saver"

**"Setting confirmation"**

- The current setting can be discerned from the LEDs.

**"Wand cleaning"**

- To clean the wand with it extended. (Page 36)

**Low battery warning mark** (Page 38)

**"Power ON/OFF"**

Pressing it about 3 seconds or longer turns the power on/off.

- If the remote control is secured to prevent theft (Page 15 2-2)

**Remote control back side**

**For your information**

- Water may sometimes come out from around the wand when it expands in the warm water tank, but this is normal.
- As the warm water tank of hot-water system is used, the temperature of warm water may become lower if it is continuously consumed.

\*1 Remote control transmitter (Front side, Top side)

# Temperature Adjustment Toilet Seat, Warm Water, Drying

Three different temperature levels (High, Medium, Low) and "OFF" setting can be made.

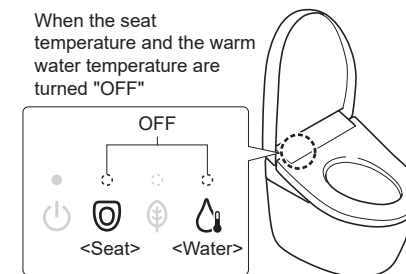
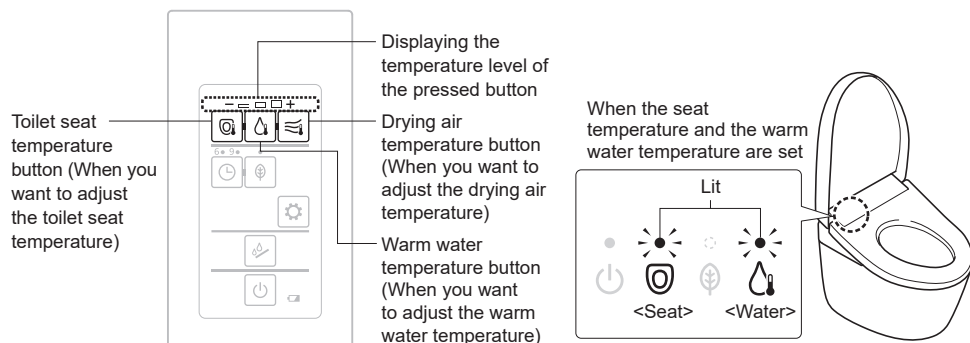

## Adjusting the temperature

- 1** Remove the remote control from the hanger.
  - If the remote control is secured to prevent theft (Page 14)
- 2** Choose and press the button of the temperature that you want to set from the ("Toilet seat temperature" button), ("Warm water temperature" button) and ("Drying air temperature" button).
  - The current temperature level appears.
- 3** Press the button selected in step 2 repeatedly until a desired temperature level lights up.

The setting changes each time the button is pressed once

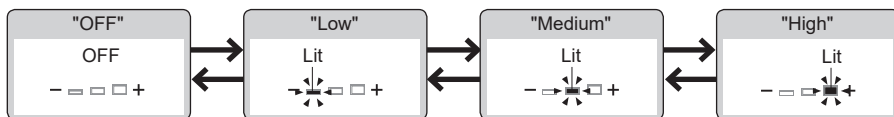

• The "Drying" cannot be turned "OFF".

If the button is not pressed for about 10 seconds, the "Temperature adjustment" LED will go off, but the setting will be retained.  
If the "Temperature adjustment" LED goes out before the setting is completed, start all over again at step 2.

<Settings complete>

- 4** Mount the remote control in the hanger.
  - If the remote control is secured to prevent theft (Page 14)

● When the toilet seat does not get warm, or when the warm water is not warm enough, even after temperature adjustment.

→ Is the "Energy saver" set to "ON"? (Page 22, 23)

## To turn the warm water temperature and toilet seat temperature "OFF"

● The "Drying" cannot be turned "OFF".

- 1** Remove the remote control from the hanger.
  - If the remote control is secured to prevent theft (Page 14)
- 2** Select a temperature button you want to turn "OFF" from ("Toilet seat temperature" button), ("Warm water temperature" button) and press it.
  - The current temperature level appears.
- 3** Press the button selected in step 2 repeatedly until the temperature level is set to "OFF".

The setting changes each time the button is pressed once

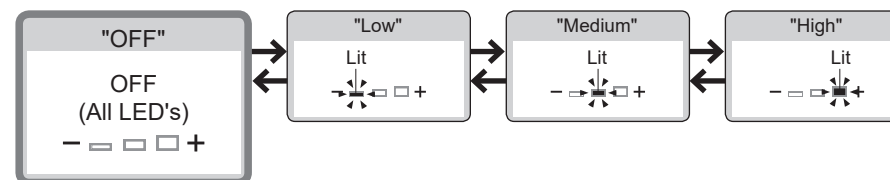

<Settings complete>

- 4** Mount the remote control in the hanger.
  - If the remote control is secured to prevent theft (Page 14)

# Energy Saver Features Type

"Auto energy saver" or "Timer energy saver" can be selected.  
To save energy, lower (or turn "OFF") the seat or warm water temperature.

	You want the product to save energy automatically.	You want to save energy only for the preset duration of time. (6 hours, 9 hours)
	<b>Auto energy saver</b>	<b>Timer energy saver</b>
	The product detects time periods with infrequent use and lowers the toilet seat temperature automatically. ● It takes about 10 days for the product to determine the periods when it is used relatively less frequently.	Once the time is set, the toilet seat heater and warm water heater will be turned off automatically every day at that same time.
<b>When energy saver is in operation</b>		
<ul style="list-style-type: none"> <li>■ Main display</li> <li>■ Toilet seat heater</li> <li>■ Warm water heater</li> </ul>		
<b>Example</b>	<p>When used infrequently from 9 pm to 6 am</p>	<p>When set from 8 am to 5 pm</p>

You want to save energy any way possible
<b>Timer energy saver + Auto energy saver</b>
When both "Timer energy saver" and "Auto energy saver" are set, "Auto energy saver" operates when "Timer energy saver" is not operating.
<ul style="list-style-type: none"> <li>● During "Auto energy saver": Same LED indication as "Auto energy saver"</li> <li>● During "Timer energy saver": Same LED indication as "Timer energy saver"</li> </ul>
"/>
<p>When "Timer energy saver" and "Auto energy saver" are used together</p>

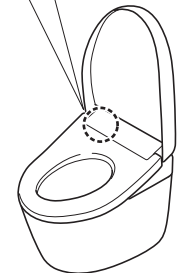
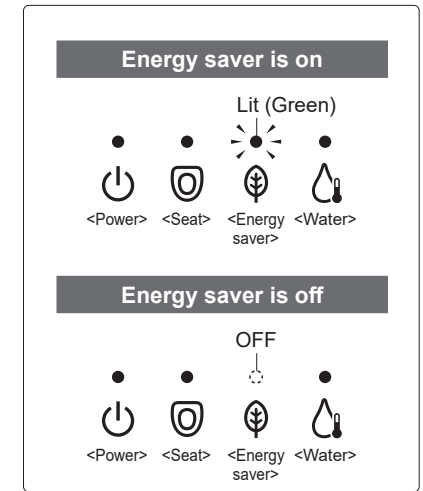

● Even if the energy saver is being activated (with the toilet seat heater set to "Low" or "OFF," or with the warm water heater set to "OFF"), the toilet seat will be temporarily heated when you sit on it. (To reach the setting temperature, the toilet seat takes about 15 minutes and the warm water about 10 minutes, respectively.) (The LED indication on the main display returns to the state for when the energy saver is on.)

\*1 The toilet seat temperature set on pages 20, 21.  
\*2 The time period when the toilet seat heater is set to a "Low". The warm water heater is "Set temperature".  
\*3 The time period when the toilet seat heater and warm water heater are "OFF".

To set energy saver Page 24 and 25

# Energy Saver Features How to Set

Remote control back side

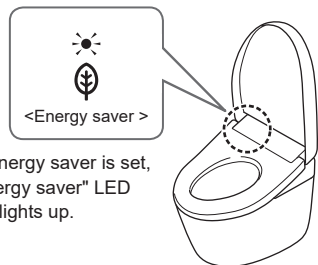
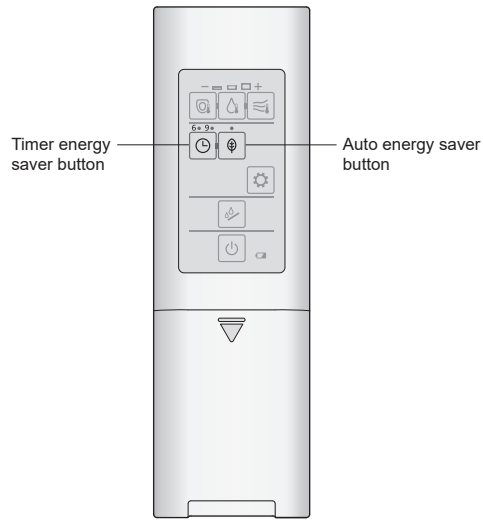

When energy saver is set, the "Energy saver" LED (green) lights up.

## Auto energy saver

- 1  Press "Auto energy saver" button.

The setting changes each time the button is pressed once

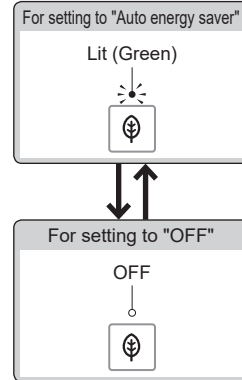

<Settings complete>

## Timer energy saver

- Set the Energy saver at the time you want to start it.  
Example: To save energy from 1 am to 7 am (for 6 hours)

- 1  When 1:00 AM comes, Press "Timer energy saver" button.
  - Press the "Timer energy saver" button repeatedly until the "6" LED lights up.

The setting changes each time the button is pressed once

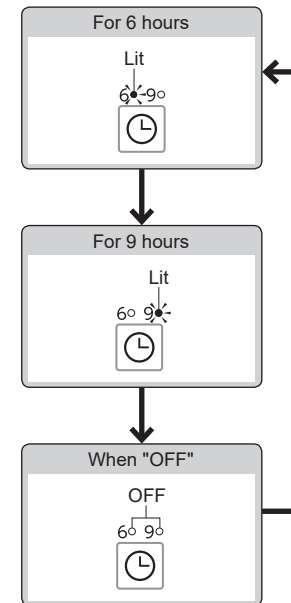

<Settings complete>

# Various Operations

## Setting List

Setting Types		Available Settings •Bold: Initial settings	
Auto functions	Cleaning Features	<b>Auto wand CLEAN</b>	ON / OFF
		<b>Pre-mist</b>	ON / OFF
		<b>Deodorizer</b>	ON / OFF
		<b>Auto power deodorizer</b>	ON / OFF
Other settings	<b>Beep sound</b>	ON / OFF	
	<b>Personal setting lock</b>	ON / OFF	

Settings	How to Set Ref. Page
• Set whether or not to <b>clean the wand automatically</b>	Page 28
• Set whether or not to <b>spray mist in the bowl unit automatically</b>	
• Set whether or not to <b>deodorize automatically after sitting on the toilet seat</b>	Page 29
• Set whether or not to <b>power deodorize automatically after standing up</b>	
• Set whether or not to <b>make a beep sound</b>	Page 30
• Set whether or not to <b>use the personal setting lock</b>	

### Check first!

### Buttons used for setting

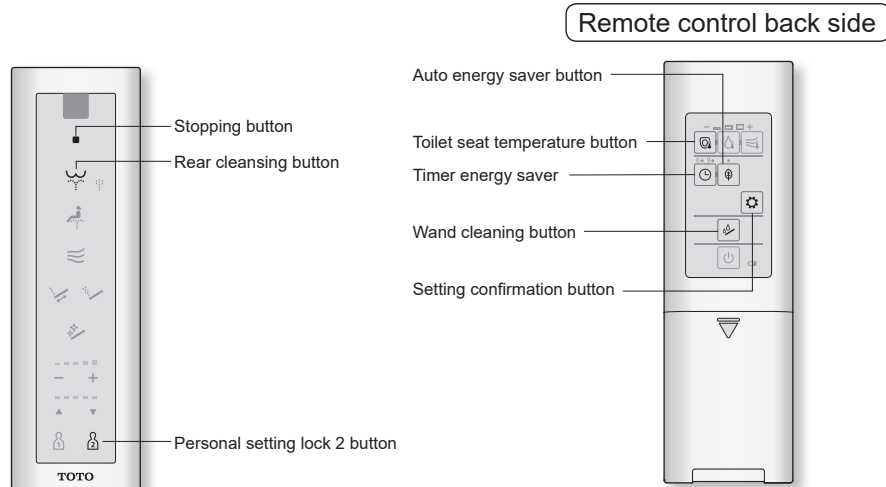

### LED indication during setting

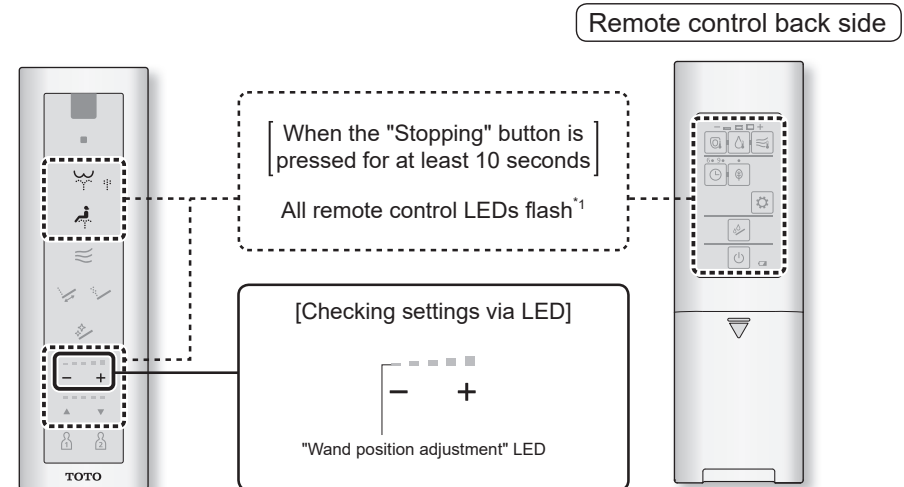

\*1 During setting, if the next button is not pressed within about 60 seconds, the light will stop flashing. If you fail to complete the setting, redo from the step 1.

# Various Operations

## Auto functions

### Cleaning Features

Set whether or not to clean the wand automatically

#### Auto wand CLEAN\*<sup>1</sup>

Set whether or not to spray mist in the bowl unit automatically

#### Pre-mist

**1** ■ Press "Stopping" button until all LEDs on the remote control start flashing. (about 10 seconds)

**2**  and 

Press "Timer energy saver" button and "Setting confirmation" button at the same time.

**The setting changes each time the button is pressed once**

Set whether or not to clean the wand automatically

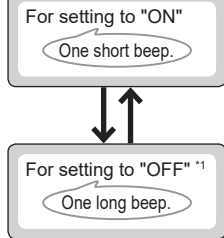

**2**  and 

Press "Auto energy saver" button and "Setting confirmation" button at the same time.

**The setting changes each time the button is pressed once**

Set whether or not to spray mist in the bowl unit automatically

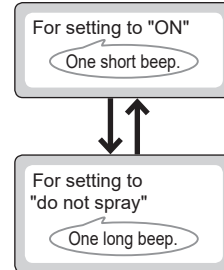

**3** ■ Press "Stopping" button.

<Settings complete>

### Cleaning Features

Set whether or not to deodorize automatically after sitting on the toilet seat

#### Deodorizer

Set whether or not to power deodorize automatically after standing up

#### Auto power deodorizer

**1** ■ Press "Stopping" button until all LEDs on the remote control start flashing. (about 10 seconds)

**2** 

Press "Wand cleaning" button about 5 seconds or longer.

**The setting changes each time the button is held down longer than 5 seconds.**

Set whether or not to deodorize automatically after sitting on the toilet seat

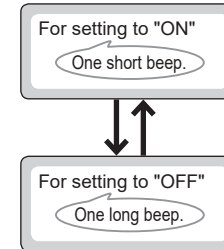

**2** 

Press "Toilet seat temperature" button.

**The setting changes each time the button is pressed once**

Set whether or not to power deodorize automatically after standing up

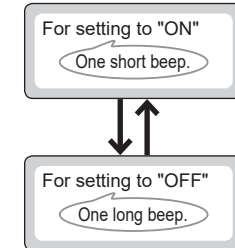

**3** ■ Press "Stopping" button.

<Settings complete>

\*1 When "Auto wand clean" is set to "OFF", the "Wand CLEAN" LED turns off.

# Various Operations

## Other settings

### Other settings

Set whether or not to make a beep sound

#### Beep sound<sup>\*1</sup>

Set whether or not to use the personal setting lock

#### Personal setting lock

- 1 Press "Stopping" button until all LEDs on the remote control start flashing. (about 10 seconds)

- 2 

Press "Rear cleansing" button.

The setting changes each time the button is pressed once

Set whether or not to make a beep sound

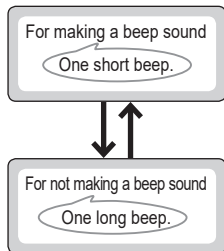

- 2 

Press "Personal setting lock 2" button for 5 seconds or longer.

The setting changes each time the button is held down longer than 5 seconds.

Set whether or not to use the personal setting lock  
• Check by "Wand position adjustment" LED (Page 27)

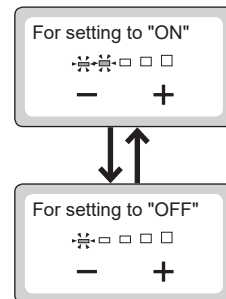

- 3 Press "Stopping" button.

<Settings complete>

<sup>\*1</sup> When you change each of the settings, set the electronic sound to "Make a beep sound".

# Maintenance

## Power Plug

### Power Plug (Approximately once a month)



Dry cloth



Wet cloth

- 1 Unplug the power plug and wipe it with a dry cloth.



- 2 Insert the power plug.  
• The "Power" LED lights up.

### WARNING

- Periodically remove dust from the blades and other parts of the power plug.  
• Unplug the power plug and wipe it with a dry cloth.
- Fully insert the power plug.
- When unplug the power plug, hold the main body of the power plug.  
• Pulling the power cord may damage the power plug or power cord.



### WARNING

- Always unplug the power plug from the outlet before maintenance or inspection.  
(Failure to do so may cause electric shock or malfunction, resulting in a breakdown.)

For safety, unplug the power plug before maintenance.<sup>\*1</sup>

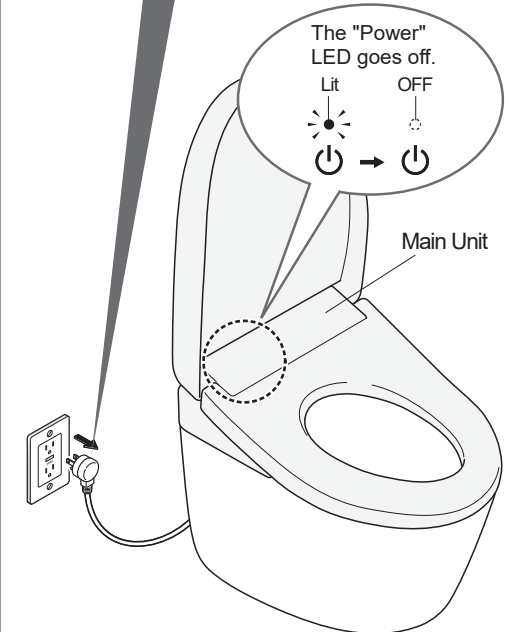

Do not use a dry cloth or toilet paper on plastic parts.  
(May cause damage.)



<sup>\*1</sup> Except when using "Wand cleaning".



### Main Unit (Approximately daily)

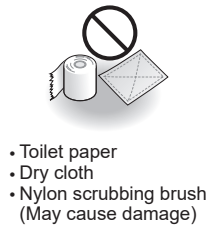

**1** Unplug the power plug.

**2** Wipe with a soft cloth that has been soaked in water and wrung out thoroughly.

**■ For heavy dirt**

- Wipe with a soft cloth soaked in diluted, neutral kitchen detergent, and then wipe with a soft cloth soaked in water.



**3** Insert the power plug.

- The "Power" LED lights up.

**Attention!**

- This product is an electric appliance. Be careful not to let water seep inside or leave detergent in the gap between the main unit and bowl unit. (May damage plastic parts or cause a malfunction.)
- When using a toilet cleaner to clean the toilet, rinse it off within 3 minutes and leave the toilet seat and toilet lid open.
  - Wipe off any cleaner that remains on the bowl unit. (If vapor from a toilet cleaner enters the main unit, it may cause a malfunction.)
- Do not push or pull the covers around the wand with undue force. (May cause damage or malfunction.)
- Wipe the back surface of the toilet seat and the toilet seat cushions with a soft cloth tightly wrung out with water. (Otherwise adhesion of dirt may result in discoloration.)

## Gap between the Main Unit and the Toilet Lid

### Gap between the Main Unit and the Toilet Lid (Approximately once a month)

The toilet lid can be removed for thorough cleaning.

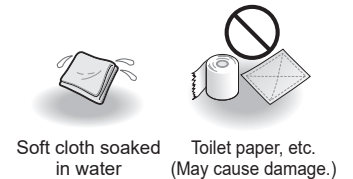

**1** Unplug the power plug.

**2** Remove the toilet lid.  
Slightly tilt the toilet lid to the front.

(A) : Pull the left side outward.

(B) : Disconnect the hinge from the recess and pull up.

(C) : Disconnect the right side.

**3** Wipe with a soft cloth that has been soaked in water and wrung out thoroughly.

**4** Reinstall the toilet lid.

(D) : Join the pin and the hinge on the right side.

Slightly tilt the toilet lid to the front.

(A) : While pulling out the left side,

(E) : Mount by joining the hinge with the recess.

\* Be careful not to pinch your fingers.

**5** Insert the power plug.

- The "Power" LED lights up.

**6** Open and close the toilet lid to check the reinstallation.

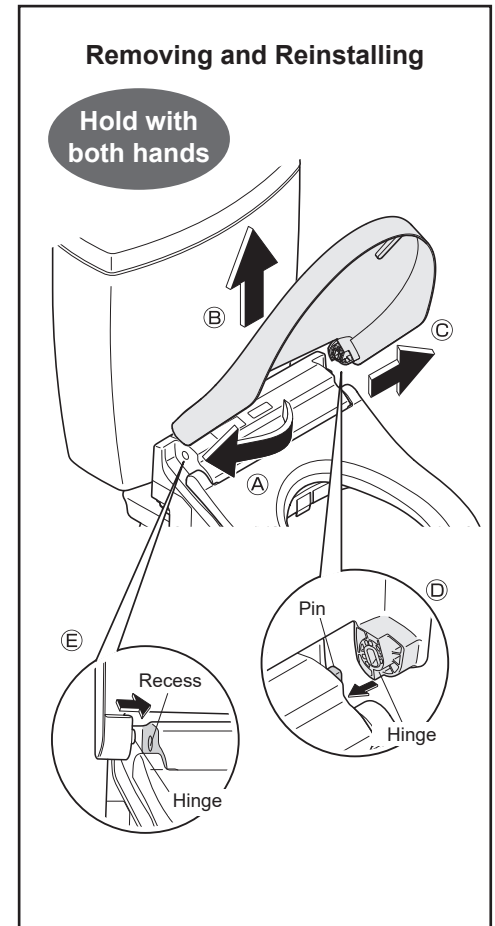

[SW3084T40]

### Gap between the Main Unit and Bowl Unit (Approximately once a month)

You can remove the main unit to clean the top of the bowl unit and the bottom of the main unit.



Soft cloth soaked in water Toilet paper, etc. (May cause damage.)



If the power is not unplugged, the product may malfunction or cause a failure or electric shock.

**1** Unplug the power plug.

**2** Remove the main unit.

- Do not pull the unit with undue force. (because the water supply hose and power cord are attached.)

(1) Pull the main unit toward you while pressing (2) Lift up the main unit.

Water supply hose Top of the bowl unit Base plate  
Power cord Bolt

Do not excessively bend the water supply hose.

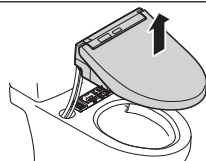

**3** Clean the top of the bowl unit and the bottom of the main unit.

- Wipe with a soft cloth soaked in a diluted, neutral kitchen detergent. Then, wipe it with a soft cloth soaked in water so that no detergent remains.

**4** Mount the main unit.

(1) Lift the main unit, then lower it straight down while threading the power cord and water supply hose into the recess on the bowl unit.

- Be careful not to pinch the power cord.
- Do not excessively bend the water supply hose

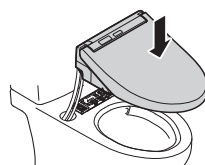

(2) Align the main unit with the center of the base plate and press it firmly onto the base plate until a click sound is heard.

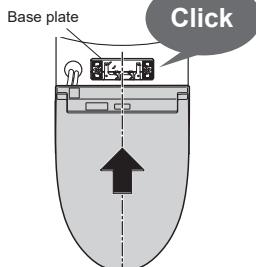

#### CAUTION

**!** Push the main unit firmly on to the base plate until a click sound is heard. (Doing so may cause the main unit to come loose and fall, resulting in injury.)

After mounting, check that the main unit does not detach even when pulled.

**5** Insert the power plug.

- The "Power" LED lights up.

[SW3084]

### Gap between the Main Unit and Bowl Unit (Approximately once a month)

You can remove the main unit to clean the top of the bowl unit and the bottom of the main unit.



Soft cloth soaked in water Toilet paper, etc. (May cause damage.)



If the power is not unplugged, the product may malfunction or cause a failure or electric shock.

**1** Unplug the power plug.

**2** Remove the main unit.

- Do not pull the unit with undue force. (because the water supply hose and power cord are attached.)

Water supply hose Top of the bowl unit  
Power cord Base plate

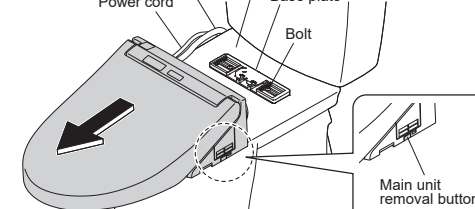

Pull the main unit toward you while pressing the "Main unit removal button".

**3** Clean the top of the bowl unit and the bottom of the main unit.

- Wipe with a soft cloth soaked in a diluted, neutral kitchen detergent. Then, wipe it with a soft cloth soaked in water so that no detergent remains.

**4** Mount the main unit.

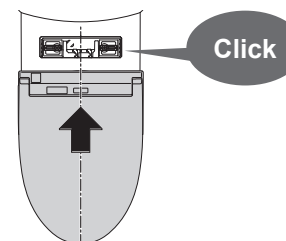

Align the main unit with the center of the base plate and press it firmly onto the base plate until a click sound is heard.

#### CAUTION

**!** Push the main unit firmly on to the base plate until a click sound is heard. (Doing so may cause the main unit to come loose and fall, resulting in injury.)

After mounting, check that the main unit does not detach even when pulled.

**5** Insert the power plug.

- The "Power" LED lights up.

### Deodorizing Filter (Approximately once a month)

- 1** Unplug the power plug.
- 2** Remove the deodorizing filter.
  - Hold the knob and pull outward.
  - Do not pull with undue force. (May cause damage or malfunction.)
- 3** Clean with a tool such as a toothbrush.
  - When washing with water, dry off all water before mounting.
- 4** Mount the deodorizing filter.
- 5** Insert the power plug.
  - The "Power" LED lights up.

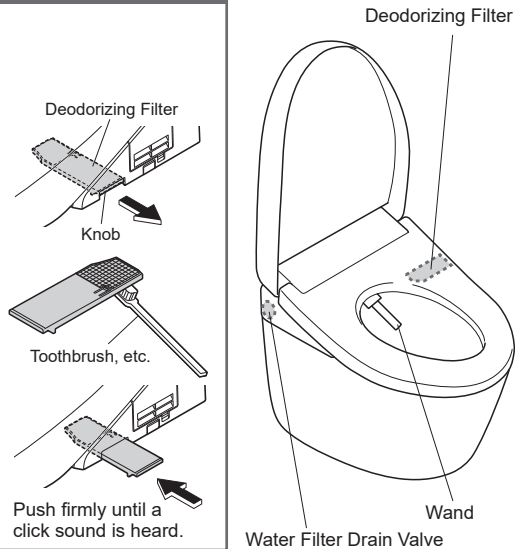

### Wand (Approximately once a month) <If you notice dirt (Wand cleaning)>

- 1** Extend the wand.
  - To operate from the back of remote control**
  - Press "Wand cleaning" button.
  - To operate from the front of remote control**
  - Recommended if the remote control is secured to prevent theft.
  - (1) ■ Press "Stopping" button until all LEDs on the remote control start flashing. (about 10 seconds)
  - (2) ■ Press "Front cleansing" button about 3 seconds or longer.
  - The wand extends and water flows out for cleaning.
  - The wand automatically retracts after about 5 minutes.

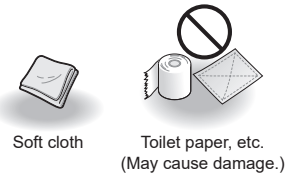

- 2** Wipe with a soft, wet cloth.
  - Do not pull, push or press the wand with excessive force. (May cause damage or malfunction.)
- 3** ■ Press "Stopping" button on the front side of the remote control.
  - The wand retracts.

### Water Filter Drain Valve (Approximately once every 6 months) <If you think the water pressure has weakened>

- 1** Close the shutoff valve.
  - The water supply stops.

#### CAUTION

- !** Do not remove the water filter drain valve while the shutoff valve is open. (Otherwise, water may leak out)

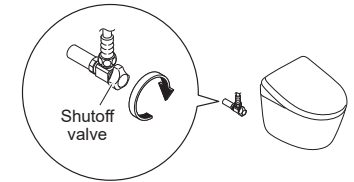

- 2** Extend the wand. (Release the pressure from the water supply pipe.)
  - To operate from the back of remote control**

- (1) ■ Press "Wand cleaning" button.
- (2) ■ Press "Stopping" button on the front side of the remote control.
  - The wand retracts.

#### To operate from the front of remote control

- Recommended if the remote control is secured to prevent theft.
- (1) ■ Press "Stopping" button until all LEDs on the remote control start flashing. (about 10 seconds)
- (2) ■ Press "Front cleansing" button about 3 seconds or longer.
- (3) ■ Press "Stopping" button on the front side of the remote control.
  - The wand retracts.

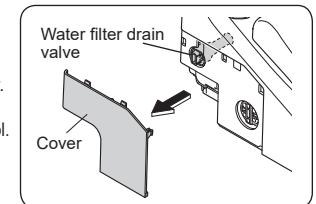

- 3** Unplug the power plug.
- 4** Remove the cover and water filter drain valve.
  - Loosen the water filter drain valve with a flat-head screwdriver and then pull it.
- 5** Clean with a tool such as a toothbrush.
  - Also, remove any dust from inside the hole of the water filter drain valve.
- 6** Reinstall the water filter drain valve and cover.
  - Insert the water filter drain valve and use a flat-head screwdriver to tighten it securely.
- 7** Insert the power plug.
  - The "Power" LED lights up.
- 8** Open the shutoff valve. (Page 15)

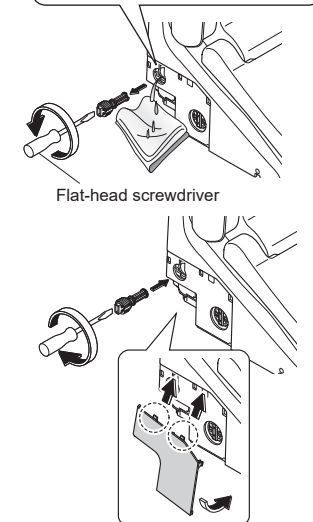

# What to Do?

## If the water does not flow due to a water service interruption

## If you cannot operate with the remote control

### If the water does not flow due to a water service interruption

- 1 Use a bucket to flush water.
- 2 If the water level is low after flushing, add more water.
  - Prevents odors.

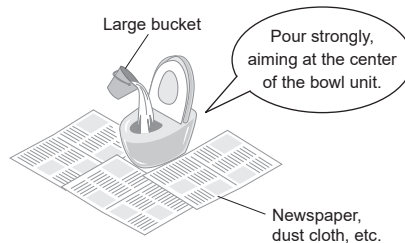

#### Attention!

- When the water supply is restored, be sure to perform a flush. (To prevent waste from remaining in the drain pipe.)

### If you cannot operate with the remote control

- If the low battery warning mark "  " on the back of the remote control is flashing, please replace the batteries.

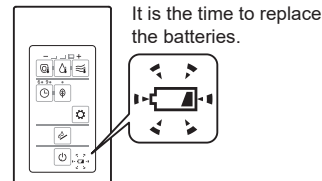

#### ■ Replacing the batteries

- 1 Unplug the power plug.
- 2 Remove the remote control from the hanger. (Page 14)
- 3 Open the battery cover and replace two AA batteries. (Page 14)
  - The low battery warning mark goes off.
- 4 Mount the remote control in the hanger.
- 5 Insert the power plug.
  - The "Power" LED lights up.

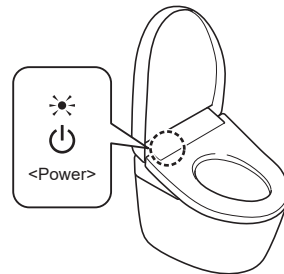

#### Attention!

- "ON" and "OFF" settings of the functions such as the energy saver function may be canceled when the batteries are replaced. Set them again.

## Freeze Damage Prevention

When the ambient temperature is likely to drop to 32 °F (0 °C) or lower, take measures to prevent freezing.

#### Attention!

- When the ambient temperature is likely to drop to 32 °F (0 °C) or lower, do not use the energy saver feature. (May damage the product.)
- Warm the bathroom or take measures against freezing so that the ambient temperature does not drop below 32 °F (0 °C).

### How to freeze damage prevention

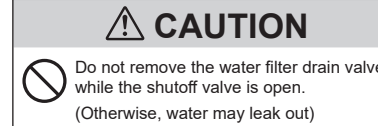

- 1 Close the shutoff valve. (Page 36)
  - The water supply stops.





- 2 Drain the water from the toilet tank.
  - Manipulate the lever/button/etc. until the water stops.

- 3 Extend the wand. (Release the pressure from the water supply pipe.)

#### To operate from the back of remote control

- (1)  Press "Wand cleaning" button.
- (2)  Press "Stopping" button on the front side of the remote control.
  - The wand retracts.

#### To operate from the front of remote control

- Recommended if the remote control is secured to prevent theft.
- (1)  Press "Stopping" button until all LEDs on the remote control start flashing. (about 10 seconds)
  - (2)  Press "Front cleansing" button about 3 seconds or longer.
  - (3)  Press "Stopping" button on the front side of the remote control.
    - The wand retracts.

- 4 Unplug the power plug.

- 5 Drain the pipe.
  - (1) Remove the cover and water filter drain valve.
    - Loosen the water filter drain valve with a flat-head screwdriver and then pull it.

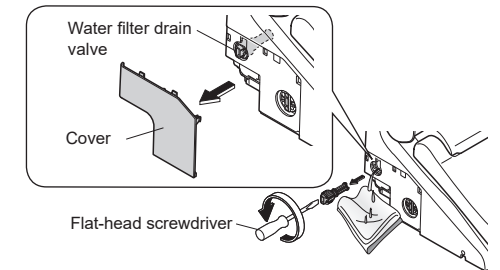

- (2) [Applicable to SW3084 only]
  - Drain the water from the water supply hose.

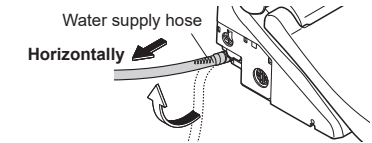

- (3) When water draining is completed, reinstall the water filter drain valve and cover.
  - Insert the water filter drain valve and use a flat-head screwdriver to tighten it securely.

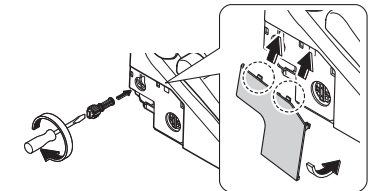

- 6 Insert the power plug.
  - The "Power" LED lights up.
- 7 Set the water and toilet seat temperature to "High". (Page 20)
  - To maintain the temperature, close the toilet seat and toilet lid after finishing work.

- To use the product again
  - The water needs to be resupplied. (Page 40)

# What to Do?

## Long Periods of Disuse

If the toilet is in a location you will not visit for a long time, drain the water.  
(Failure to do so may cause breakdown or skin irritation due to polluted product tank water.)

### How to drain the water

- 1** Drain the water from the toilet tank.  
(Page 39 Step **1** **2**)
- 2** Extend the wand.  
(Release the pressure from the water supply pipe.)  
(Page 39 Step **3**)
- 3** Unplug the power plug.
- 4** Drain the pipe. (Page 39 Step **5**)  
\*After draining the water, Keep the cover removed.
- 5** Loosen the water drain plug until water comes out from around the wand.  
• Water comes out from around the wand.  
(It takes about 3 minutes to complete draining.)  
\* The water drain plug cannot be removed.
- 6** Tighten the water drain plug securely with a flat-head screwdriver and reinstall the cover.

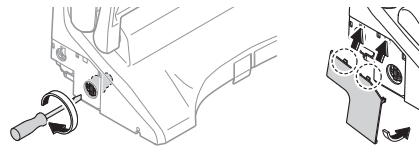
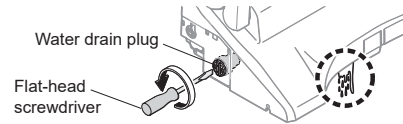

- If water may get frozen
  - Add antifreeze solution in the water in the bowl to prevent freezing.  
(The antifreeze solution should not be flushed out. Collect it before using the toilet and dispose of it.)
- To use the product again
  - The water needs to be resupplied. (See below)

### Resupplying the Water

- 1** Open the shutoff valve.
  - Check that water is not leaking from a pipe or the main unit.
- 2** Insert the power plug.
  - The "Power" LED lights up.
- 3** Discharge water from the wand.
  - (1) Pressing down the left side of the toilet seat,
  - (2) Press "Rear cleansing" button on the remote control to discharge water from the wand for about 2 minutes.
    - It takes about 1 minute maximum before water comes out.
    - Catch the water in a paper cup or other receptacle.
  - (3) Press the "Stopping" button on the remote control.

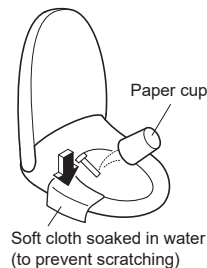

- If the remaining water has frozen and no water comes out
  - Heat the inside of the bathroom, and warm the water supply hose and shutoff valve using a cloth soaked in warm water.

## Removal of Operation Guide

Follow the procedure below.

### How to remove the operation guide

- 1** Unplug the power plug.
- 2** Remove the remote control from the hanger.  
(Page 14)
- 3** Remove the hanger and operation guide.

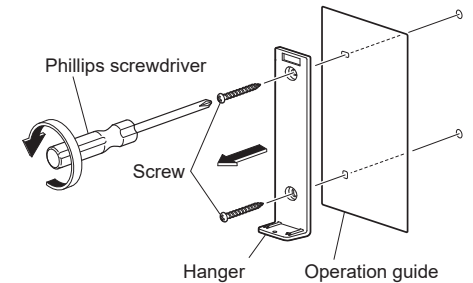

- 4** Screw the hanger on the wall.

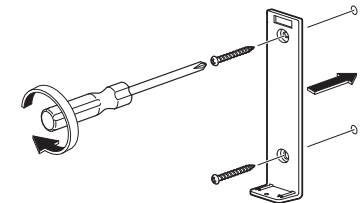

- 5** Mount the remote control in the hanger.
- 6** Insert the power plug.
  - The "Power" LED lights up.

- To install back the operation guide, follow the procedure above.  
(Install the operation guide at step **4**.)

# Troubleshooting

First, try the actions described on pages 42 - 45.  
If the problem persists, consult the installer, seller, or TOTO customer service.  
(see contact information on the back cover.)

**CAUTION**

**!** If a water leak occurs, close the shutoff valve.

Shutoff valve

## Please check first

### Is the Power LED lit?

- **Is the breaker on the distribution board turned on?**  
→ Check whether there is a power outage or the breaker has turned "OFF".
- **Is the "Power ON/OFF" setting "OFF"?**  
→ Switch it to "ON" with the remote control. (Page 15 Step2-2)
- **Is the "Power" LED on the main display flashing?**  
→ The main unit is not mounted properly. Mount them correctly again. (Pages 34, 35)

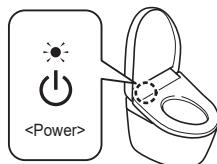

### Is the Energy saver LED lit?

- **While the LED is lit, energy saver (Pages 22, 23) is in operation, so the toilet seat temperature may be reduced or the warm water heater and toilet seat heater may be turned off.**

### Is the remote control working?

- **Is the " " LED on the back of the remote controller flashing?**  
→ Replace the batteries. (Pages 14, 41)
- **Is the remote control transmitter or the remote control receiver blocked?**  
→ Remove obstructions, dirt, water droplets or any other blockages.

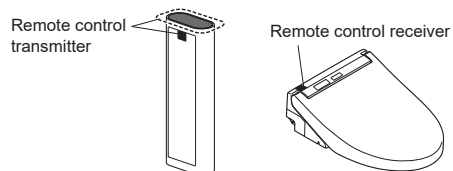

The remote control uses batteries to operate.

## Rear cleansing, Rear soft cleansing, Front cleansing and Wand

Trouble	Please check	Ref. Page
<b>The wand (or cleansing water) does not come out</b>	● Did you sit on the toilet continuously for 2 hours or longer? (If so, operation is stopped for safety purposes.) → Stand up from the seat and then use again.	-
	● The seat switch will not turn on unless you sit on the seat properly. → Sit back on the toilet seat.	11
	● Are you using a toilet seat cover, a toilet lid cover or a seat for infants? → Remove any covers. When using a seat for infants or a soft highchair, remove after each use.	11
	● Are you pressing "Wand CLEAN" button? • When you press "Wand CLEAN" button, "EWATER+" comes out from the vicinity of the wand to clean the wand. → To clean the wand with it extended, perform "Wand cleaning".	36
<b>The wand extends but the cleansing water does not come out / The cleansing water pressure is weak</b>	● Has a water failure occurred? → Press "Stopping" button on the remote control and wait until water service is restored.	-
	● Is the shutoff valve closed? → Fully open the shutoff valve.	15
	● Is the water filter drain valve clogged with foreign matter? → Clean the filter.	37
	● Is the water pressure set to a low level?	18
<b>The cleansing water is cold</b>	● Is the water drain plug loosened? → Tighten the water drain plug securely.	40
	● Is the warm water temperature set to "OFF" or a low level? ● When the temperature of the water supply or the bathroom is low, the water temperature may be low when first sprayed.	20
	● Is the timer energy saver in operation? • The energy saver feature is on when the "Energy saver" LED is on and the "Power" LED is off on the main display. When you sit on the seat, the warm water heater is temporarily turned on and water is warmed in about 10 minutes. → When the timer energy saver is set to "ON", you can also turn it "OFF".	22, 23
		25
<b>Stops in the middle of use</b>	● "Rear cleansing", "Rear soft cleansing" and "Front cleansing" stop automatically after 5 minutes of continuous use. ● Does the seat switch have difficulty detecting? → Sit back on the toilet seat. If you get up slightly from the seat, or sit forward on the seat, the seating switch may temporarily stop detecting your presence.	- 11
<b>Water comes out unexpectedly from the wand</b>	● Water may sometimes come out from around the wand when it expands in the warm water tank. ● Is the "Wand CLEAN" LED on the main display flashing? → "Auto Wand CLEAN" starts and the wand is cleaned.	- 16

# Troubleshooting

## Warm air drying

Trouble	Please check	Ref. Page
The dryer temperature is low	<ul style="list-style-type: none"> <li>Is the dryer temperature set to low level?</li> </ul>	20
Stops in the middle of use	<ul style="list-style-type: none"> <li>The feature stops automatically after about 10 minutes of continuous use.</li> <li>Does the seat switch have difficulty detecting?                             <ul style="list-style-type: none"> <li>→ Sit back on the toilet seat. If you get up slightly from the seat, or sit forward on the seat, the seating switch may temporarily stop detecting your presence.</li> </ul> </li> </ul>	11

## Toilet Seat and Toilet Lid

Trouble	Please check	Ref. Page
The toilet seat is cold	<ul style="list-style-type: none"> <li>Is the toilet seat temperature set to "OFF" or a low level?</li> </ul>	20
	<ul style="list-style-type: none"> <li>Is energy saver in operation?                             <ul style="list-style-type: none"> <li>The energy saver feature is on when the "Energy saver" LED is on and the "Power" LED is off on the main display. When you sit on the seat, the toilet seat heater is turned on temporarily and the seat is warmed in about 15 minutes.</li> <li>→ You can turn it "OFF" if the energy saver feature is "ON".</li> </ul> </li> </ul>	22, 23 24, 25
	<ul style="list-style-type: none"> <li>Have you been seated for a long time?                             <ul style="list-style-type: none"> <li>After about 20 minutes of sitting, the temperature starts going down, and after about 1 hour, the toilet seat heater is turned "OFF".</li> <li>→ Stand up from the seat and then use again.</li> </ul> </li> <li>Did you put anything on the toilet seat or the toilet lid?                             <ul style="list-style-type: none"> <li>→ Remove anything placed on top of the toilet seat or lid.</li> </ul> </li> </ul>	-
	<ul style="list-style-type: none"> <li>Is a toilet lid or seat cover installed?                             <ul style="list-style-type: none"> <li>→ Remove any covers.</li> </ul> </li> </ul>	11

## Energy Saver

Trouble	Please check	Ref. Page
The energy saver LED does not light up	<ul style="list-style-type: none"> <li>Did you unplug the power plug or was there a power outage?                             <ul style="list-style-type: none"> <li>The "Energy saver" LED on the main display may go off when the power is turned on even if the energy saver feature is "ON". (It will turn on within about 24 hours since the setting is retained.)</li> </ul> </li> </ul>	-
The timer energy saver feature is not working	<ul style="list-style-type: none"> <li>Did you replace the remote control batteries?                             <ul style="list-style-type: none"> <li>"Timer energy saver" may be canceled when the batteries are replaced.</li> <li>→ Set the timer energy saver again at the time you want to start it.</li> </ul> </li> </ul>	25
The auto energy saver feature is not working	<ul style="list-style-type: none"> <li>Because the function takes several days learning the usage conditions before starting energy saver, the amount of energy saving may be low, depending on the frequency of use.                             <ul style="list-style-type: none"> <li>→ Check the energy saver setting.</li> </ul> </li> </ul>	22, 23

## Deodorizer

Trouble	Please check	Ref. Page
The deodorizer seems to be not working	<ul style="list-style-type: none"> <li>Is "Deodorizer" set to "OFF"? → Set to "ON".</li> <li>Even after sitting down, you do not hear operation sounds.                             <ul style="list-style-type: none"> <li>→ Sit back on the toilet seat.</li> <li>If you hear an operation sound when you sit on the toilet seat.</li> <li>→ Clean the deodorizing filter.</li> </ul> </li> </ul>	29 -
A strange odor is emitted	<ul style="list-style-type: none"> <li>Are you using an air freshener or deodorizer that you purchased separately?                             <ul style="list-style-type: none"> <li>Doing so may reduce the effectiveness of the product's deodorizer or cause strange odors.</li> <li>→ Remove the air freshener or deodorizer.</li> </ul> </li> </ul>	-
The auto power deodorizer feature is not working	<ul style="list-style-type: none"> <li>Is "Auto power deodorizer" set to "OFF"? → Set to "ON".</li> <li>It starts about 10 seconds after you stand up from the toilet seat.</li> </ul>	29 -

## Sanitary

Trouble	Please check	Ref. Page
The Wand CLEAN LED does not light up	<ul style="list-style-type: none"> <li>If the "Wand CLEAN" LED does not light up, it is time to replace the component that generates "EWATER+". Consult the installer, seller, or TOTO customer service. (see contact information on the back cover.)</li> </ul>	-

## Others

Trouble	Please check	Ref. Page
Water is leaking from the plumbing connections	<ul style="list-style-type: none"> <li>If the nut of the connecting pipe is loosened, retighten it by hand. (Do not use any tool.)                             <ul style="list-style-type: none"> <li>→ If the water leak does not stop, close the shutoff valve and consult with TOTO customer service. (see contact information on the back cover.)</li> </ul> </li> </ul>	-
The main unit is unstable	<ul style="list-style-type: none"> <li>There is clearance between the toilet seat cushion and the bowl unit for activating the seat switch. When you sit on the toilet seat, the toilet seat subsides slightly to activate the seat switch.</li> <li>Are the bolts that anchor the main unit loose?                             <ul style="list-style-type: none"> <li>→ Remove the main unit and then firmly tighten the base plate bolts.</li> </ul> </li> </ul>	11 34, 35
The main unit makes a sound	When sitting on the toilet seat	
	<ul style="list-style-type: none"> <li>When "Pre-mist" is "ON", you hear operation sounds for preparing the pre-mist or spraying mist in the bowl unit.                             <ul style="list-style-type: none"> <li>→ You can turn it "OFF".</li> </ul> </li> </ul>	16 28
	When moving away from the bowl unit after use	
	<ul style="list-style-type: none"> <li>When "Auto power deodorizer" is "ON", operation sounds are made while the deodorizing power increases for 60 seconds after you stand up from the toilet seat.                             <ul style="list-style-type: none"> <li>→ You can turn it "OFF".</li> </ul> </li> <li>If "Auto wand CLEAN" is "ON" and you use the cleansing functions (e.g., Rear cleansing and Front cleansing), you may hear that the wand is extended and cleaned with "EWATER+".                             <ul style="list-style-type: none"> <li>→ You can turn it "OFF".</li> </ul> </li> </ul>	29 28
You feel air in the bowl unit when sitting on the toilet seat	When not using the product (e.g., at night)	
	<ul style="list-style-type: none"> <li>If "Auto wand CLEAN" is "ON" and you do not use the cleansing functions (e.g., Rear cleansing and Front cleansing) for about 8 hours, you will hear that the wand is cleaned with "EWATER+" and then the remaining water is drained from inside the product.                             <ul style="list-style-type: none"> <li>→ You can turn it "OFF".</li> </ul> </li> </ul>	28
	<ul style="list-style-type: none"> <li>A mist is sprayed inside the bowl unit to make it more difficult for dirt to adhere when sitting on the toilet seat. You may feel air when a mist is sprayed.                             <ul style="list-style-type: none"> <li>→ You can turn it "OFF".</li> </ul> </li> </ul>	- 28

# Specifications

Item		SW3084T40 SW3084	
Rated power supply		AC 120 V, 60 Hz	
Rated power consumption		403 W	
Maximum power consumption <sup>*1</sup>		512 W	
Type of water heater		Tank type	
Power cord length		3.93 ft (1.2 m)	
Water protection level		IPX4	
Cleansing	Spray volume	Rear cleansing	Approx. 0.07-0.11 gal / min (Approx. 0.27-0.43 L / min) <at 29 PSI (0.20 MPa) water pressure>
		Rear soft cleansing	Approx. 0.07-0.11 gal / min (Approx. 0.27-0.43 L / min) <at 29 PSI (0.20 MPa) water pressure>
		Front cleansing	Approx. 0.08-0.11 gal / min (Approx. 0.29-0.43 L / min) <at 29 PSI (0.20 MPa) water pressure>
	Water temperature		Adjustable temperature range : OFF, about 95-104 °F (about 35-40 °C)
	Toilet tank capacity		Approx. 0.13 gal (Approx. 0.49 L)
	Heater capacity		225 W
	Safety device		Temperature fuse, anti-idling float switch
	Backflow prevention device		Vacuum breaker, Check valve
Heated seat	Surface temperature		Adjustable temperature range : OFF, about 82-97 °F (about 28-36 °C) (Auto energy saver : about 79 °F (about 26 °C))
	Heater capacity		48 W
	Safety device		Temperature fuse
Deodorizer	Method		O <sub>2</sub> deodorization
	Airflow volume		Normal mode : Approx. 3.18 ft <sup>3</sup> / min (Approx. 0.09 m <sup>3</sup> / min) Power mode : Approx. 5.65 ft <sup>3</sup> / min (Approx. 0.16 m <sup>3</sup> / min)
	Power consumption		Normal mode : Approx. 1.7 W, Power mode : Approx. 5.3 W
Warm air dryer	Warm air temperature <sup>*2</sup>		Adjustable temperature range : about 95-140 °F (about 35-60 °C)
	Airflow volume		Approx. 8.83 ft <sup>3</sup> / min (Approx. 0.25 m <sup>3</sup> / min)
	Heater capacity		347 W
	Safety device		Temperature fuse
Water supply pressure		Minimum required water pressure : 7.25 PSI (0.05 MPa) <dynamic> Maximum water pressure : 108.78 PSI (0.75 MPa) <static>	
Water supply temperature		32-95 °F (0-35 °C)	
Working ambient temperature		32-104 °F (0-40 °C)	
Dimensions		W 1.26 ft × D 1.74 ft × H 0.48 ft W 383 mm × D 530 mm × H 147 mm	
Weight		About 11 lb (About 5 kg)	

\*1 Maximum power consumption for warm water or heated toilet seat.

\*2 Temperature around the warm air outlet measured by TOTO.

●When disposing of this product, please follow your local or state guidelines for proper disposal.

# Limited Warranty

## One Year Limited Warranty

- TOTO warrants its products to be free from defects in materials and workmanship during normal use when properly installed and serviced, for a period of one (1) year from date of purchase. This limited warranty is extended only to the ORIGINAL PURCHASER of the product and is not transferable to any third party, including but not limited to any subsequent purchaser or owner of the product. This warranty applies only to TOTO product is purchased and installed in USA and Canada.
- TOTO's obligations under this warranty are limited to repair, replacement or other appropriate adjustment, at TOTO's option, of the product or parts found to be defective in normal use, provided that such product was properly installed, used and serviced in accordance with instructions.  
TOTO reserves the right to make such inspections as may be necessary in order to determine the cause of the defect. TOTO will not charge for labor or parts in connection with warranty repairs or replacements. TOTO is not responsible for the cost of removal, return and/or reinstallation of the product.
- This Warranty does not apply to the following items:
  - Damage or loss sustained in a natural calamity such as fire, earthquake, flood, thunder, electrical storm, etc.
  - Damage or loss resulting from any accident, unreasonable use, misuse, abuse, negligence, improper care, or maintenance of the product.
  - Damage or loss resulting from sediments or foreign matter contained in a water system.
  - Damage or loss resulting from the quality of water in the region where the product is used.
  - Damage or loss resulting from improper installation or from installation of the product in a harsh and/or hazardous environment, or improper removal, repair or modification of the product. This includes locations where the water pressure is above local codes or standards. (NOTE : Product model codes allow a maximum of 80 PSI. Check local codes or standards for requirements).
  - Damage or loss resulting from electrical surges or lightning strikes or other acts which are not the fault of TOTO or which the product is not specified to tolerate, including failure to use the factory equipped cord and plug or use of a loose or faulty electrical outlet or use of a current or socket other than a 120V, 60Hz electrical current from a GFI (ground, fused) socket.
  - Damage or loss resulting from normal and customary wear and tear, such as gloss reduction, scratching or fading over time due to use, cleaning practices or water or atmospheric conditions, including but not limited to, the use of bleach, alkali, acid cleaners, dry (powder) cleaners or any other abrasive cleaners or the use of metal or nylon scrubbers.
- If the Danger Label which has been placed over the seams on the back of the product's top unit is broken or otherwise not intact, this limited warranty is void.
- In order for this limited warranty to be valid, proof of purchase is required. TOTO encourages warranty registration upon purchase to create a record of product ownership at <http://www.totousa.com>. Product registration is completely voluntary and failure to register will not diminish your limited warranty rights.
- If the product is used commercially or is installed outside of USA and Canada, TOTO warrants the product to be free from defects in materials and workmanship during normal use for one (1) year from the date of installation of the product, and all other terms of this warranty shall be applicable except the duration of the warranty.
- This warranty gives you specific legal rights. You may have other rights which vary from state to state, province to province or country to country.
- To obtain warranty repair service under this warranty, you must take the product or deliver it prepaid to a TOTO service facility together with proof of purchase (original sales receipt) and a letter stating the problem, or contact a TOTO distributor or products service contractor, or write directly to TOTO U.S.A., INC., 1155 Southern Road, Morrow, GA 30260 (888) 295-8134 or (678) 466-1300, if outside the U.S.A. If, because of the size of the product or nature of the defect, the product cannot be returned to TOTO, receipt by TOTO of written notice of the defect together with proof of purchase (original sales receipt) shall constitute delivery. In such case, TOTO may choose to repair the product at the purchaser's location or pay to transport the product to a service facility.  
**WARNING!** TOTO shall not be responsible or liable for any failure of, or damage to, this product caused by either chloramines in the treatment of public water supply or cleaners containing chlorine (calcium hypochlorite).  
NOTE: The use of a high concentrate chlorine or chlorine related products can seriously damage the fittings. This damage can cause leakage and serious property damage.

THIS WRITTEN WARRANTY IS THE ONLY WARRANTY MADE BY TOTO. REPAIR, REPLACEMENT OR OTHER APPROPRIATE ADJUSTMENT AS PROVIDED UNDER THIS WARRANTY SHALL BE THE EXCLUSIVE REMEDY AVAILABLE TO THE ORIGINAL PURCHASER. TOTO SHALL NOT BE RESPONSIBLE FOR LOSS OF THE PRODUCT OR FOR OTHER INCIDENTAL, SPECIAL OR CONSEQUENTIAL DAMAGES OR EXPENSES INCURRED BY THE ORIGINAL PURCHASER, OR FOR LABOR OR OTHER COSTS DUE TO INSTALLATION OR REMOVAL, OR COSTS OF REPAIRS BY OTHERS, OR FOR ANY OTHER EXPENSE NOT SPECIFICALLY STATED ABOVE. IN NO EVENT WILL TOTO'S RESPONSIBILITY EXCEED THE PURCHASE PRICE OF THE PRODUCT. EXCEPT TO THE EXTENT PROHIBITED BY APPLICABLE LAW, ANY IMPLIED WARRANTIES, INCLUDING THAT OF MERCHANTABILITY OR FITNESS FOR USE OR FOR A PARTICULAR PURPOSE, ARE EXPRESSLY DISCLAIMED. SOME STATES DO NOT ALLOW LIMITATIONS ON HOW LONG AN IMPLIED WARRANTY LASTS, OR THE EXCLUSION OR LIMITATION OF INCIDENTAL OR CONSEQUENTIAL DAMAGES, SO THE ABOVE LIMITATION AND EXCLUSION MAY NOT APPLY TO YOU.