

Features

- 3D LED Color Temperature Lights with Dimmable touch control
- Mirrored interior with 4 adjustable glass shelves
- Includes Digital Clock
- Includes Defogger with push button
- Includes one USB outlet
- Includes installation hardware for recess mounting
- Can be recessed or surface mounted
(surface mounting is included)
- Interior Light with sensor switch
- Energy efficient LED lighting:
Integrated LED 3X Magnifying Mirror

Kelvin	3000	6500	4500 mixed color
CRI	80+	80+	80+
Lumens*†	810	810	1620
R9 Value*	50+	50+	50+
Watts (AC)	60	60	60
Lumens per Watt	90	90	90

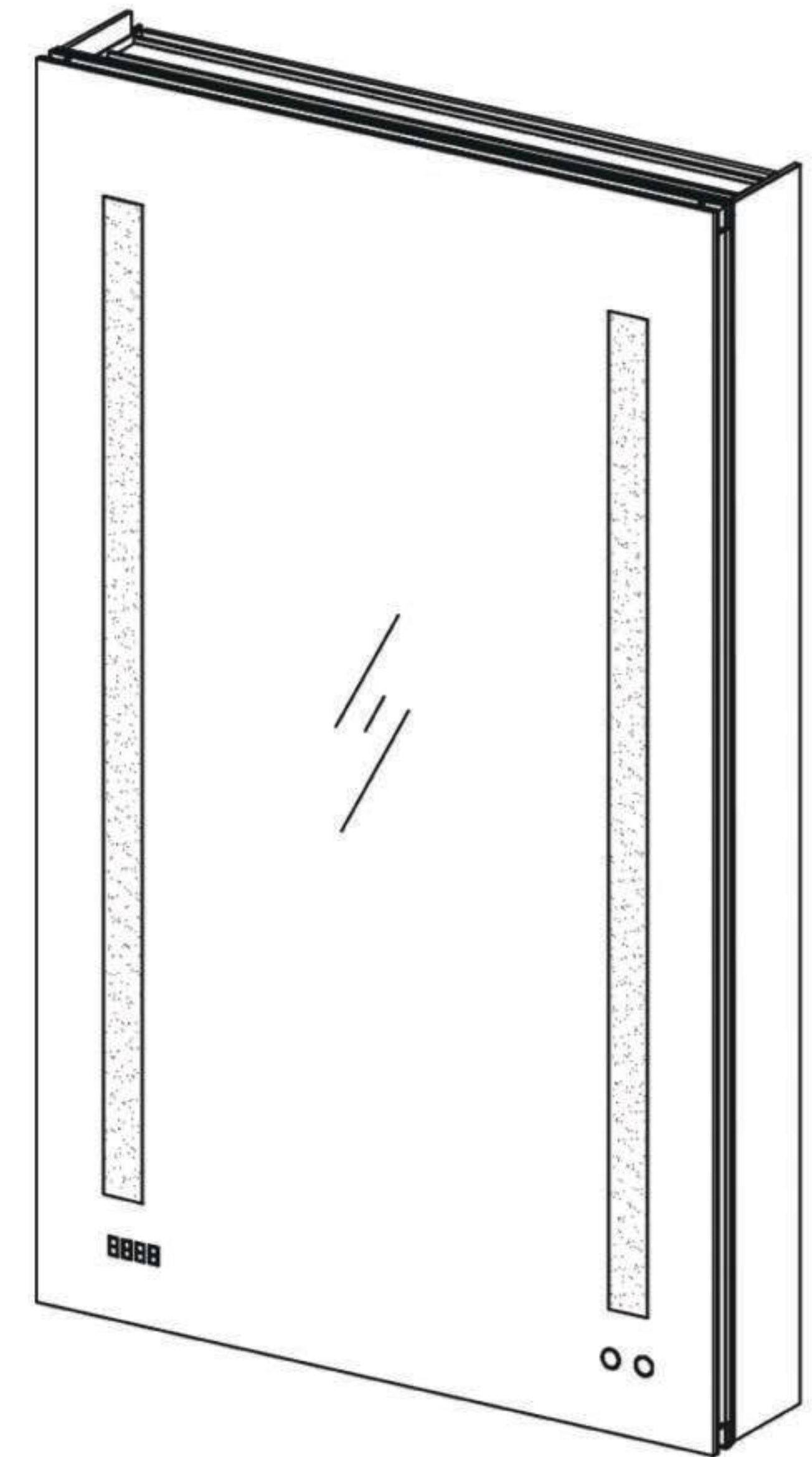

Construction

- Grey aluminum body and door frame
- 3 mirror design – rear of cabinet and both sides of door
- Concealed finger pull-door edge
- 3 DTC 155° self-closing hinges on left hand
- Adjustable shelving at 3-1/7" (80 mm) increments
- Single field wire into electrical shelf - Front access serviceability

Codes/Standards Applicable

Electric Option Models are ETL certified to:

- UL 962
- CSA Standard C22.2 No. 68

Dimensions

Height: 40" (1016 mm)

Width: 24" (610 mm)

Depth: 5" (127 mm) When surface mounted

1" (25 mm) When recessed



Installation Options

- Recessed Mount - Rough Opening - 39-1/2" H x 23-1/2" W x 4" D (1003.3mm H x 597mm W x 102mm D)
- Surface Mount - Surface Mount Kit is included

Electrical System

- 60 Watts LED Driver
- INPUT : 120VAC 60HZ 1.2A
- OUTPUT : 12VAC 5.0A
- Field wire location as shown in drawing
- 1/2" conduit (Ø 7/8" actual) electrical knockout location shown below
- Included field wire cable clamp
- Circuit Diagram

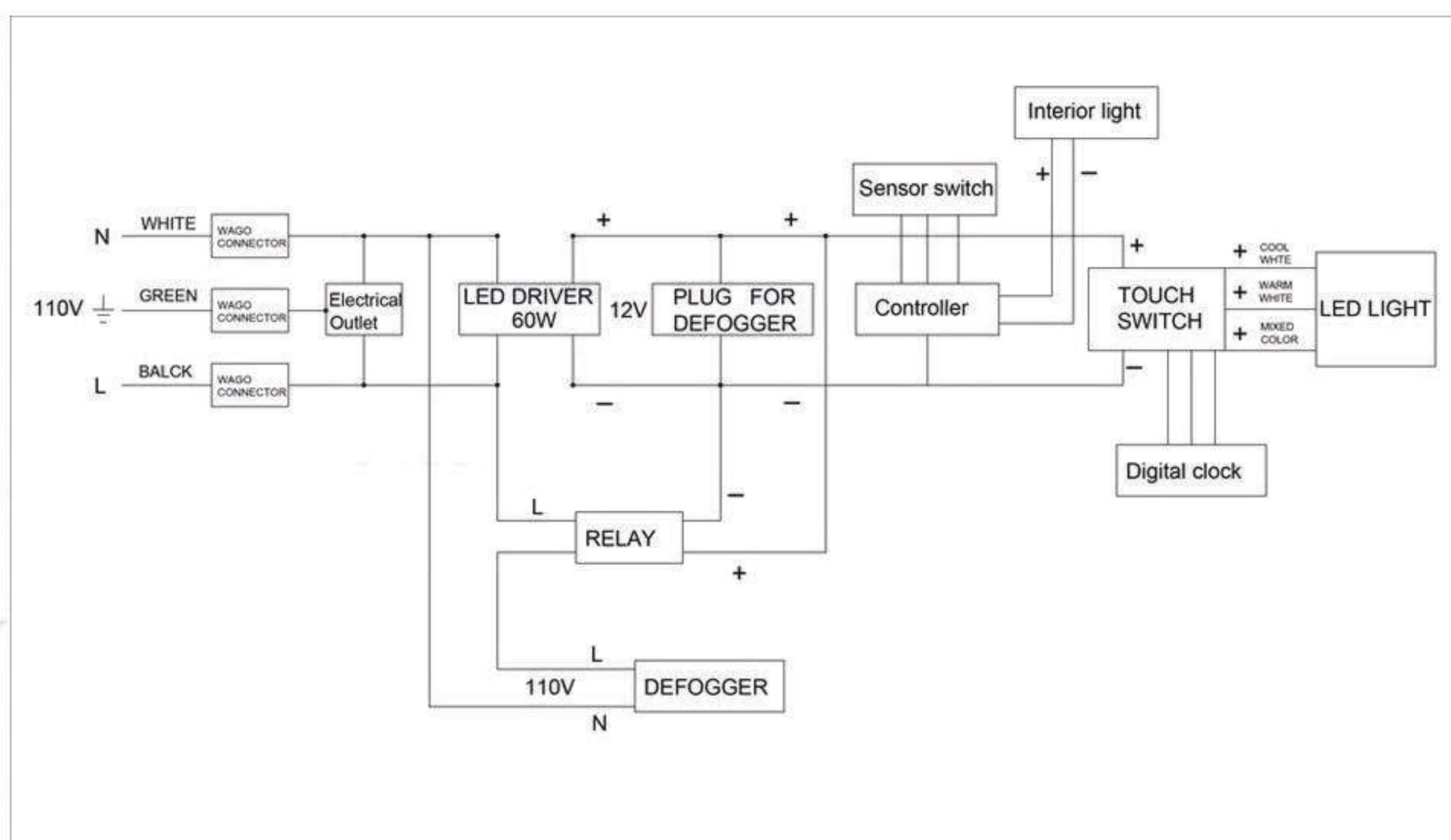

Circuit Diagram

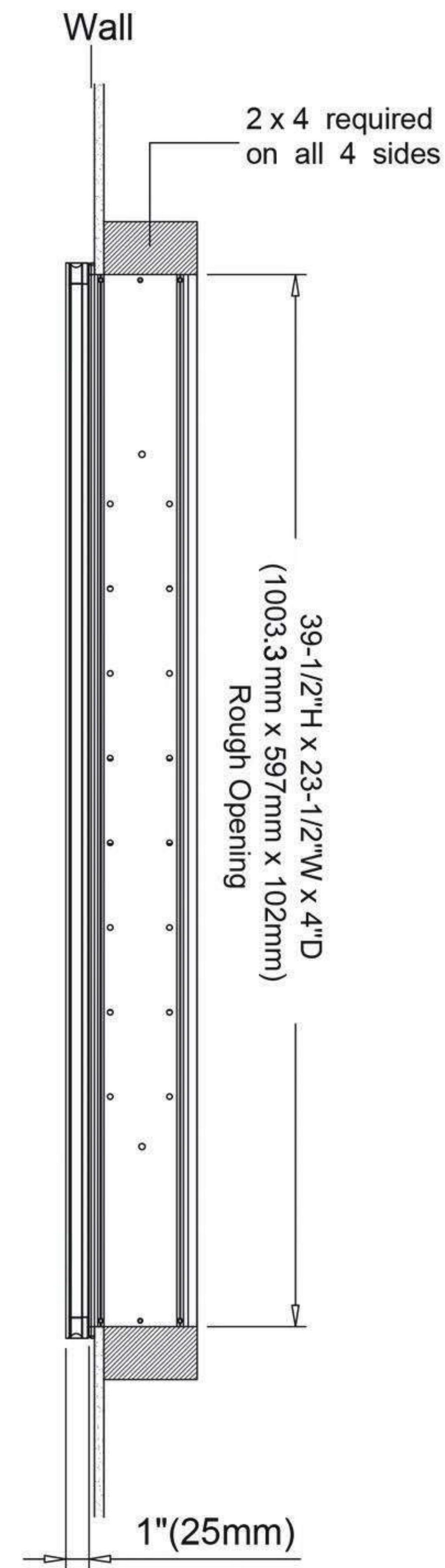

Recessed Mount

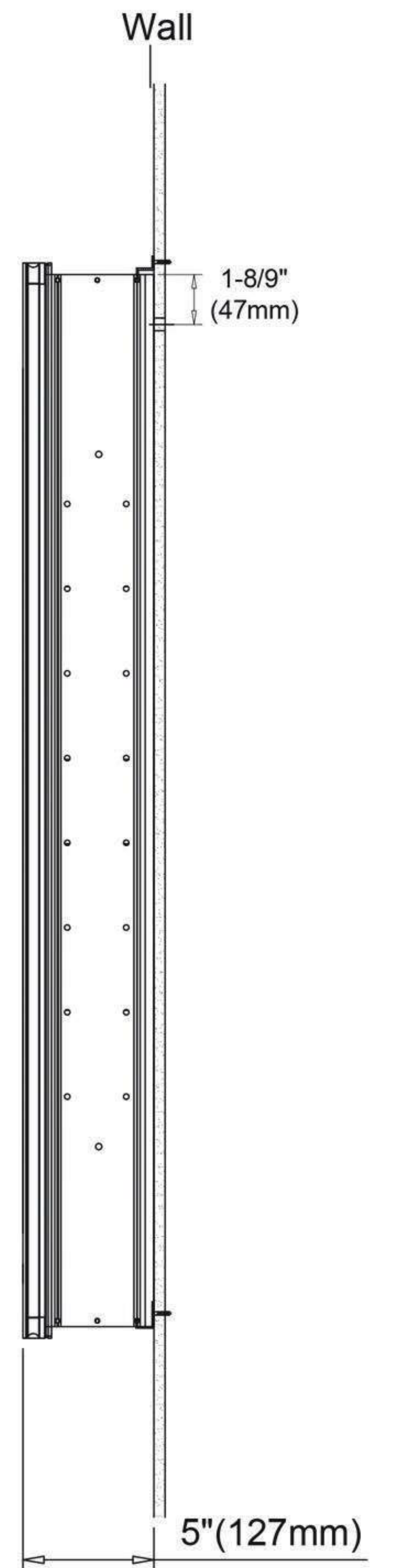

Surface Mount

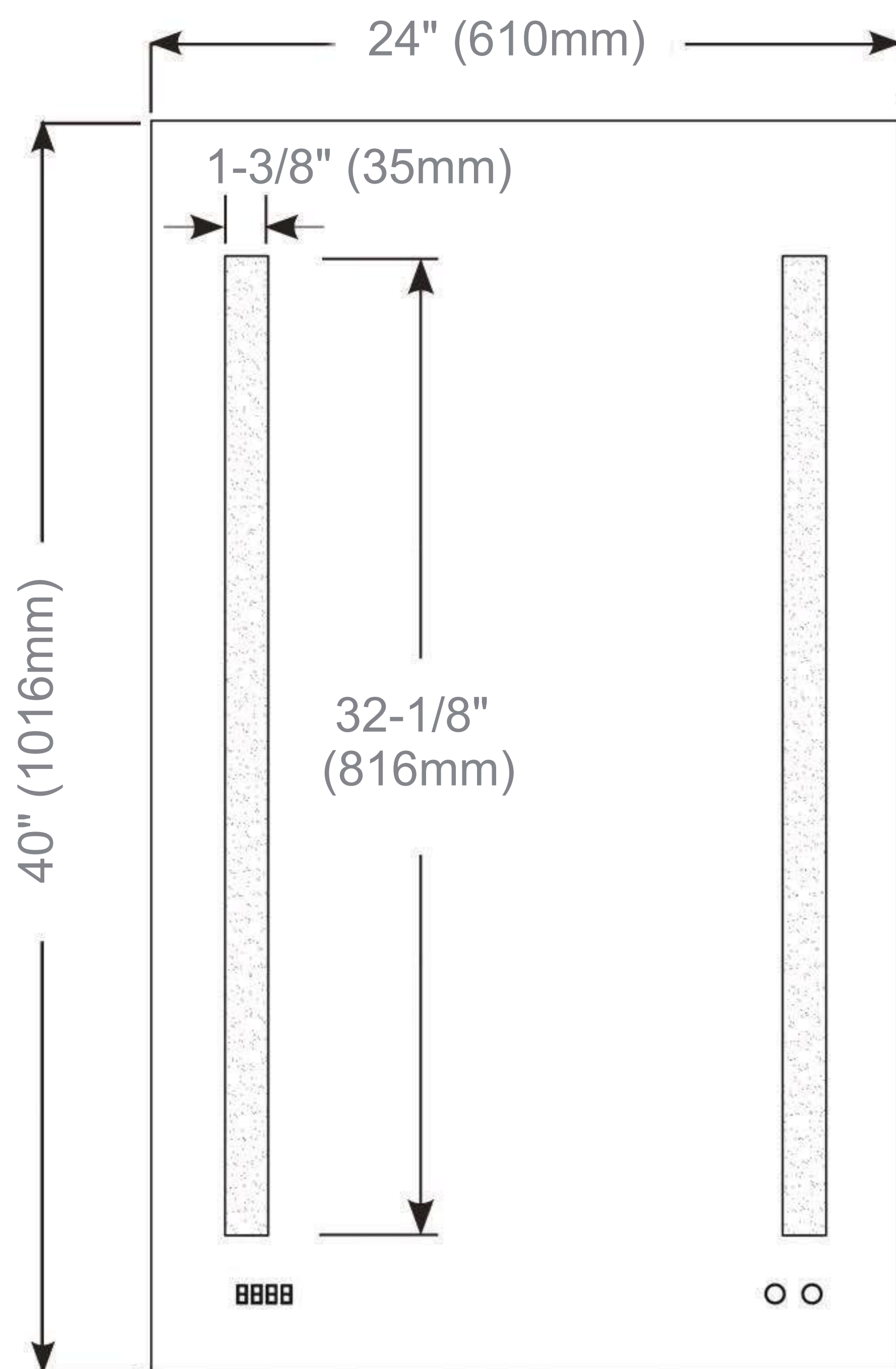

Cabinet Dimensions

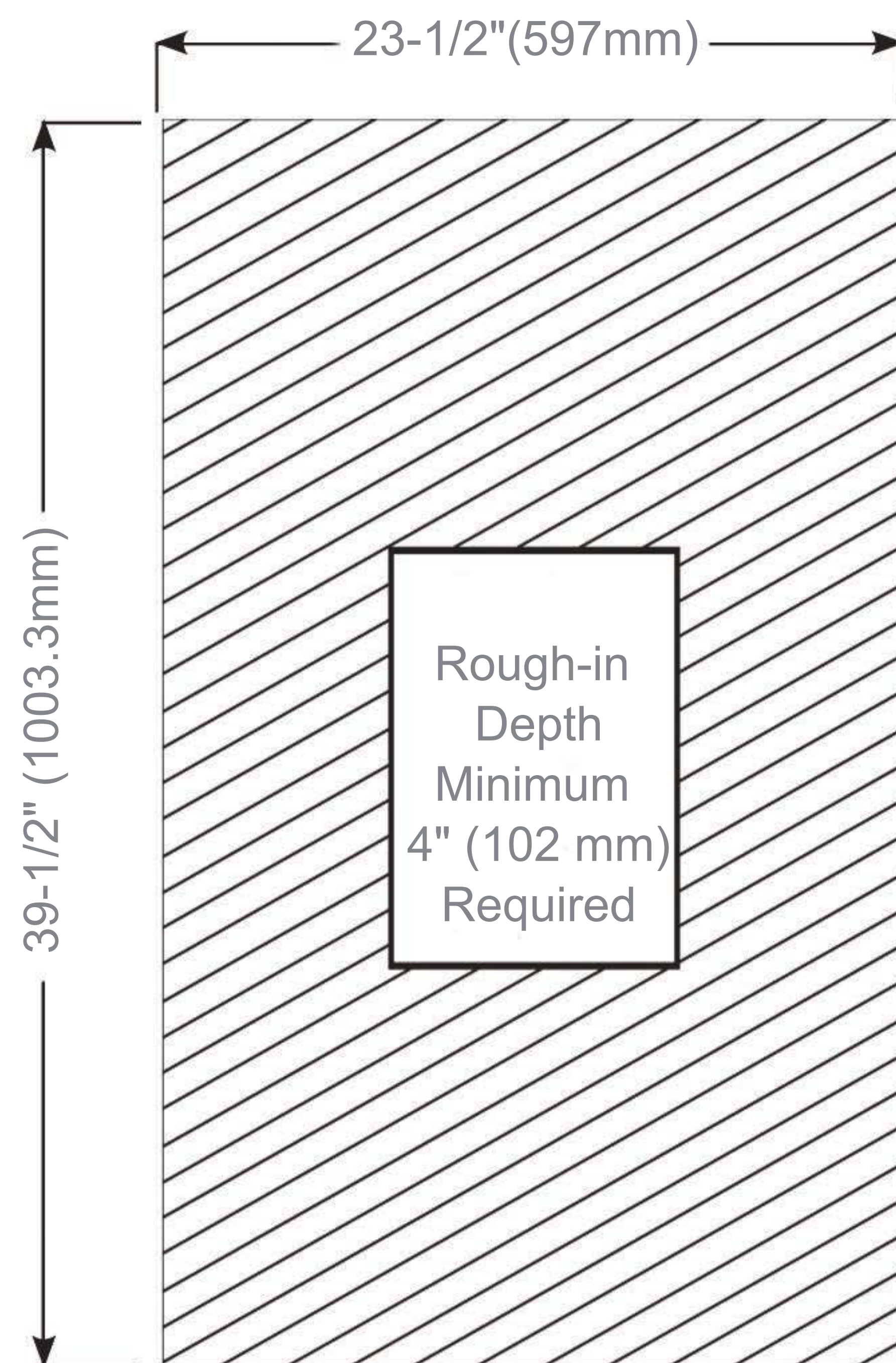

Rough-in Dimensions

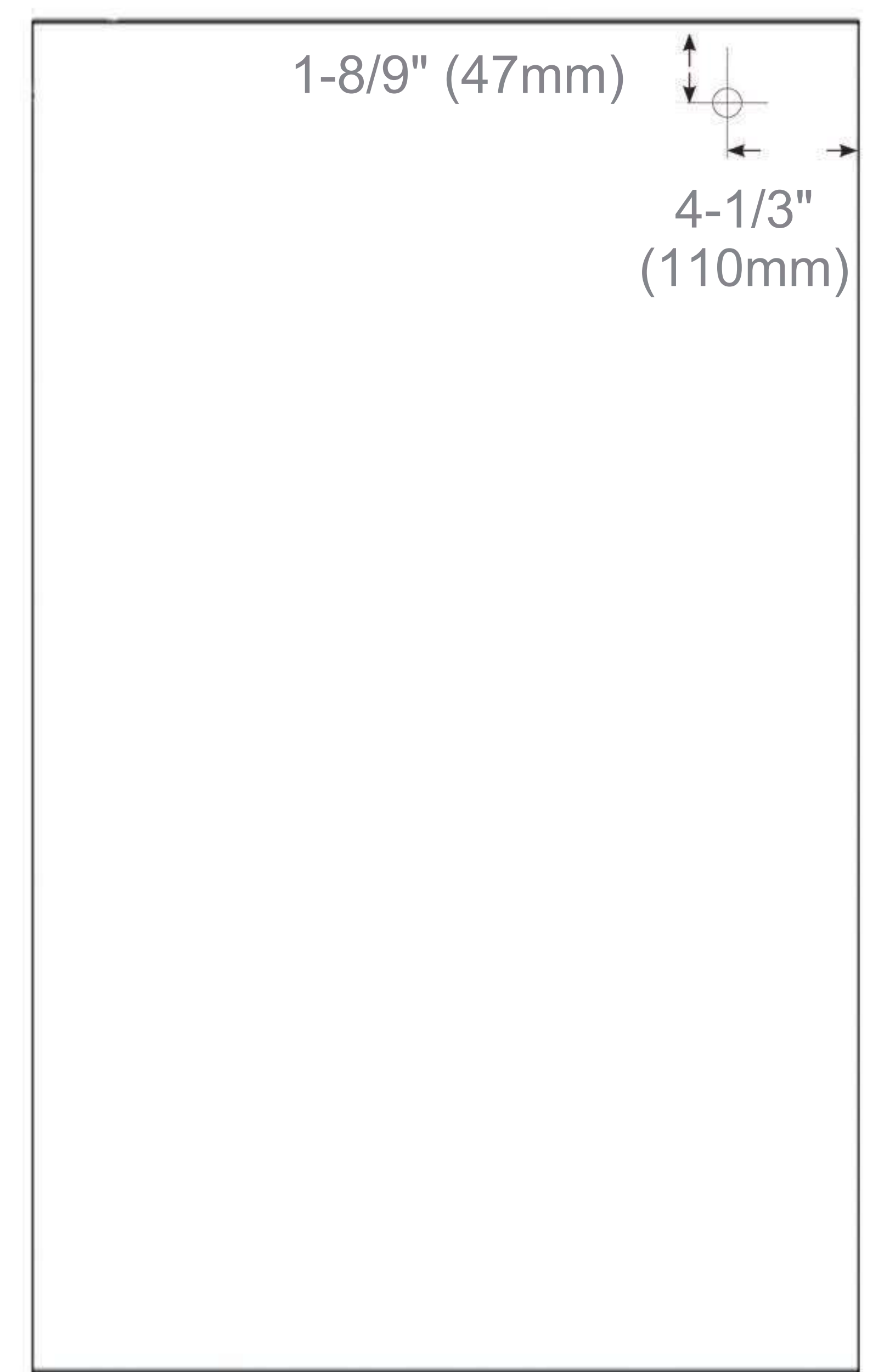

Back of Cabinet - Wire Access Location