

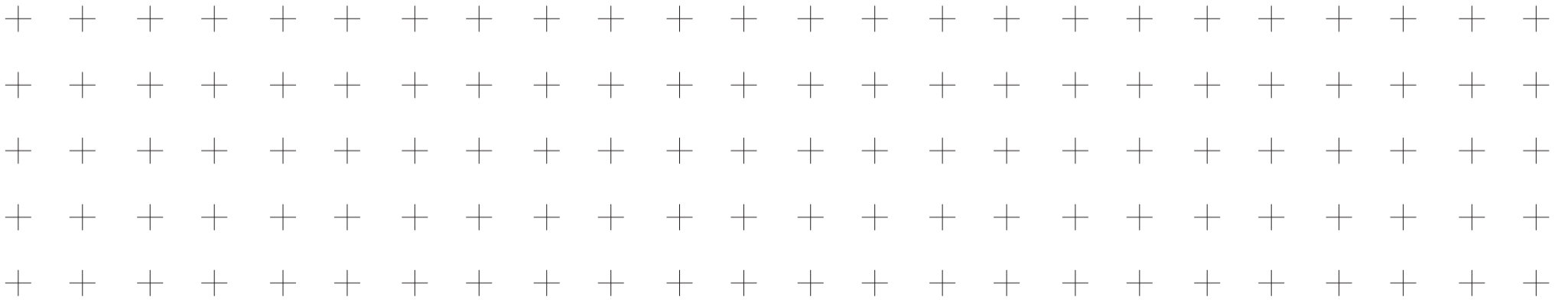

BEAUTIFUL KITCHENS THAT FIT THE WAY YOU LIVE

CREATE YOURS TODAY WITH OUR DIY KITCHEN MASTER PLANNER



WWW.UCANDOIT.CO.ZA

 FOLLOW US FOR USEFUL PRACTICAL CONTENT FACEBOOK.COM/UCAN.DIY



DIY MASTER SKETCH PAD

USE OUR SKETCH PAD TO LAYOUT YOUR KITCHEN.
TRY DIFFERENT CONFIGURATIONS TO FIND THE ONE THAT WORKS FOR YOUR FAMILY.

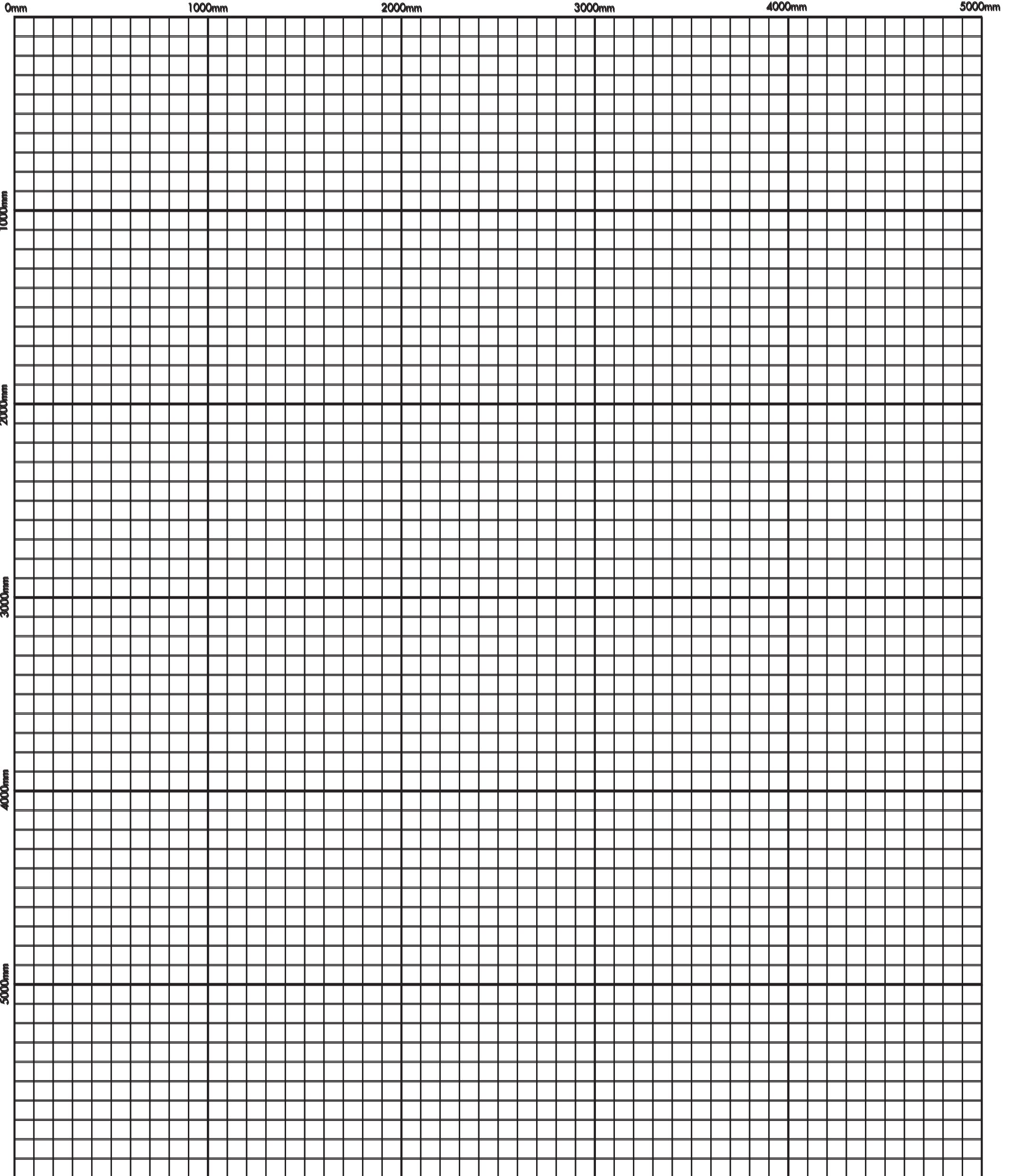

SCALE: Each small square represents 100mm. Each large square represents 1m (1000mm)

DIY MASTER MEASURE UP GUIDE

TWO EASY STEPS TO MEASURE YOUR KITCHEN ACCURATELY TO GIVE IT THE PERFECT FIT. WE ALSO EXPLAIN HOW TO USE THE SKETCH PAD AND MODULE SHEET.

MEASURE UP YOUR KITCHEN

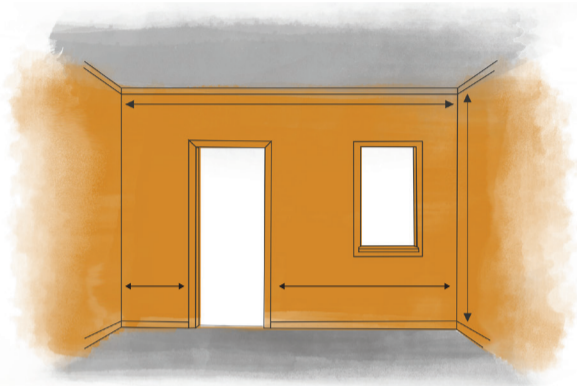

STEP 1

Start by measuring from the floor to the ceiling, then the distance between walls, and from the corners to the doors.

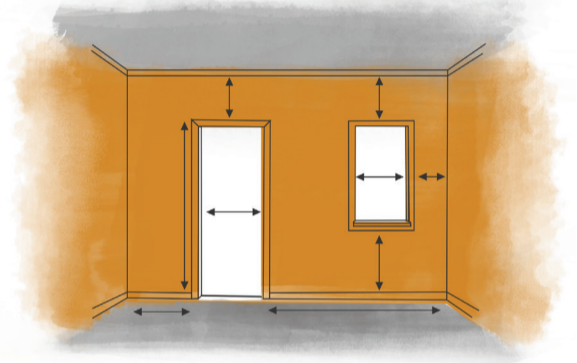

Measure each window and their distance from the floor, the ceiling and the corners of your room. Do the same for the doors.

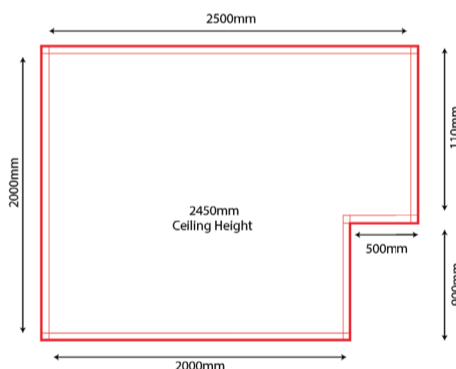

Sketch a diagram of your kitchen, with all the walls, windows, entrances and exits shown. Measure all the sides that you have sketched in cm or mm. Measure the ceiling height.

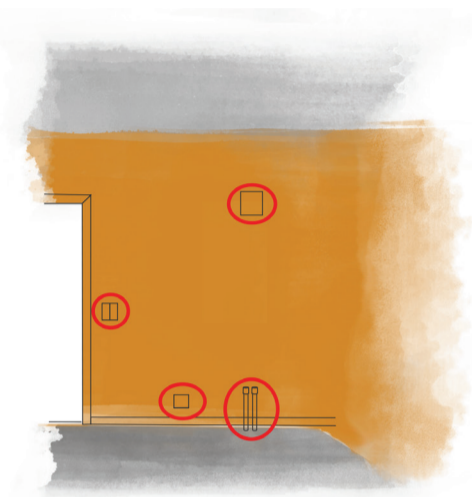

STEP 2

Mark down anything that sticks out into the room such as ventilation shafts and pipes. Note the position of your drains and water supply. If you are planning to relocate these, mark their new positions. Measure and note the position of existing power outlets and light switches. Mark where you would like new ones to be.

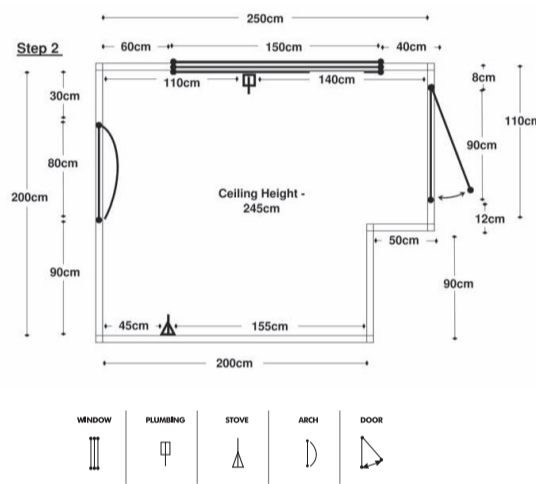

Sketch all doors and windows, plug, stove, light, plumbing and other electrical or plumbing points that need to be marked. Start at the top left hand corner of your sketch pad and continue clockwise around the room until each point has been accurately measured (include the frame in the measurements for the windows and doors). Also measure the respective distances from the corner of the walls.

WHAT YOU NEED

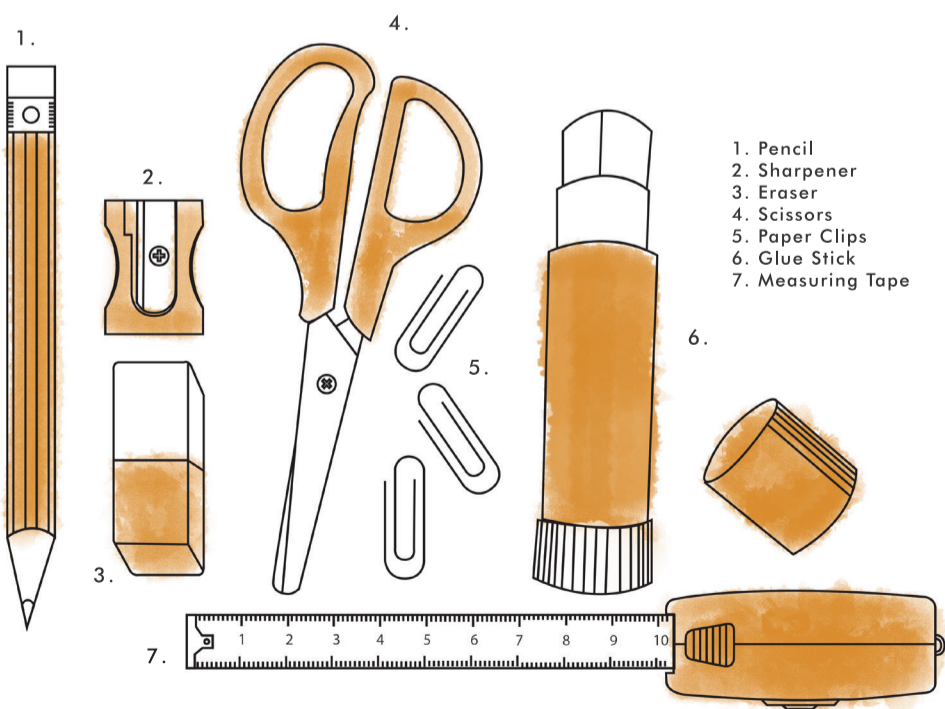

HOW IT WORKS

STEP 1

Measure your kitchen according to the guide above. Sketch your kitchen onto the *DIY Kitchen Master Sketch Pad* provided. Make sure that you sketch it to the scale provided on the sketch pad. That is: each small square represents 100mm and each large square represents 1m (1000mm).

STEP 2

Once you've sketched up your kitchen, cut out all the units on your *DIY Kitchen Master Module Cut Sheet*. All units are drawn to the same scale as the *DIY Kitchen Master Sketch Pad*. Starting with the corner units, then the base units, top units, cupboards and finally, the accessories, place the units along the wall of your kitchen sketch, overlapping base and top units where necessary.

STEP 3

Once you've designed your dream kitchen and you are happy with the layout, glue down the units onto the *DIY Kitchen Master Sketch Pad*. You can take this into your nearest select Builders or Game store where one of our consultants will help you turn your dream into a reality. Alternatively, you can take a photo of your kitchen plan and email it to masterplanner@ucandoit.co.za and we will contact you.

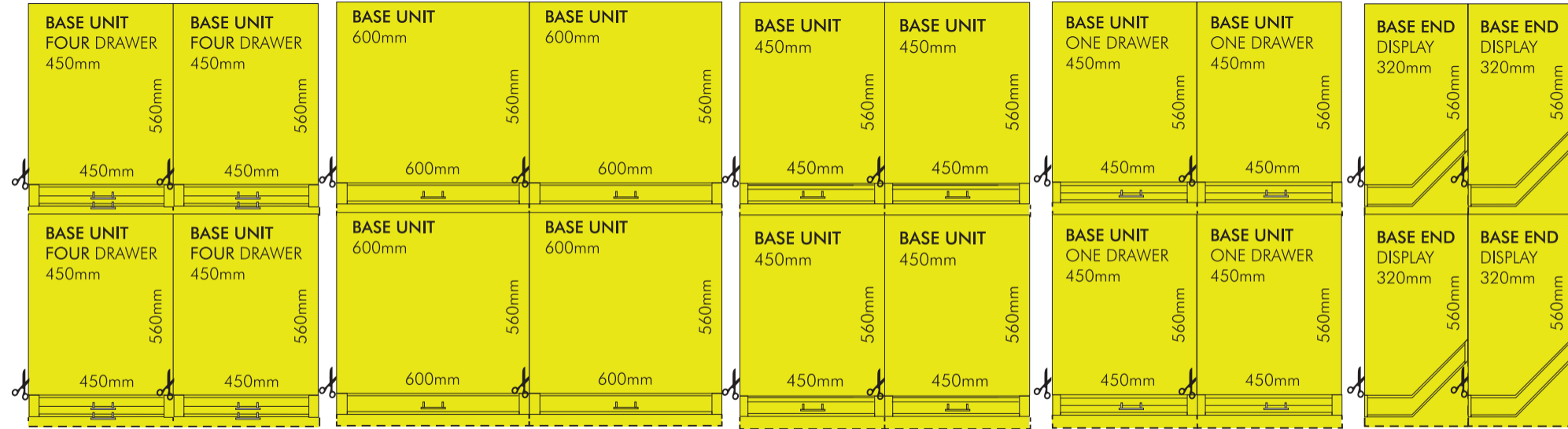

- BASE UNITS
- TOP UNITS
- CUPBOARDS
- ACCESSORIES

TOP UNITS

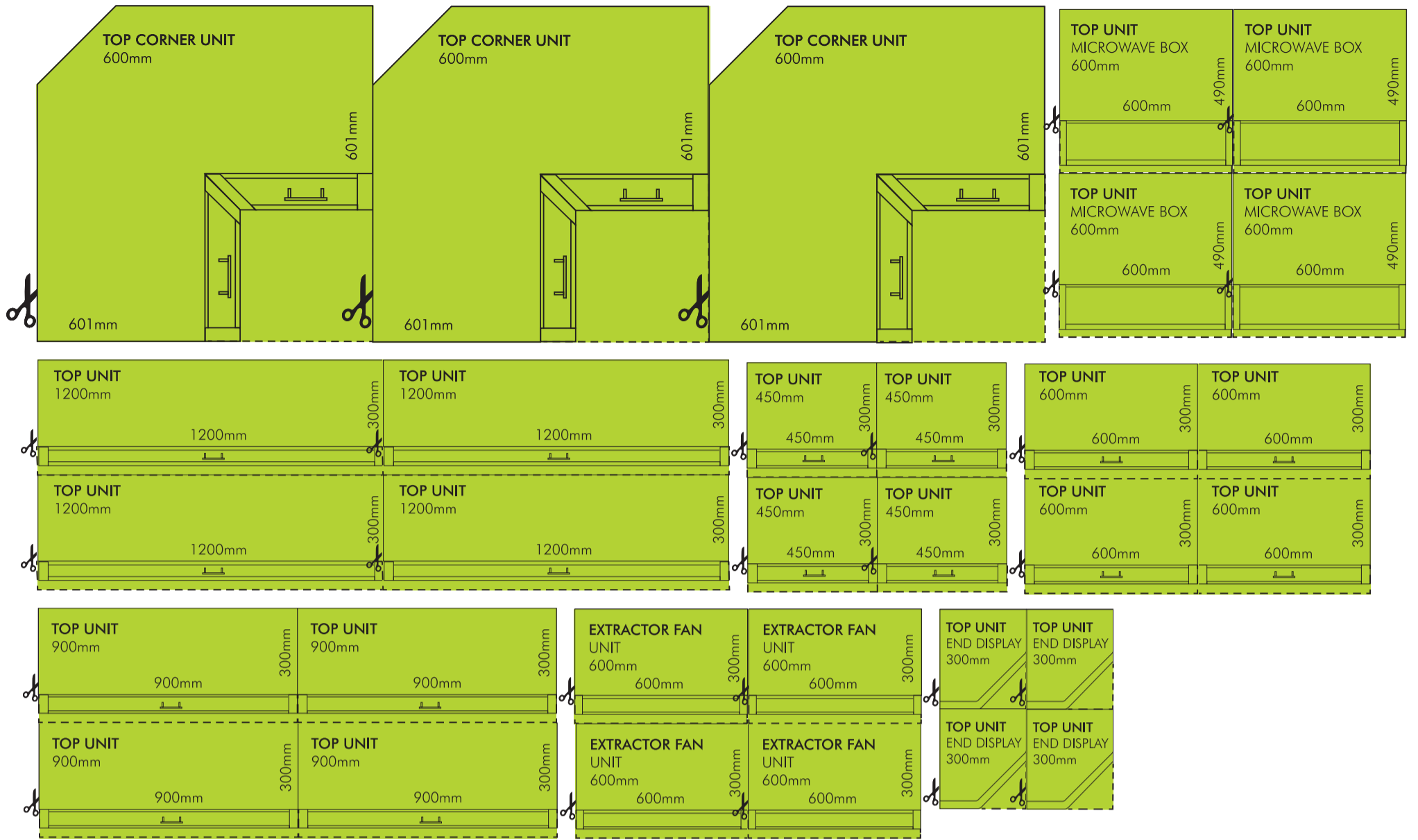

WALK IN PANTRY

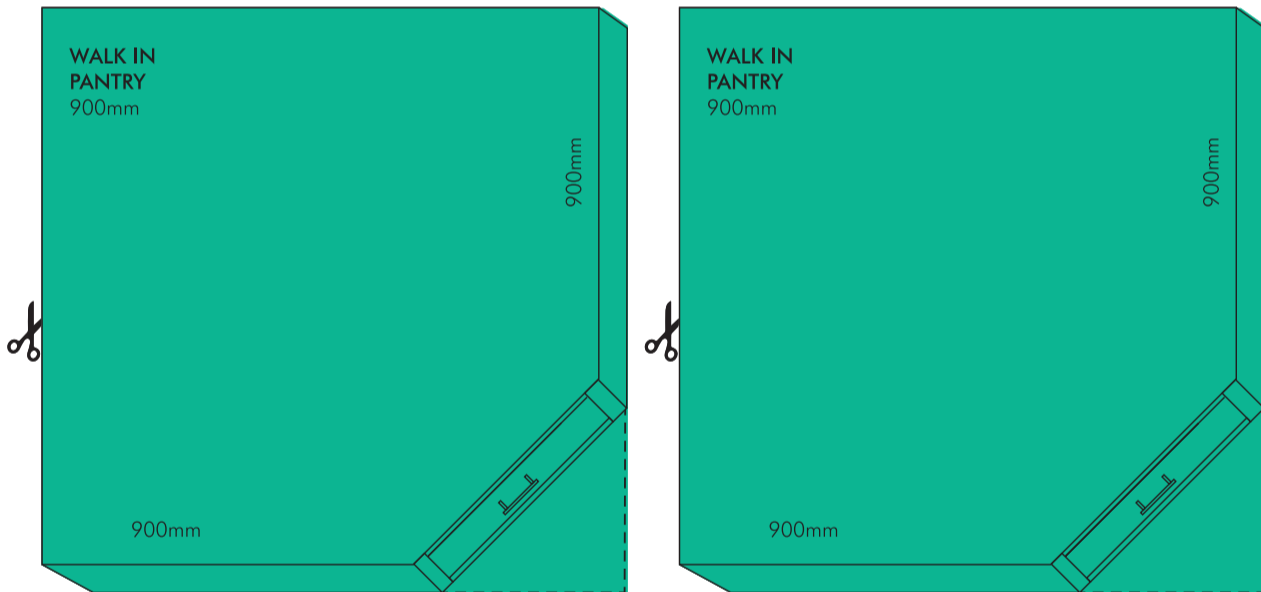

BROOM CUPBOARD

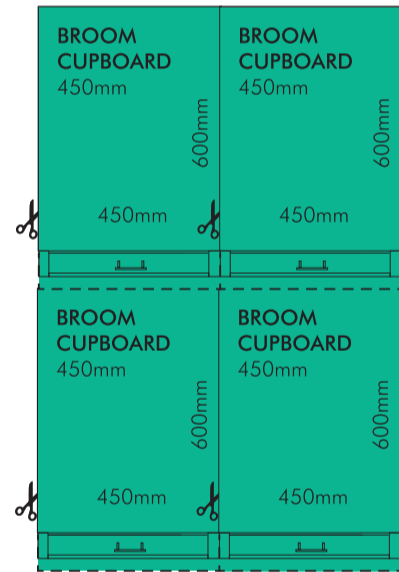

GROCERY CUPBOARD

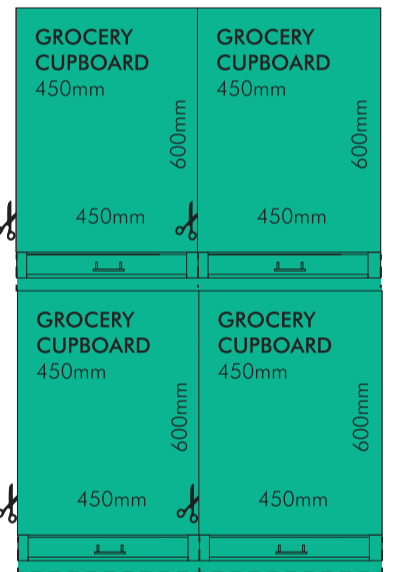

UTILITIES

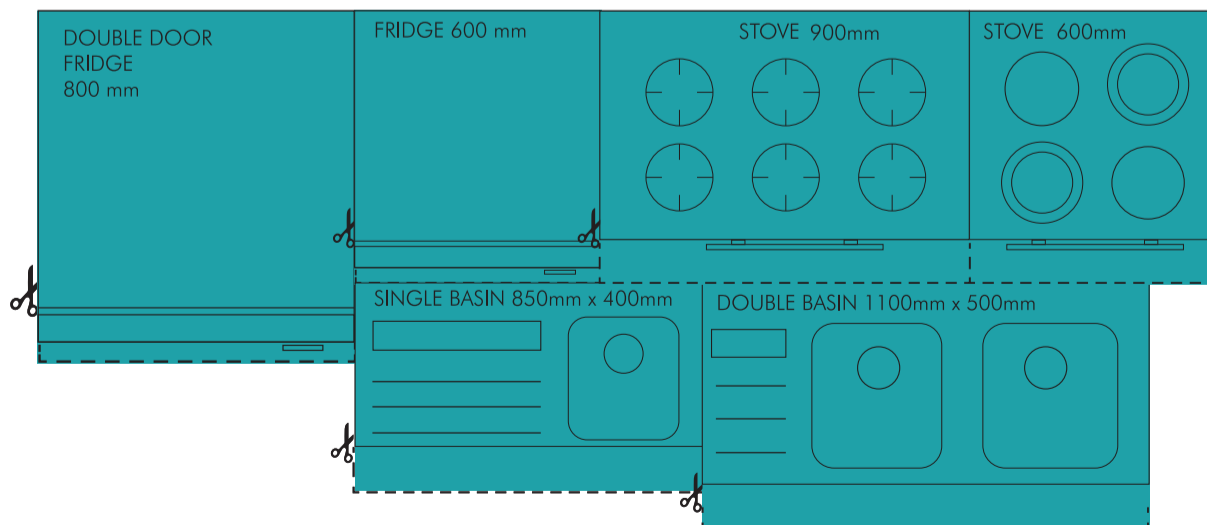

BASE UNITS
 TOP UNITS
 CUPBOARDS
 UTILITIES

WWW.UCANDOIT.CO.ZA

f FOLLOW US FOR USEFUL PRACTICAL CONTENT [FACEBOOK.COM/UCAN.DIY](https://www.facebook.com/ucan.diy)



NEXT STEP:
**SUBMIT YOUR
DESIGN**

SEND YOUR NEW KITCHEN DESIGN TO OUR
DIY KITCHEN SPECIALISTS TO CREATE A 3D RENDER AND QUOTE
masterplanner@ucandoit.co.za

WWW.UCANDOIT.CO.ZA

 FOLLOW US FOR USEFUL PRACTICAL CONTENT [FACEBOOK.COM/UCAN.DIY](https://www.facebook.com/ucan.diy)