

# Element sauna

# NORDIC

## INSTRUCTIONS FOR INSTALLATION

### English

### Corner S1616CV

1635 x 1635 x 2020 mm



EN

### Corner Large S2020CV

2060 x 2033 x 2020 mm



# Table of Contents

<b>1. Preparing for installation</b>	<b>3</b>
1.1. Tools required	4
1.2. Maintenance and cleaning	5
1.3. Disposal	5
1.4. Parts list for Corner S1616CV and Corner Large S2020CV	6
<b>2. Floor plan</b>	<b>8</b>
2.1. NORDIC Corner S1616CV	8
2.2. NORDIC Corner Large S2020CV	8
<b>3. Assembling the cabin</b>	<b>9</b>
3.1. Assembling the base frame	9
3.2. Assembling the cabin walls	9
3.3. Assembling the roof elements	9
3.4. Assembling the benches	9
3.5. Assembling the glass elements	10
3.6. Installing roof trim	10
3.7. Mounting the cover slats	10
3.8. Drill hole for electrical cable	10
3.9. Mounting the light	10
3.10. Installation KIT for heater installation at the bench foot	10
<b>Illustrations for the parts list</b>	<b>11</b>
<b>Assembly illustrations</b>	<b>12</b>

# 1. Preparing for installation

Read these assembly instructions carefully and keep them within reach when using the sauna so that you can look up product information at any time.



These assembly instructions can also be found in the customer service section of our website: [almostheaven.com](http://almostheaven.com).

## Important note:

- Before you begin work, check the parts list to ensure that all the individual parts have been delivered. If you discover any missing parts, notify your dealer within 14 days of receiving the sauna cabin.
- The room that the sauna is installed in must be dry and ensure an appropriate amount of air circulation.
- The floor must be level and even, preferably a stone or tiled floor.
- A minimum room height of 230 cm is required for the cabin installation work.
- A distance of at least 5 cm from the wall must be maintained.
- The inside of the wooden parts used must not be handled with any impregnating material.
- You need an assistant for the installation.
- Wood is a natural product that can swell, shrink or warp, despite good storage. For this reason, some force may be necessary during the installation.
- All screw fittings must be pre-drilled.

**EN**

## Attention!

**The electrical connection may only be performed by a qualified electrician or similarly qualified person.**

## 1.1. Tools required

- Hammer with a wooden head or a mallet
- Cordless screwdriver with bits for cross-head screws and Torx
- Roller tape measure
- Drill bits with a diameter of 3 mm, 10 mm, 20 - 30 mm (for sauna heater power cable)
- Spirit level
- 1.5 mm hexagonal socket wrench
- Utility knife
- Ladder



This symbol indicates tips and useful information



Pre-drill



Nailing



Check the right angle:

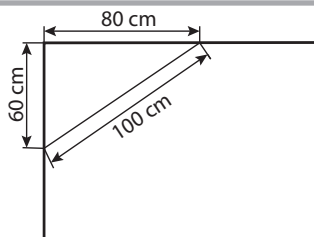

Handle glass with care: Special care must be taken with the edges of the glass – hardened glass can shatter into small pieces in the event of impact. Insert protective cushioning (e.g. cardboard box) under the edge of the glass.

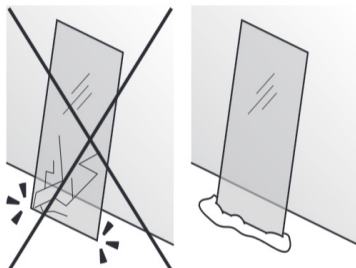

## 1.2. Maintenance and cleaning

- The sauna should be cleaned with a damp cloth. Only use warm water – no cleaning products.
- We recommend heating the cabin once a month if the sauna is not used for a long time.



---

Pitch pockets are not grounds for return, since they can always appear in spruce wood and the depth at which they lie cannot be detected during the sorting-out process.

If these are just under the surface, heat can cause them to soften and “bleed”.

The leaking pitch can be removed with a rag soaked in acetone. If only droplets of pitch occur, allow these to harden and then carefully scrape them off with a knife.

---

## 1.3. Disposal



- Dispose of packaging materials in accordance with the applicable waste disposal regulations.
- Used devices contain reusable materials as well as hazardous substances. Therefore, do not dispose of your used device with household waste, but do so in accordance with the locally applicable regulations.

## 1.4. Parts list for Corner S1616CV and Corner Large S2020CV

Illustrations for parts list on page 11 (following the last language of the instructions)

No.	Name	Pcs	Dimensions (mm)	
			S1616CV	S2020CV
<b>Base frame</b>				
1	Base frame	2	587x68x43	1 1012x68x43
2	Base frame	1	1567x68x43	1 1992x68x43
3	Base frame ventilation aperture	1	1567x68x43	1 1947x68x43
<b>Wall elements</b>				
4	Wall elements 510	2	1900x510x75	
4	Wall elements 935	2	1900x935x75	3 1900x935x75
5	Electrical element 510	1	1900x510x75	
5	Electrical element 935			1 1900x935x75
6	Ventilation element 510	1	1900x510x75	
6	Ventilation element 935			1 1900x935x75
<b>Corner posts</b>				
7	Corner post A			1 1949x85x45
8	Corner post E			1 1949x87x81
9	Corner post EP			1 1949x87x81
10	Corner post F			1 1949x95x69
11	Corner post C	1	1949x93x84	
12	Corner post D	1	1949x93x84	
13	Corner post G	1	1836x77x76	1 1836x77x76
14	Corner post H	2	1836x77x44	1 1836x77x44
<b>Roof elements</b>				
15	Roof element	1	1597x995x64	1 2022x1027x64
16	Roof element	1	1597x602x64	1 2022x968x75
17	Roof frame	1	1567x45x32	1 1992x45x32
17	Roof frame	1	1521x45x32	1 1864x45x32
17	Roof frame	1	459x45x32	1 966x45x32
17	Roof frame	1	541x45x32	
18	Roof rim	2	1634x95x15	1 2060x95x15
18	Roof rim	1	1383x95x15	1 2033x95x15
18	Roof rim	2	657x95x15	1 1376x95x15
18	Roof rim			1 1088x95x15
18	Roof rim			1 1059x95x15
<b>Corner covers</b>				
19	Inner roof corner trims	1	1447x18x15	1 1868x18x15
19	Inner roof corner trims	1	1428x18x15	1 1848x18x15
19	Inner roof corner trims	2	544x18x15	2 966x18x15

No.	Name	Pcs	Dimensions (mm)	Pcs	Dimensions (mm)
			<b>S1616CV</b>		<b>S2020CV</b>
20	Inner corner trim	3	1025x20x20	2	1025x20x20
21	Outer corner covers	2	1900x77x15	2	1900x77x15
22	Outer corner covers	1	1900x64x15	1	1900x64x15
23	Outer corner covers	1	1900x64x15		
24	Outer corner covers			1	1900x40x15
	<b>Glass front</b>				
25	Aluminium U-profile	2	317x22x12	1	921x22x12
25	Aluminium U-profile			2	309x22x12
26	Glass	2	1939x327x8	2	1939x319x8
26	Glass			1	1939x943x8
26	Glass door	1	1897x600x8	1	1897x600x8
27	Spacer strip above glass door	1	610x20x8	1	610x20x8
26	Glass door	1	1897x600x8	1	1897x600x8
27	Spacer strip above glass door	1	610x20x8	1	610x20x8
28	Door handle set	1	300x158x30	1	300x158x30
29	Door hinges	2		2	
	<b>Interior fittings</b>				
30	Upper sauna bench	1	1440x500x90	1	1865x600x90
30	Upper sauna bench	1	500x345x90	1	582x500x90
30	Lower sauna bench			1	1865x400x90
31	Bench foot	1	1143x510x10	1	1143x510x90
32	Foot step	1	690x500x90		
33	Feet, foot step	4	431x90x28		
34	Bench screen	1	1400x402x42	1	1828x402x42
35	Backrests	1	1400x270x36	1	1828x270x36
35	Backrests	1	800x270x36	1	1136x270x36
36	Bench support slat	1	495x99x29	1	595x99x29
37	Bench support slat			2	950x99x29
38	Bench support slat	1	700x90x29	1	950x90x29
39	Bench support leg			1	845x68x44
39	Bench support leg			1	395x68x44
	<b>Accessories</b>				
40	Ventilation slit	1	260x87x20	1	260x87x20
41	Light (SAS21060T)	1	200x100x65	1	200x100x65
42	Installation material	1		1	
43	Kit for heater mounting on bench foot	1		1	
44	Assembly instructions	1		1	

## 2. Floor plan

### 2.1. NORDIC Corner S1616CV

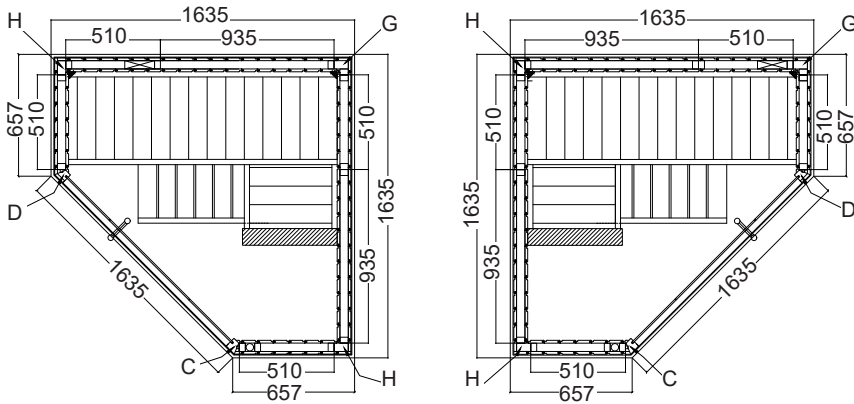

### 2.2. NORDIC Corner Large S2020CV

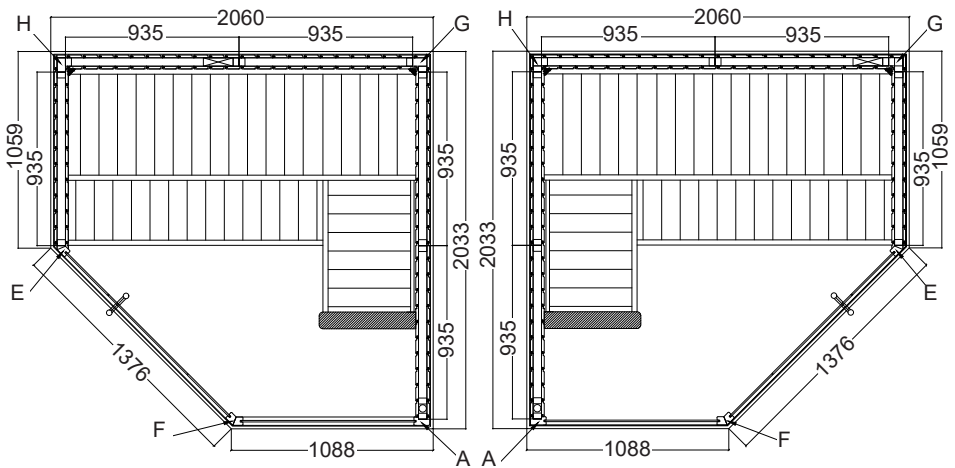



### 3. Assembling the cabin

**ATTENTION!**

Note the floor plans on page 8 as well as the illustrations starting on page 12.

#### 3.1. Assembling the base frame

Start with the base frame and screw it to the corners. Move the base frame to the final position of the sauna.

#### 3.2. Assembling the cabin walls



Note the outside/inside of the wall elements.

Make sure the ventilation element is correctly positioned. It must be placed diagonally opposite the heater.

Start assembling the wall elements with the ventilation element and screw it to the corner post (G, H). The other wall elements are connected by tongue and groove and are fixed by mounting the roof frame. Check the right angles (see tip on page 4).

Mount the multiclips on the front side of the wall element and on the corner posts (C, D, E(EP), F). Make sure that the multiclips are correctly aligned – the corner posts are connected to the wall elements from top to bottom.

Fit the ventilation slider.

#### 3.3. Assembling the roof elements

Insert the roof elements and screw them to the cabin walls. Note the cable outlet. It may be necessary to mount the rail for the glass front on the opposite side.

#### 3.4. Assembling the benches

Mount the bench support slats on the side wall elements. Connect the angle bench to the sauna bench using M10 x 120 screws. Screw the adjustable feet into the bench foot. Fix the bench foot to the angled bench by tightening up the lock and screw the bench foot to the side wall.

Assemble the bench screen and the backrest.

### 3.5. Assembling the glass elements

Fit the aluminium U-profiles on the glass elements and install the glass elements in the cabin.

Note when installing the glass element that the holes drilled for the door hinges determine which way the door opens.



---

Note when installing the glass element that the holes drilled for the door hinges determine which way the door opens.

Bond the aluminium U-profiles to the floor with silicone or assembly adhesive.

---

Mount the spacer strip above the glass door.

When installing the door fittings, make sure that the door opens to the outside.

Screw the two door fittings to the glass element first, making sure that the fittings are aligned straight. Align the fittings by adjusting / turning the two plastic inserts.

The door handles are screwed together from the inside. Attach plastic washers on the stainless steel handle

Fit the door magnet and sleeve plate.

### 3.6. Installing roof trim

Mount the corner brackets to the roof trim strips. Then screw the roof trim strips to the roof element.

### 3.7. Mounting the cover slats

Fasten the inner roof corner trims, the inner corner trims and the outer corner covers using nails.

### 3.8. Drill hole for electrical cable

### 3.9. Mounting the light

### 3.10. Installation KIT for heater installation at the bench foot

Only required if the sauna heater is mounted on the bench foot in order to maintain the safety distances.

### Pictures of Parts

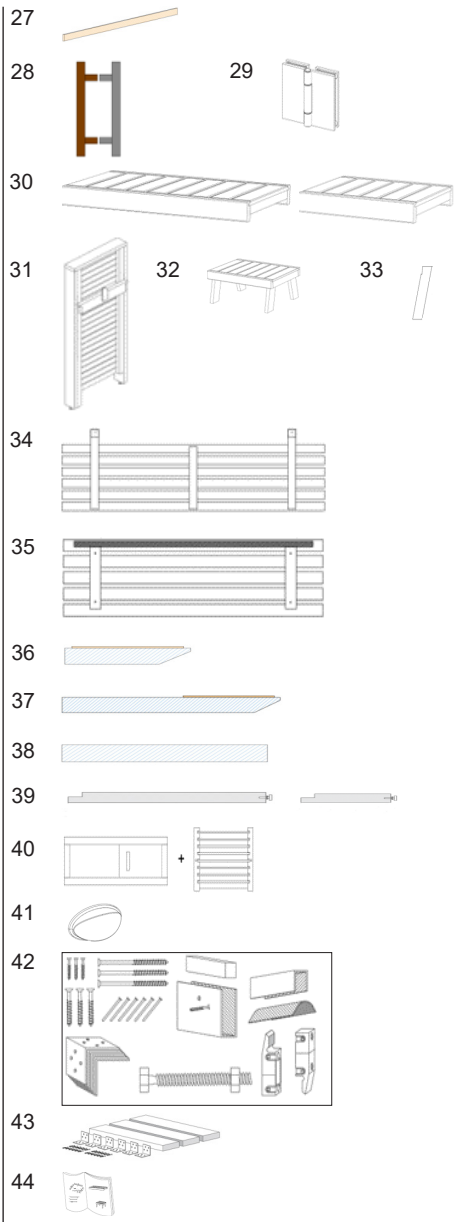
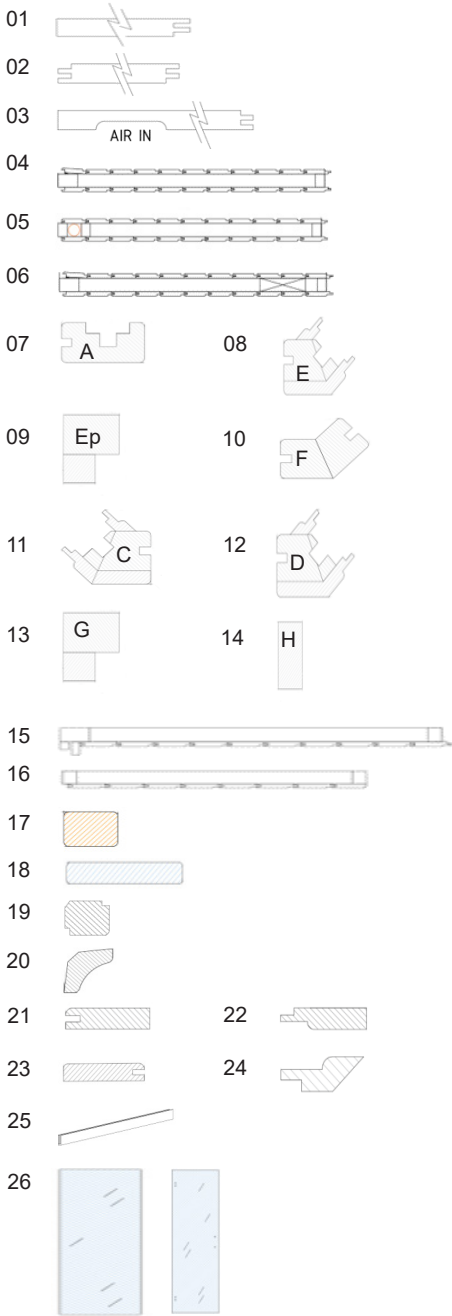

3.1.

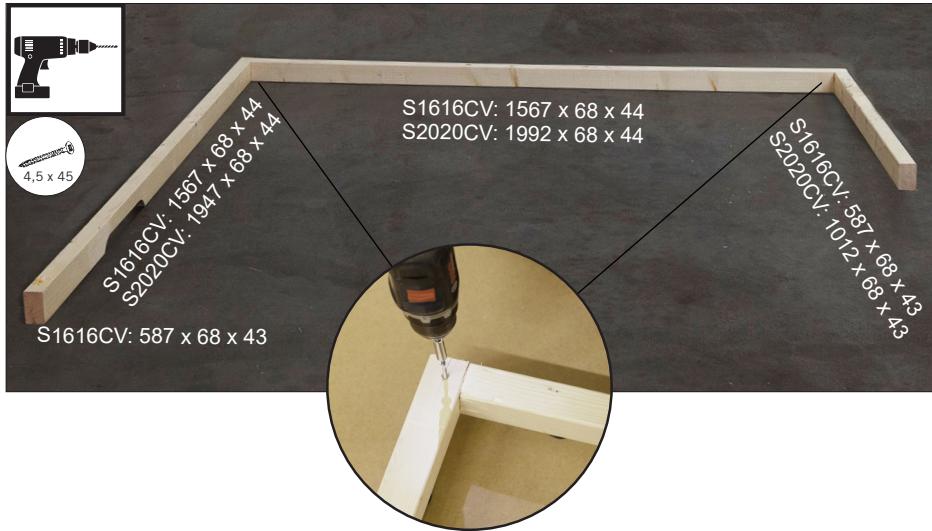

3.2.

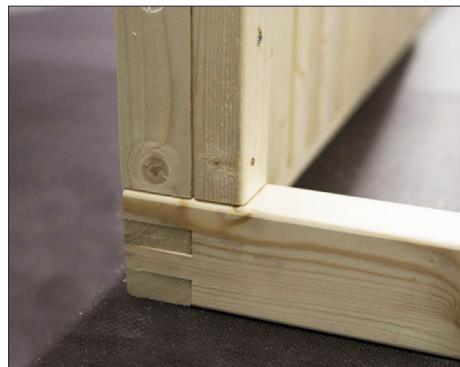
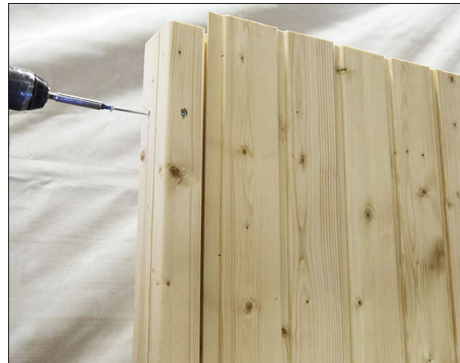

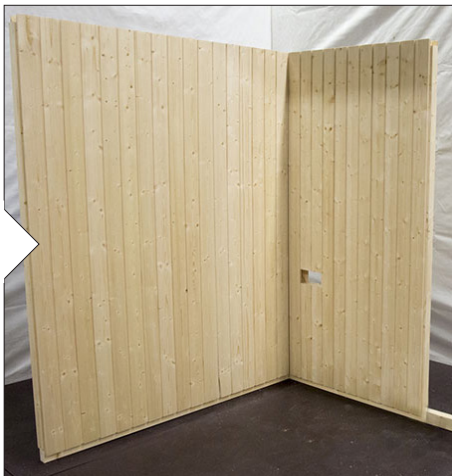
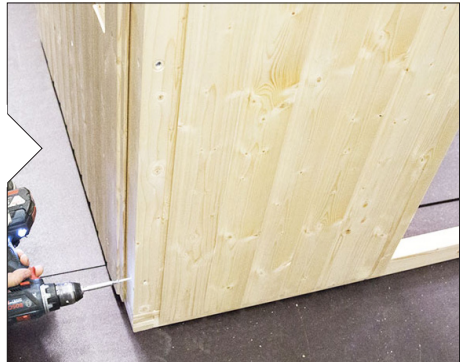

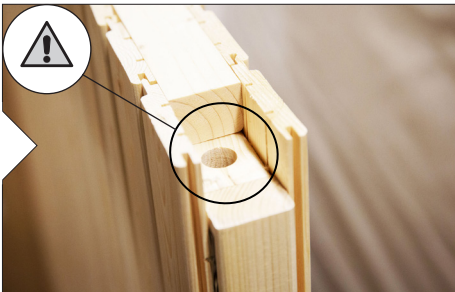
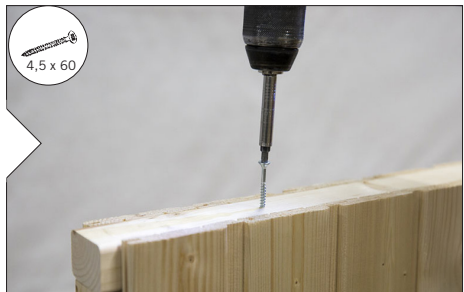



Multiclip

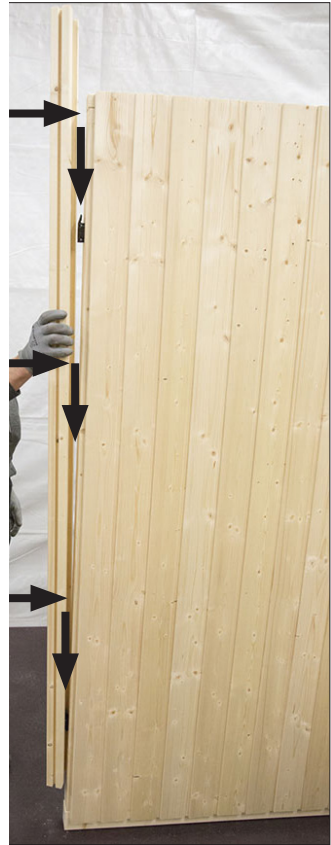
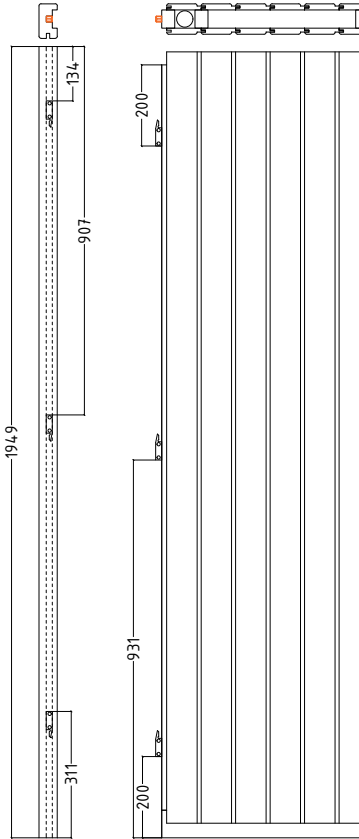

3.3.





3.4.

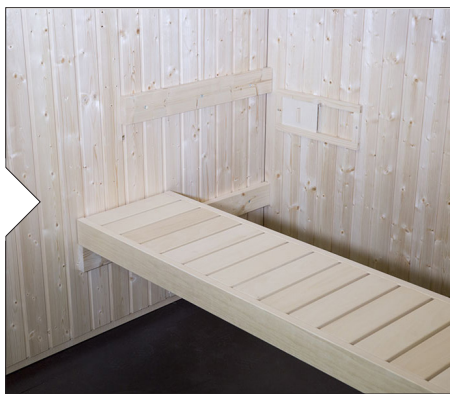

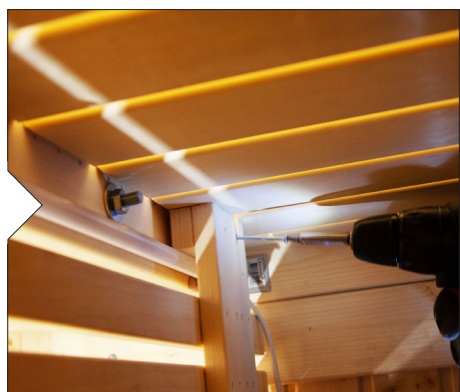

3.5.

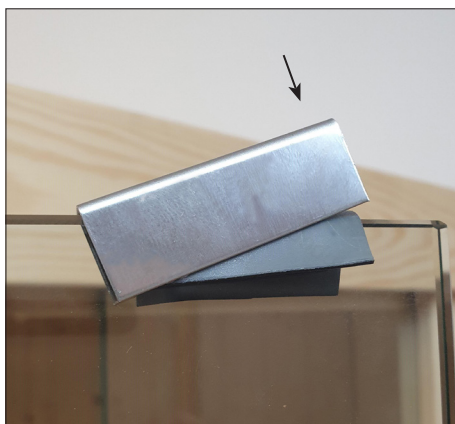
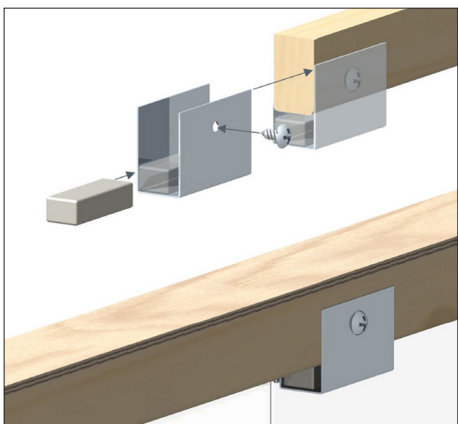
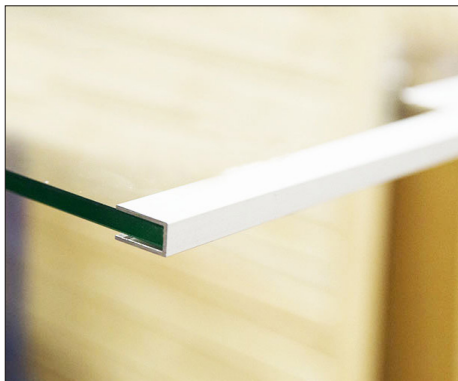

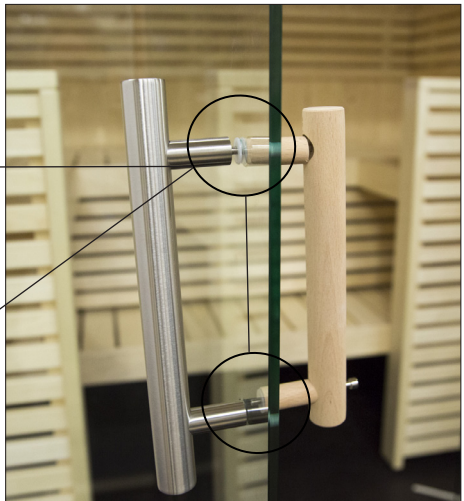
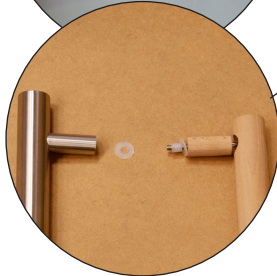
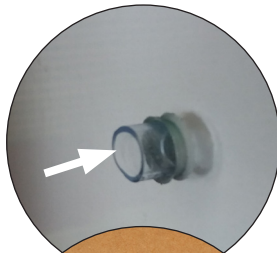
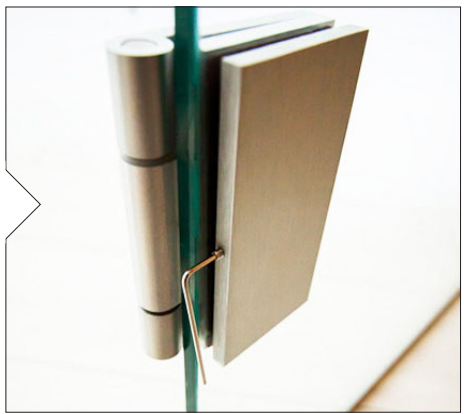
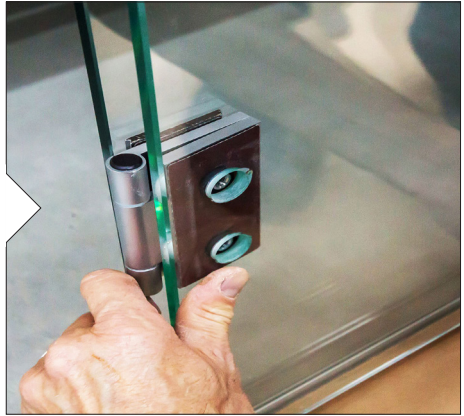

3.6.

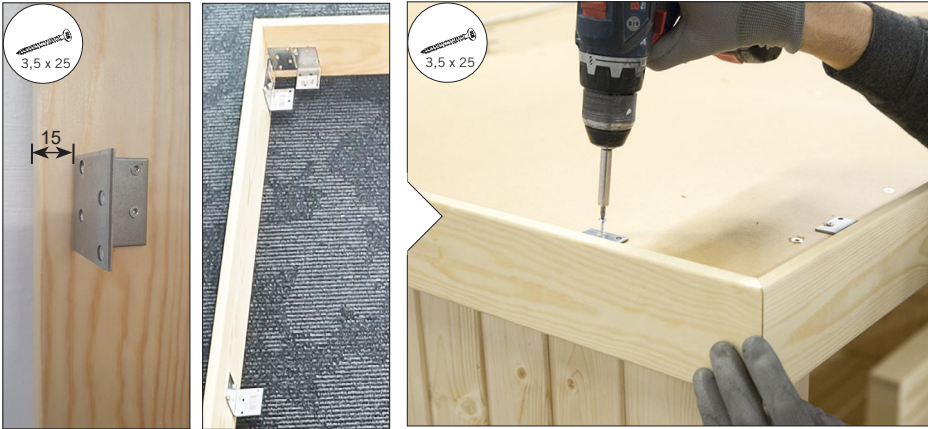

3.7.





3.8.

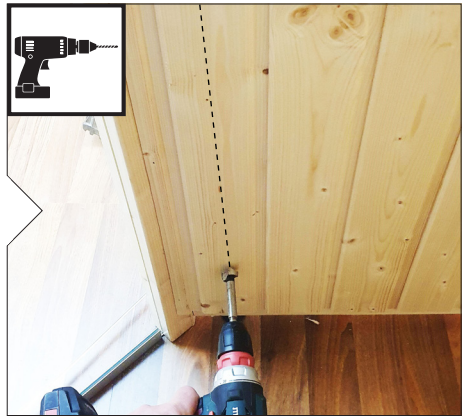
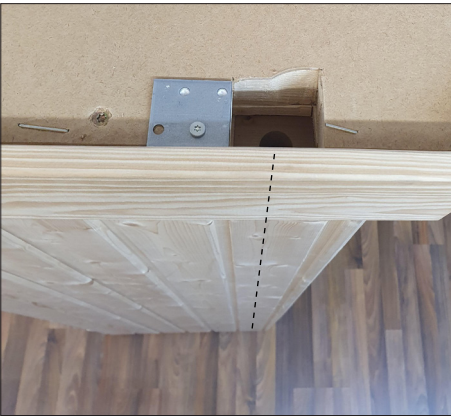

3.9.



3.10.

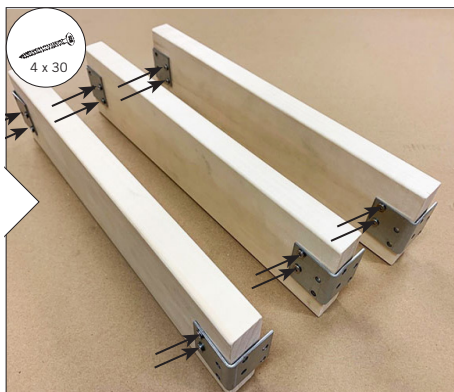
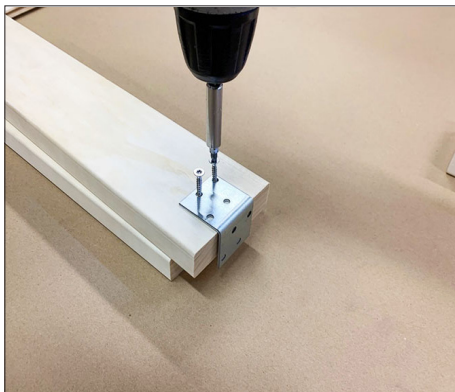



Almost Heaven Saunas, 11261 James Street, Holland, MI 49423  
Office 888.355.3050 | [sales@almostheaven.com](mailto:sales@almostheaven.com) | [www.almostheaven.com](http://www.almostheaven.com)