

User's Manual

MARGARITA & SLUSHIE MACHINE



- Before use of the product, be sure to become familiar with this manual.
- Keep the manual in a convenient place for quick and easy reference.
- The product design is subject to change for performance enhancement without prior notice.

INTRODUCTION

Congratulations ! You are the owner of not only the finest slushie machine but also the most versatile of its kind.

Please read all sections of this manual thoroughly to familiarize yourself with all aspects of the unit.

WARRANTY AND PACKAGING

1 Year parts warranty on all the parts.

For warranty keep the original packaging: wooden crate , carton box and polystyrene. Will not be authorized any return without original packaging.

INSTALLATION

NOTE: Note this appliance is not intended for use by persons(including children) with reduced physical, sensory or mental capabilities, or lack of experience and knowledge, unless they have been given supervision or instruction concerning use of the appliance by a person responsible for their safety.

Children should be supervised to ensure that they do not play with the appliance.

Type Y attachment

If the power supply cord is damaged , it must be replaced by the manufacturer or its service agent or a similar qualified person in order to avoid a hazard.

1. Remove wooden crate and carton and other packing materials and keep them for possible future use .

CAUTION! When handling the machine never grip it by the tanks/bowls or cooling cylinders .The manufacturer and supplier will NOT be held responsible for any damages which may occur through incorrect handling.

2. Inspect the uncreated unit for any possible damage

1) If any damage, please call the delivering carrier immediately.

2) If the power cord is damaged, it must be replaced by the manufacturer, service agent or a qualified electrician in order to avoid any hazard.

3. Install the unit on a counter top that will support the combined weight of the dispenser and product, bearing in mind what is stated in the preceding point 1, CAUTION paragraph.

4. When installing the unit allow for adequate air space. Facing the unit from the dispensing side, a minimum of 6 inches of free air space should be allowed at the rear and on each side of the machine.

5. Ensure that the foot pieces are screwed tight into the base of the machine .

6. Clean and sanitize the unit according to the instructions in this manual . See the "CLEANING" paragraph .

7. Fill the bowls(tanks) with mix above the recommend level mark .

8. All food touching parts are safe for your health. The machine can be used to chill juice, coffee and make slushie. After a business day, if you still have mixture inside switch the unit on cold drink mode to keep product refrigerated during the night.

9. Before plugging the unit in check to see if the voltage is correct and the same as indicated on the data plate. Plug the unit into a grounded, protected single phase electrical supply according to the applicable electrical codes and the specifications of your machine. Should you prefer to connect the unit directly to the mains system.

Warning!! Failure to provide proper electrical ground could result in serious electrical shock hazard.

10. Please do not operate the machine without mixture inside the bowl, no mix or incorrect mix will cause damage to the machine.

DON'T RUN WITH WATER ONLY, the water will freeze.

Note

The freezing time of slushie depends according to the composition of the mixture the ambient temperature and the initial product temperature.

MACHINE PARAMETERS

Bowl(n)	1	2	3
Capacity (L)	1x12L/15L	2x12L/15L	3x12L/15L
Power Supply	110V/60Hz 220V 50/60Hz	110V/60Hz 220V 50/60Hz	110V/60Hz 220V 50/60Hz
Power(W)	500W	700W	900W
Net Dimension(mm)	305x475x700	365x475x700	545x475x700
Packing Dimension(mm)	375x545x770	435x545x770	616x545x770
N.W (kg)	30	40	55
G.W (kg)	40	50	70

Cleaning instructions

1. Drain all slushie out of machine with auger running (wash mode). When machine is nearly empty , pour water in the tank and empty.
2. Fill again the tank with 2 gallons(7 Liters) of water and empty.
3. Add again 2 gallons(7 Liters) of water and add beverage dispenser sanitizer if available (following the Instruction of the producer of the sanitizer)
4. Drain the unit , then fill the unit with 2 gallons(7 Liters) water, run auger in wash mode.
5. Drain again the unit.
6. Take off tank, auger helix and gasket and faucet wash with vessels detergent rinse and dry all the parts.
7. Lubricate with food grade lubricant (vaseline) the back gasket and the internal part of the bowl in contact with the gasket , the faucet piston and its gaskets as well the internal part of the bowl in contact with the piston
8. Put all the parts back on , now you can store or reuse the unit.

Please do not operate the machine without mixture inside the bowl, no mix or incorrect mix will cause damage to the machine.
DONT RUN WITH WATER ONLY, the water will make hard ice and spoil the mixer .

Warning!! Failure to provide proper electrical ground could result in serious electrical shock hazard.

Note!

The freezing time of slushie depends according to the composition of the mixture the ambient temperature and the initial product temperature.

Safety Instructions



Important

You must check the electrical rating on the nameplate of the product. The nameplate is attached on the rear of the product. The nameplate specification has priority over information in this manual.

- Be sure to use the grounded consent.
- Do not move the product by pulling the power plug.
- Do not connect multiple products to a single power outlet.
- Do not forcibly bend the power plug or place any heavy material on it.
- Do not contact the power plug with wet hands.
- Do not install the product in a humid, dusty, or water splashing place.
- Do not install the product on a weak or uneven floor.
- Do not insert your finger or other materials into the panel .
- When moving the product, be careful not to slip and fall.
- When not using the product for a long time, remove the power plug from the outlet.



- **WARNING!** When repairing the product or replacing the parts, remove the power plug from the outlet.



- **WARNING!** This machine has many sharp edges that can cause severe injuries.



- **WARNING!** This machine must NOT be installed in an area where a water jet or hose can be used. NEVER use a water jet or hose to rinse or clean the machine. Failure to follow this instruction may result in electrocution.

Control System

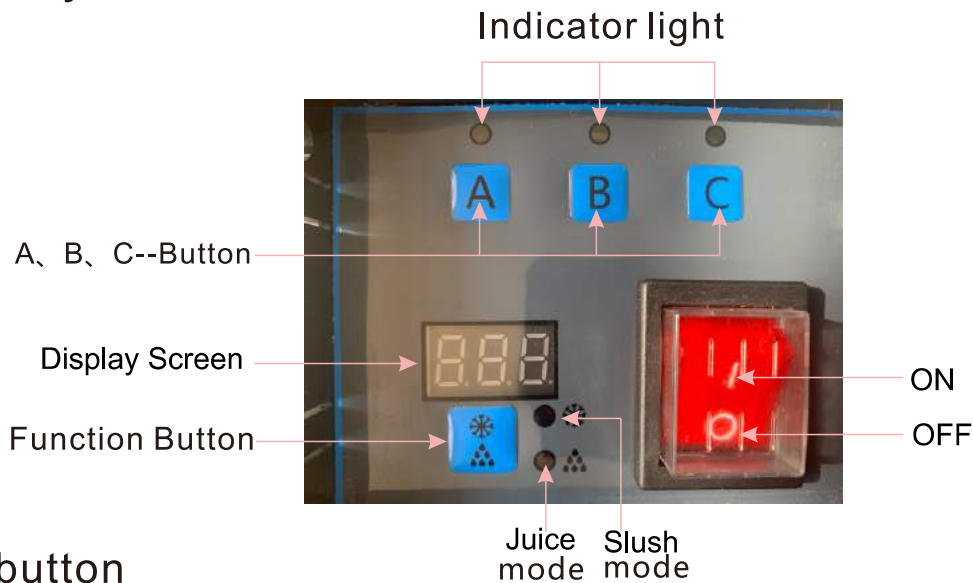

1. A B C button



A is the bowl on the left , B middle bowl ,C is the bowls on the right

Model 1 bowl : Bowl A is active (B and C are not active)

Model 2 bowls: Bowls A and B are active (C is not active)

Model 3 bowls : Bowls A, B and C are active

2. Power switch



"|" position- ON: in the "|" position power is turned on to all functions
 "O" position- OFF: in the "O" position power is turned off to all functions

3. Function Button



Press the function button can switch working mode between Slush mode, Juice mode, Wash mode

Slush mode : Make slush ,product temperature $-1 \sim -3^{\circ}\text{C}$ ($26.6 \sim 30.2^{\circ}\text{F}$)

Juice/Night mode :Make soft (refrigeration) drink, product temperature $3 \sim 7^{\circ}\text{C}$ ($37.4 \sim 44.6^{\circ}\text{F}$)

WASH mode :Only spiral motor operates ,compressor not working



SLUSH MODE



JUICE/NIGHT MODE



WASH MODE

Note: At night can turn on machine to Juice/Night mode to keep mix fresh

4. Independent control button



"I" position- ON: The spiral motor operates
"O" position- OFF: The spiral motor turned off

Note: Independent control button can control each bowl separately ,for 3 bowls machine at least let 2 bowls running at same time ,don' t only running 1 bowl .Otherwise machine easy got frozen and blocked .

SLUSH viscosity setting (Slush Mode)

Adjusting the slush viscosity: The optimal slush viscosity is set by the manufacturer. To change the viscosity, rotate the control bolt on the rear of the product as follows:

- To make thicker slush, rotate the control bolt to the left (counter-clockwise).
- To make watery slush, rotate the control bolt to the right (clockwise).

Note: Viscosity setting depend on material ,don' t setting the viscosity level too thicker ,otherwise machine easy got frozen and blocked .

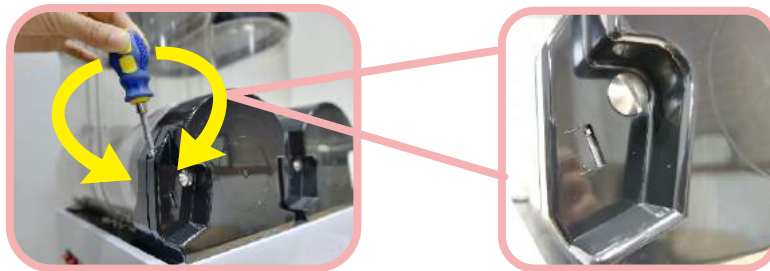

Drink temperature setting (Juice Mode)

Turn on machine to Juice mode ,then machine can use as cold drink machine, can keep mixture temperature at 3°C(37.4°F),5°C(41°F),7°C(44.6°F), 9°C(48.2°F),11°C(51.8°F).

The optimal temperature is set by the manufacturer.

During juice mode ,Press A,B,C button can adjust the temperature to 3°C(37.4°F),5°C(41°F),7°C(44.6°F) ,9°C(48.2°F),11°C(51.8°F) for each bowl

For example, change A bowl temperature:

Press A button ,screen show **5.05** means A bowl temperature setting is 5°C(41°F). press A button again can adjust this temperature ,after adjust wait 3 seconds can save the setting automatically .

Machine Operation

ATTENTION

The equipment is not designed for sugar-free liquids. Make sure the sum of sugar and pure alcohol is over 14% (example 7 % sugar and 7% pure alcohol ,or 4% sugar and 10% pure alcohol , or 14% sugar and 0% alcohol).If the mixture will have less than 14% the mixture will became hard ice and will damage mixer motor of the machine. If commercial mixes are used for slurries, sorbets, yoghurt or milk-based drinks, follow the manufacturer' s instructions.

Useful Information

- Do not pour hot mixture into the bowl(s)
- Do not put materials with solid particles , otherwise it will cause the machine blocked and damage the machine.
- To increase slurry production, pour with fresh mixture over the minimum level mark and should not over maximum level mark .Do not overfill .
- During operation, it is normal that the machine emits heat. Should this heat appear excessive, check that the condenser is not obstructed by dust, or that the machine is not positioned close to a heat source.
- For Indoor Use Only: This machine is designed to operate indoors, under normal ambient temperatures of 70°F to 75°F (21°C to 24°C). The machine has successfully performed in high ambient temperatures of 104°F (40°C) at reduced capacities. When the product is installed outside, prepare a shade to block direct sunlight, rain, wind, and dust for sanitary control and optimal performance.

Operation Procedure

Before use the machine ,please Clean and sterilize the product according to the instructions in this manual.

① Check handle assembly



② Check the drip tray assembly (The drip tube should be insert to the drip tray)

③ Fill up the liquid mixture over " min level " .

NOTE : When cooling cylinders are not covered by mixture , the slushie becomes hard and the machine makes a knocking noise.



④ Turn on power switch

⑤ Turn on independent control switch for each bowl. (Single bowl machine don' t have independent control switch)

Note: All the bowls should have material inside ,for 3 bowls machine should turn on all 3 bowls or at least turn on 2 bowls ,don' t only turn on one bowl .Otherwise machine may meet frozen problem and blocked.

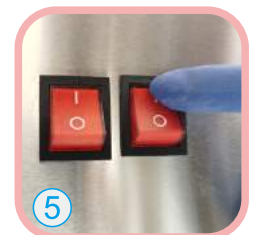

⑥ Make Slush : Press Function button to Slush Mode. Slush Mode light is ON .

Make Juice : Press Function button to Juice Mode . Juice light is ON A/B/C light turn on and Machine goes into 300s countdown, compressor will start cooling automatically after 300s countdown.





⑦ Waiting 60-90 minutes slush /juice can be ready . When the thickness of slush/juice reaches the optimal value, freezing automatically stops. So always keep the product turned on. The spiral keeps rotating.

Note: The slush forming time is affected by various factors such as ambient temperature, initial material temperature, sugar level (Brix level) and viscosity setting. Though the conditions are the same, the forming time may vary depending on the bowl.

At night can turn on machine to Juice/Night mode to keep mix fresh.

Temperature in celsius will display at screen during machine running .

 Means A bowl temperature 14°C(57.2°F)

 Means B bowl temperature -2°C(28.4°F)

JUICE/NIGHT mode, keep mixture temperature 3~7°C(37.4~44.6°F).During Juice/Night mode machine control the temperature automatically ,no need adjust temperature .

Note!

- To reduce the slush forming time and increase the productivity, it is recommended to use the refrigerated materials.
- To reduce the slush forming time and increase the productivity, when the remaining mixture level drops below half, fill the mixture in the bowl.
- Before restarting the unit, ensure that no blocks of ice have formed, if so remove them before switching on the unit

Cleaning and Sterilizing Procedure

Cleaning and sanitizing of the machine is recommended to be performed daily .This section is a guideline only and subject to the requirements of the local health authorities.

- ① Press  Function button exit from Slush/Juice mode to Wash mode.
- ② Drain the slushie out of the bowl with auger running. When machine is nearly empty pour warm water
- ③ Drain the liquid
- ④ Fill again the tank with 2 gallons (7 Liters) of water
- ⑤ Drain the water
- ⑥ Add sanitizer for beverage dispenser (follow the instructions of the producer of the sanitizer)
- ⑦ Drain
- ⑧ Fill with fresh water and drain the water again, now the machine is ready to be used or to be stored.



Disassembling

CAUTION! Before disassembly and cleaning, remove the power plug to block power supply.

- ① Remove the handle pin.
- ② Remove the draw valve and spring.
- ③ Lift the front of the bowl to unlock the latch.
- ④ Pull out the bowl to the front.
- ⑤ Remove the spiral blade by pulling out.
- ⑥ Remove the inner auger by pulling out.
- ⑦ Remove the bowl gasket.
- ⑧ Lift the drip tray and pull it out, and empty the remaining water.
- ⑨ Use the proper brushes to clean the disassembled parts using the washing detergent.

Prepare a sterilization solution, sanitize the bowl, gasket and all parts that come in contact with beverage. Rinse with clear water as recommend.

Place the sterilized parts on a clean and dry place for drying them

Caution! Never clean the parts in the dish washer.

Cleaning the condenser

As shown in the figure, open the cover of the condenser every 3 months.

1. Open the side panel.
2. Use a vacuum cleaner or hand cleaner to remove dust from the condenser.



Caution: The pin of the condenser is very sharp. Be careful while cleaning it.

Slush machine

Machine Assembling

① Lubricate the bowl gasket with food grade lubricant (vaseline)

② Install the bowl gasket to machine.
Caution: Be sure for the wide border of the gasket to face the wall.

③ Lubricate the hole of the inner auger.

④ Install the inner auger to the machine.

⑤ Lubricate the head part of the spiral.

NOTE: Please lubricate as picture ③ and ⑤, otherwise spiral may have squeak noise.

⑥ Install the spiral. Make sure spiral locked with inner auger well .

⑦ Install the bowl to machine , push the bowl fully into the fixing latch.

⑧ Lubricate the o-ring on the draw valve.

⑨ Install the draw valve with spring.

⑩ Install the handle.

⑪ Install drip tray



Rinse using fresh water to remove the remaining sterilization solution from the parts in contact with the beverage

Trouble-Shooting List

Failure	Cause	Solutions
Material leaking from outlet nozzle	Draw valve o-ring broken	Replace a new draw o-ring (Part 405)
Material leaking from bowl/tank	Bowl gasket broken or not install well	Replace a new bowl gasket(Part 444)
The spiral rotation is stopped or keep shaking (Noise is generated.)	Low sugar level in the material.(The spiral is frozen.)	Add enough sugar (sugar level 13% to 15%)
	Too low mix inside bowl	Add enough material to bowl, mix should over minimum mark
The spiral or inner auger make squeak noise	The spiral or inner auger not lubricated	Lubricate the spiral or inner auger (Page 8 ,photo ③ ⑤)
The spiral or inner auger not auger not works	Independent control switch not works	
	Ice blocked inside bowl	Turn off the power switch and melt the ice. the ice,then try again
	Motor broken	Replace a new motor
	Motor get protection itself	Wait 30 mins ,melt ice and operate again .
Slush too soft	Viscosity setting too low	Adjust viscosity level higher
	Too much sugar in material	Sugar level 13% to 15% is best
Slush too thick	Viscosity setting too high	Adjust viscosity level lower
Ice formed outside the bowl	Room temperature too low	Normal operation
	Material have alcohol inside	Normal operation
The slushie is not formed (Little cold , not slushie)	The material recipe not correct	Replace the material (sugar level: 13 to 15%)
	The sugar level is set to Weak	Connect the cord of the cap.
	Condenser too dirty	Cleaning the condenser every 3 months . (Page 7)
	Gas leaking	Check with refrigeration engineer
Independent control switch not works .	Independent control switch broken	Replace a new control switch
	Wire connection behind the independent control switch loose	Check the wire connection
Compressor not cooling	Wire connection loose	Check compressor wire connection
	Gas leaking	Check with refrigeration engineer
	Main fan not works or broken	Check the main fan or replace a new fan
	Compressor broken	Replace a new compressor
Power is not supplied	Power is not supplied from the outlet.	Check the outlet connection status.
	The power switch is turned off.	Turn on the power switch
	Power switch broken	Replace a new power switch

SPARE PARTS LIST

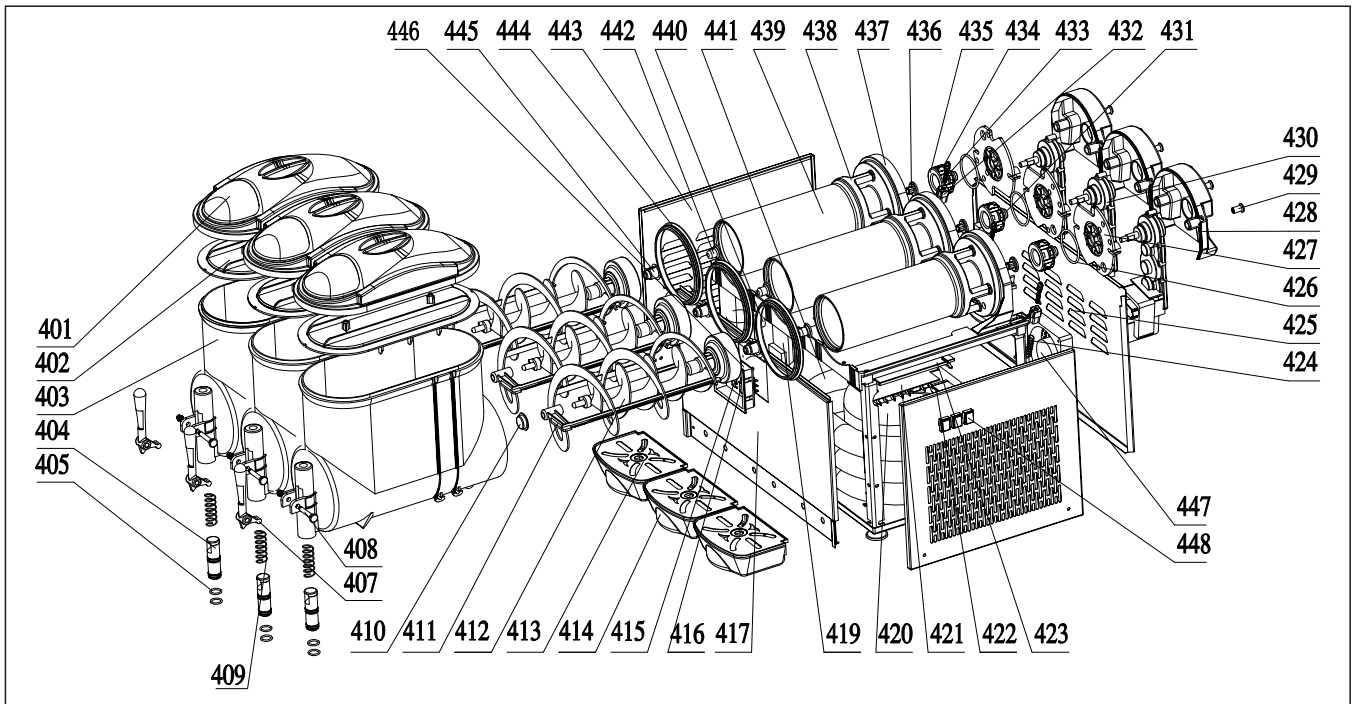

Part	Description	Part	Description
401	Top Cover	426	Sealing-Middle Plate
402	Lining-Top Cover	427	Middle Plate
403	Bowl/Tank	428	Back Cover-Reducer
404	Draw Valve	429	Nuts-Back Cover
405	Seal-Draw Valve	430	Gear Motor
407	Handle	431	Lining-middle plate
408	Handle pin	432	Cover-adjustable bolt
409	Spring-Small	433	Adjustable Bolt
410	Fixed Ring	434	Drive Supportr -Cover
411	Outer Spiral	435	Drive support
412	Inside Auger	436	Hexagonal Lining
413	Cover-Drip Pan/tray	437	Back Base support
414	Drip Pan/Tray	438	Evaporator support
415	Display Board	439	Assembly Evaporator
416	ON/OFF Button	440	Fan
417	Front Panel	441	Condenser
419	Accessory-Compressor	442	Front Lining
420	Compressor	443	Left Panel
421	Control/Main Board	444	Bowl gasket
422	Electromagnetic Valve	445	Back Lining-Inside Auger
423	Chute-Control Board	446	Switch box
424	Regulating Spring	447	Axial Flow Fan
425	Back Panel	448	Separate Control Switch