

ASSEMBLY INSTRUCTIONS

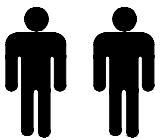

2 PERS.

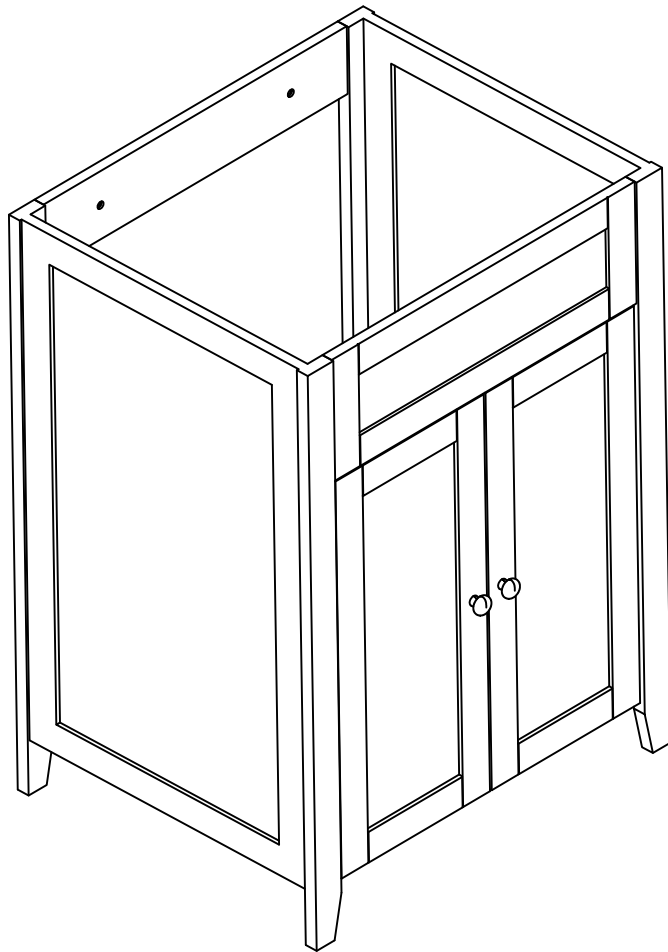

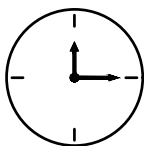

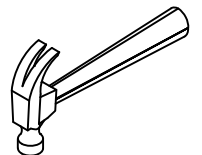
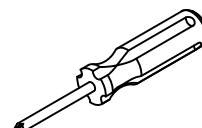
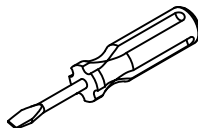
40 MIN



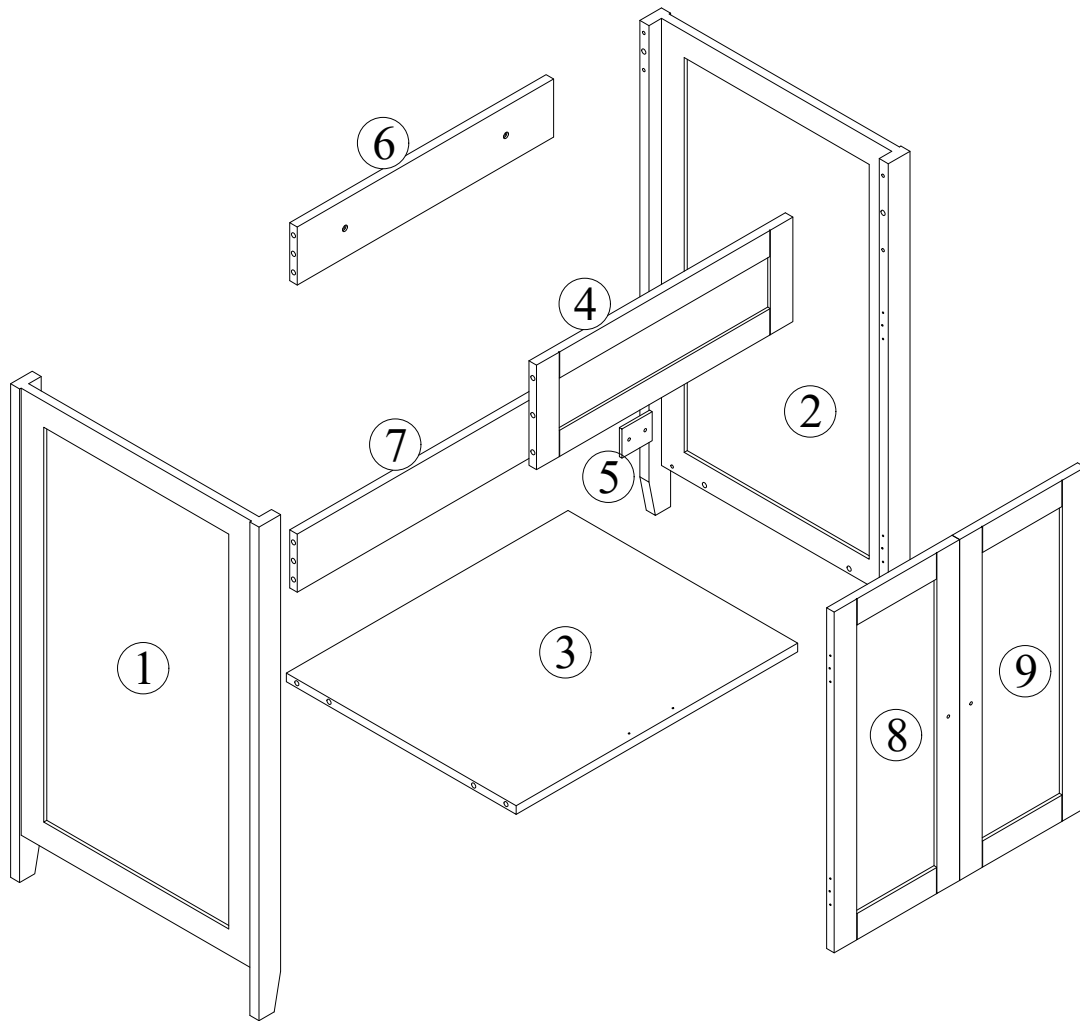

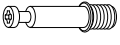
Components





| | |
|---|------|
| A | x 16 |
|  | |
| Φ6X35mm | |

| | |
|---|------|
| B | x 16 |
|  | |
| Φ15X9mm | |

| | |
|---|------|
| C | x 10 |
|  | |
| Φ8X30mm | |

| | |
|---|-----|
| D | x 2 |
|  | |
| Φ3X12mm | |

| | |
|---|------|
| E | x 26 |
|  | |
| Φ3X14mm | |

| | |
|---|-----|
| F | x 2 |
|  | |
| Φ4X14mm | |

| | |
|---|-----|
| G | x 2 |
|  | |
| M4X16mm | |

| | |
|---|-----|
| H | x 2 |
|  | |
| Φ6X35mm | |

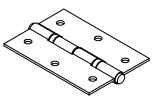
| | |
|---|-----|
| I | x 4 |
|  | |

| | |
|---|-----|
| J | x 1 |
|  | |

| | |
|---|-----|
| K | x 2 |
|  | |

| | |
|---|-----|
| L | x 2 |
|  | |

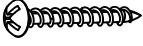
| | |
|---|-----|
| M | x 2 |
|  | |
| Φ4X45mm | |

| | |
|--|--|
| | |
|--|--|

| | |
|--|--|
| | |
|--|--|

1

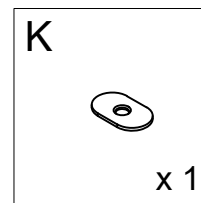
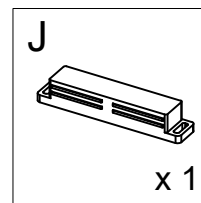
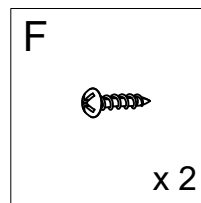
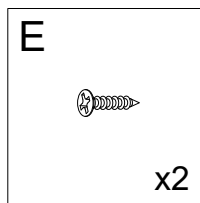
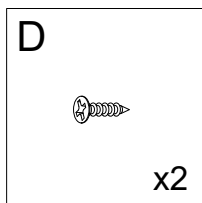
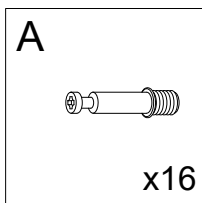
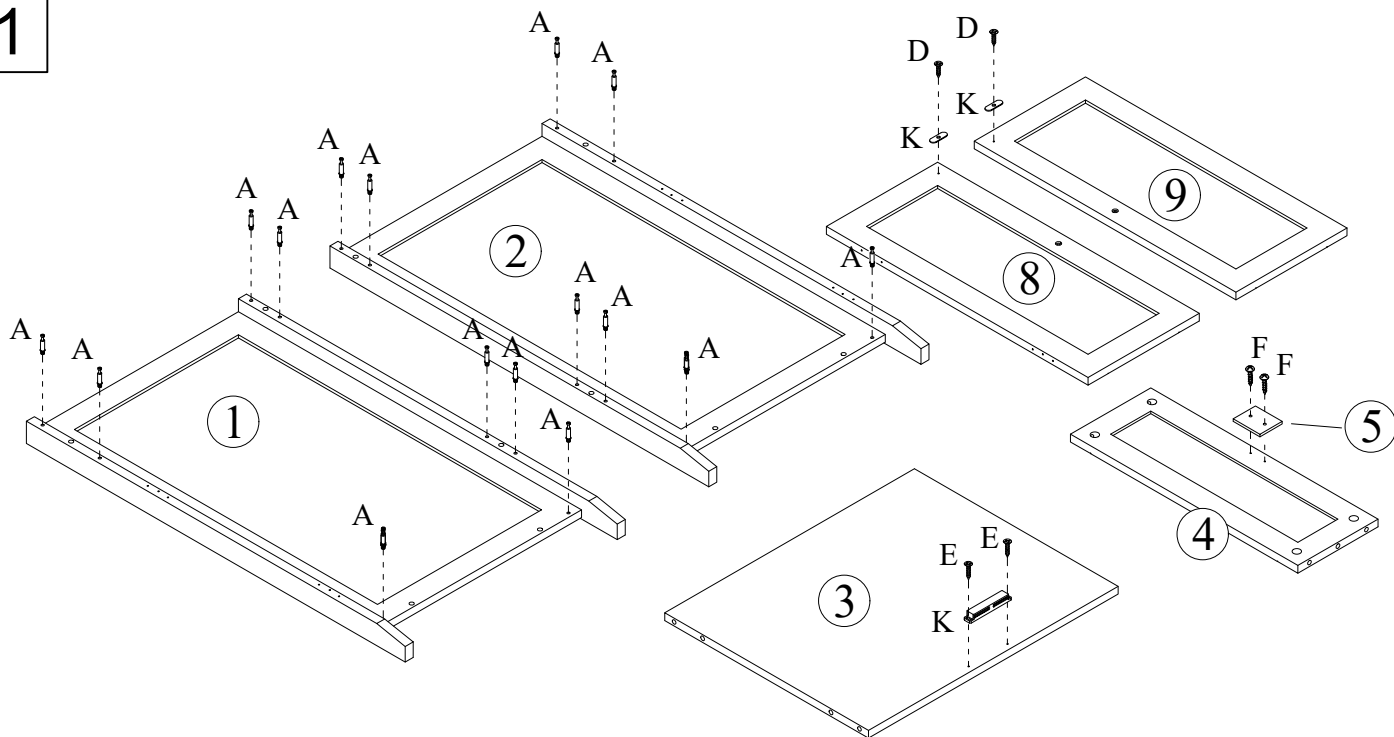

2

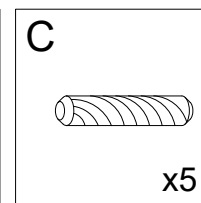
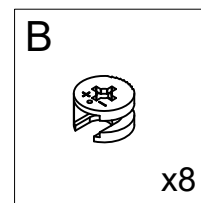
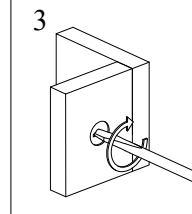
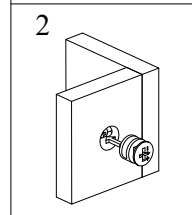
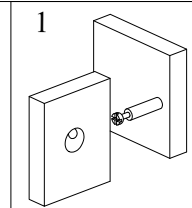
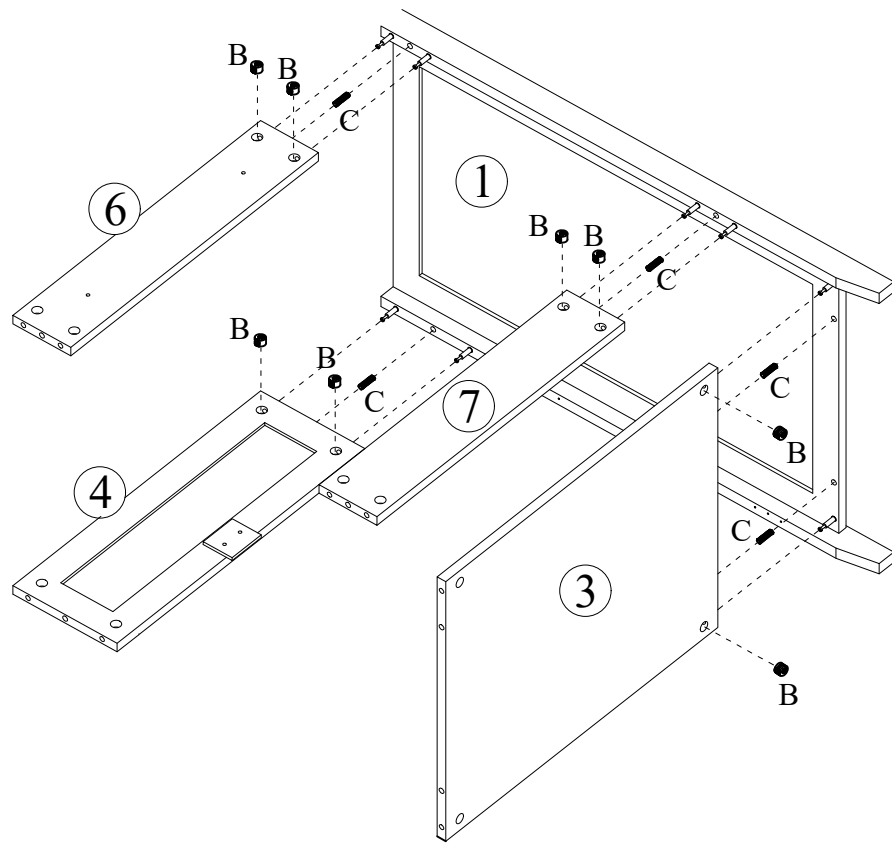

3

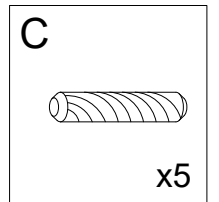
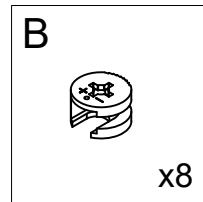
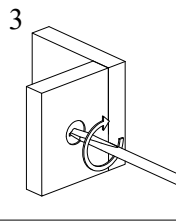
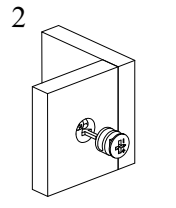
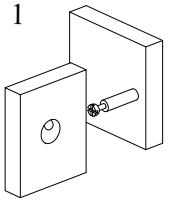
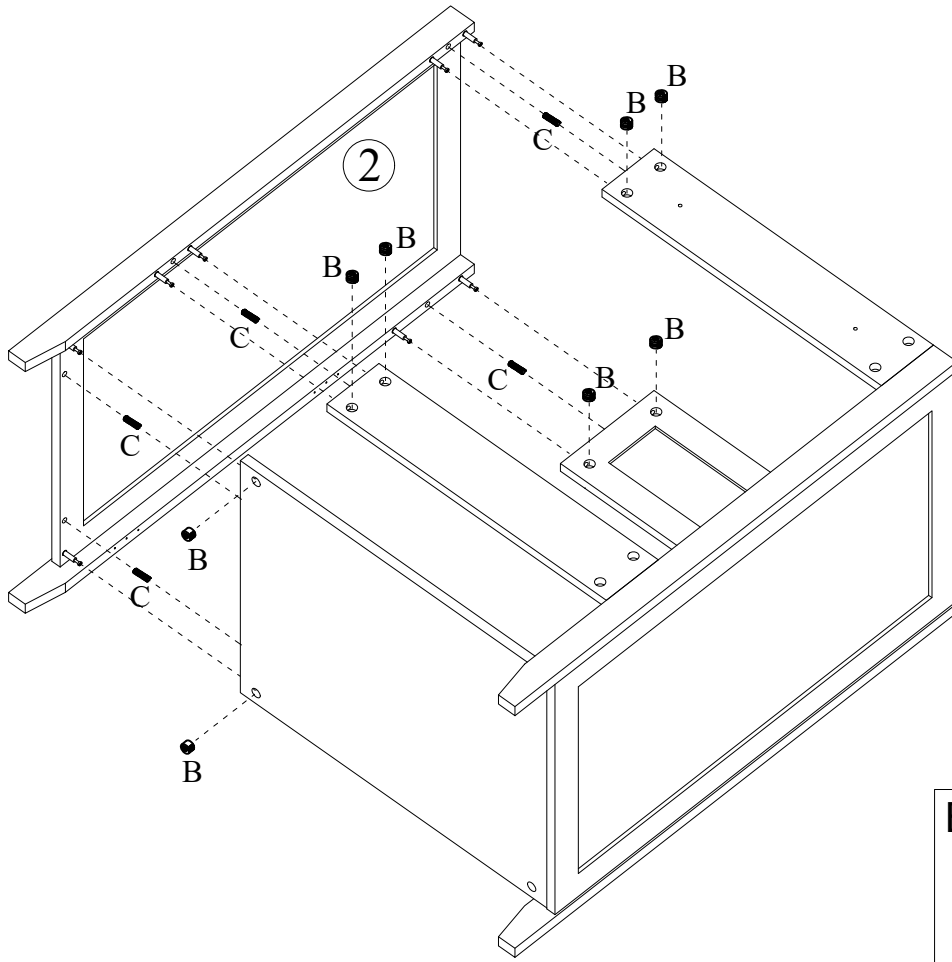

4

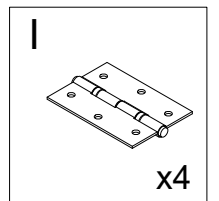
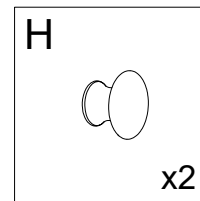
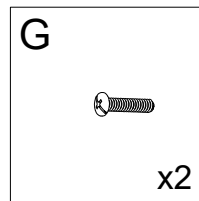
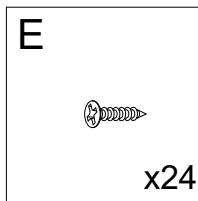
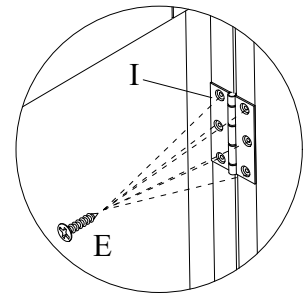
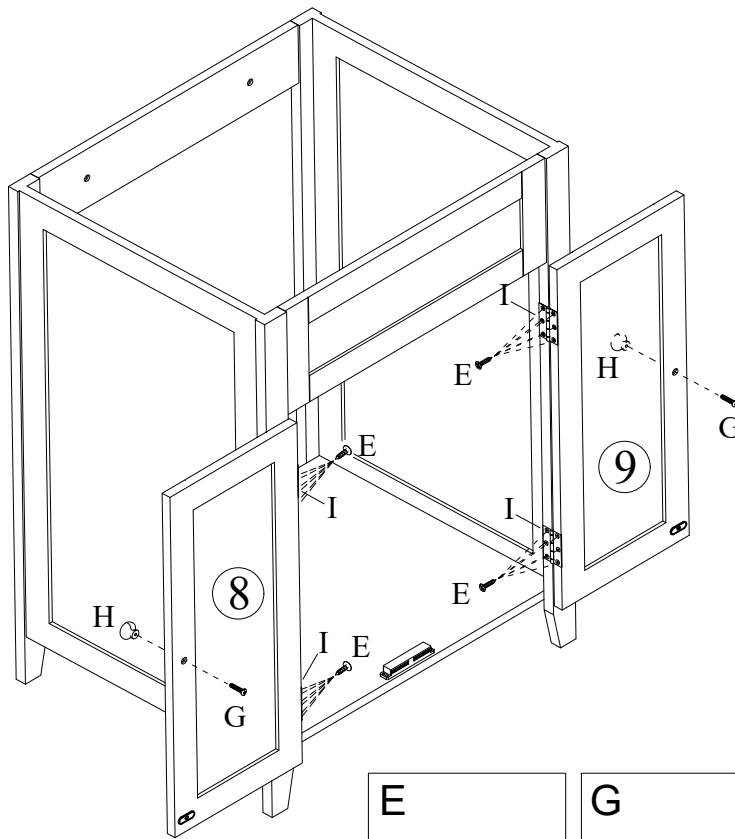

5

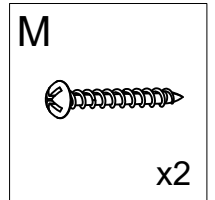
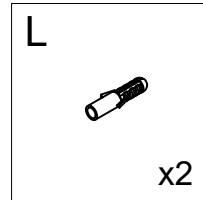
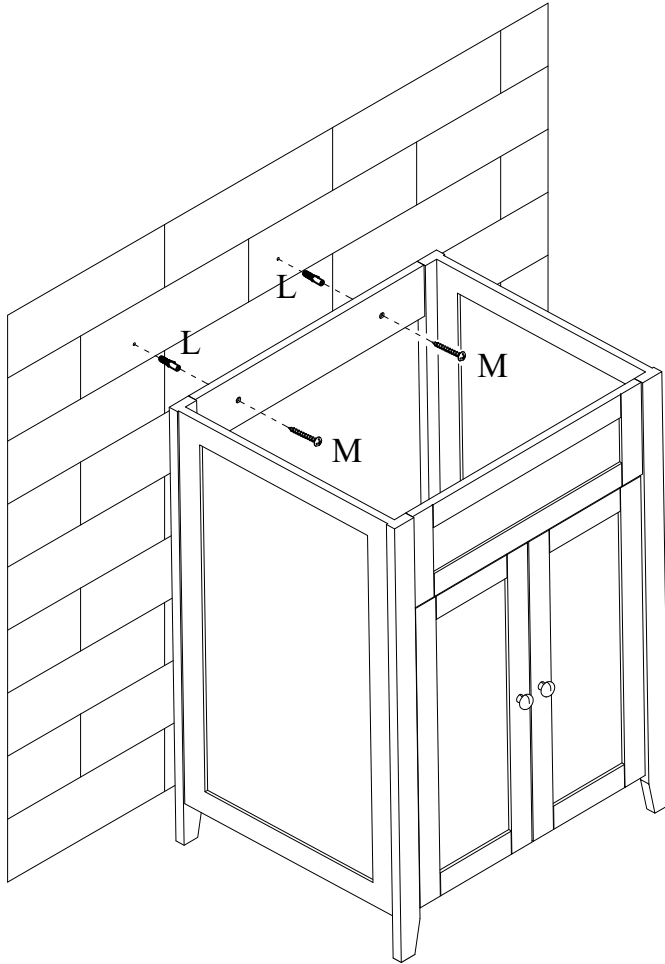

6

