

ROVSUN

Window Air Conditioner

USER MANUAL

8000Btu, 10000Btu, 12000Btu

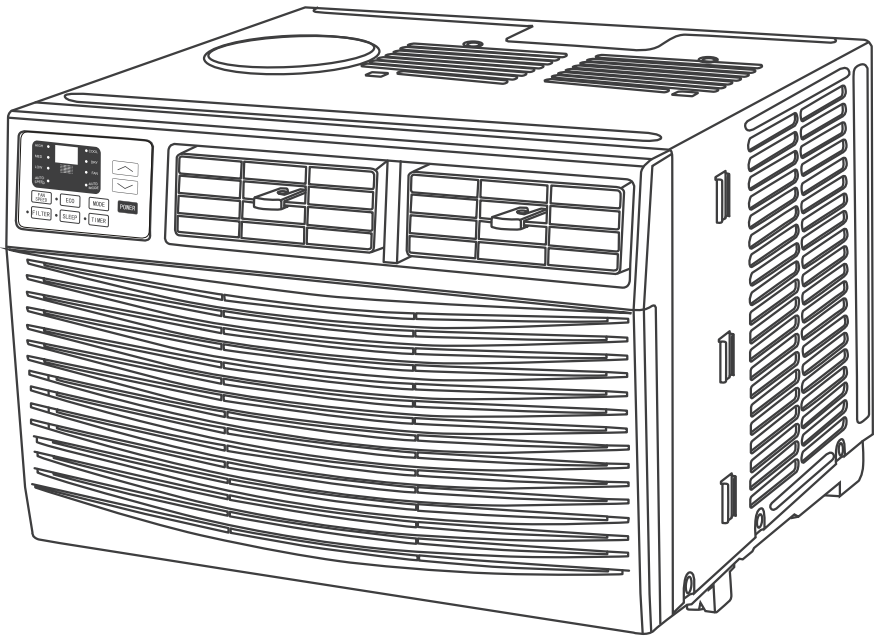

Thank you for purchasing this Window Air Conditioner. Before operating this unit, please read these instructions completely and keep the manual ready for further reference.

Made in China

INTRODUCTION

IMPORTANT SAFETY INSTRUCTION	1
INTRODUCTION TO REFRIGERANTS R32(Only for R32 Model).....	2
ELECTRICAL REQUIREMENTS	3
PACKING LIST	4
INSTALLATION&ASSEMBLY INSTRUCTIONS	6
THROUGH-THE-WALL INSTALLATION INSTRUCTIONS.....	11
INSTALLATION & ASSEMBLY INSTRUCTIONS.....	12
USING YOUR AIR CONDITIONER	13
OPERATING YOUR AIR CONDITIONER	15
CARE AND CLEANING	16
TROUBLESHOOTING	17

IMPORTANT SAFETY INSTRUCTIONS

Before installing and using your air conditioner, please read this owner's manual carefully. Store this manual in a safe place for future reference. Your safety and the safety of others is very important to us. Please pay attention to all safety messages outlined in this owner's manual.

WARNING: To reduce the risk of fire, electrical shock or injury when using your air conditioner, follow the following basic precautions:

- Plug into a grounded 3 prong outlet.
- Do not remove the ground prong.
- Do not use a plug adapter.
- Do not use an extension cord.
- Unplug the air conditioner before servicing
- Use two or more people to move and install the air conditioner



This is a safety alert symbol.

This symbol alerts you to potential hazards that can harm you or others or even cause death.

All safety messages will directly follow the safety alert symbol and/or the words "DANGER" or "WARNING".

▲ DANGER

▲ WARNING

Failure to immediately follow these instructions may cause serious injury or even death.

All Safety messages alert you of potential hazards, how to reduce the chance of injury, and what can happen if instructions are not followed correctly.

INTRODUCTION TO REFRIGERANTS R32(Only for R32 Model)

The refrigerants used for air conditioners are environmentally friendly hydrocarbons R32. This kind of erant is combustible and odorless. Moreover, it can burn and explode under certain condition. However, there will be no risk of burning and explosion if you comply with the following table to install your air conditioner in a room with an appropriate area and use it correctly.

Compared with ordinary refrigerants, Refrigerant R32 is environmentally friendly and do not destroy the ozone sphere and that its value of greenhouse effect is also very low.

Room area requests for air conditioner with Refrigerant R32

Refrigerant	Capacity(Btu)	Room Area
R32	≤9K	Above 4m ²
	≤12K	Above 4m ²
	≤18K	Above 15m ²
	≤24K	Above 25m ²

Warnings

- Please read the manual before installation, using, maintenance.
- Do not use means to accelerate the defrosting process or to clean, other than those recommended by the manufacturer.
- Do not pierce or burn the appliance.
- The appliance shall be stored in a room without continuously operating sources (for example: open flames, an operating ignition gas appliance or an operating electric heater.)
- Please contact the nearest after-sale service center when maintenance is necessary. At the time of maintenance, the maintenance personnel must strictly comply with the Operation Manual provided by the corresponding manufacturer and any non-professional is prohibited to maintain the air conditioner.
- The handling, installation, storage, servicing and disposal must comply with the provisions of gas-related national laws and regulations, and also national wiring regulation.
- It is necessary to clear away the refrigerant in the system when maintaining or scrapping an air conditioner. Be aware that refrigerants may not contain an odour.

This appliance is not intended for use by persons (including children) with reduced physical, sensory or mental capabilities, or supervision or instruction concerning use of the appliance by a person responsible for their safety.

Children should be supervised to ensure that they do not play with the appliance.

Unit operation limits: Outdoor side 61~110°F, 80%RH; indoor side 61~90°F, 80%RH.



ELECTRICAL REQUIREMENTS

⚠ WARNING





Electrical Shock Hazard

Plug into a grounded 3 prong outlet.
Do not remove the ground prong.
Do not use an adapter
Do not use an extension cord.
Failure to follow these instructions can result in death, fire, or electrical shock

The electrical ratings for your air conditioner are listed on the model and serial number label located on the front left side of the unit (when facing the front).

Specific electrical requirements are listed in the chart below. Follow the requirements below for the type of plug on the power supply cord.

Wiring Requirements	Power Supply Cord	
<ul style="list-style-type: none"> 115 volt (103 min.—127 max) (6K cooling) 10A time-delay fuse or circuit breaker (8K-12K cooling & 8K heating) 15A time-delay fuse or circuit breaker (12K heating) 20A time-delay fuse or circuit breaker Use on single outlet circuit only 	6K/8K/10K/12K Cooling 8K Heating	12K Heating
		

Recommended Ground Method

For your personal safety, this air conditioner must be grounded. This air conditioner is equipped with a 3 prong power supply cord with a grounded plug. To minimize the possibility of electrical shock, the cord must be plugged into a 3 prong outlet and grounded in accordance with all local codes and ordinances. If a 3 prong outlet is not available, it is the customer's responsibility to have a properly grounded 3 prong outlet installed by a qualified electrician.

It is the customer's responsibility:

- To contact a qualified electrician
- To assure that the electrical installation is adequate and in conformance with the National Electrical Code, ANSI/NFPA 70 - latest edition, and all local codes and ordinances.

Copies of the standards listed may be obtained from:

National Fire Protection Association
One Batterymarch Park
Quincy, Massachusetts 02269

LCDI Power Cord and Plug

This air conditioner is equipped with an LCDI (Leakage Current Detection and Interruption) power cord that is required by UL. This power supply cord contains state-of-the-art electronics that sense leakage current. If the cord is damaged and leakage occurs, power will be disconnected from the unit.

The test and reset buttons on the LCDI Plug are used to check if the plug is functioning properly. To test the plug:

1. Plug power cord into a grounded 3 prong outlet
2. Press RESET (on some units a green light will turn on).
3. Press the TEST Button, the circuit should trip and cut all power to the air conditioner (on some units a green light may turn off).
4. Press the RESET button for use. You will hear a click and the A/C is not ready for use.













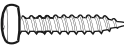

NOTES:

- The RESET button must be engaged for proper use.
- The power supply cord must be replaced if it fails to trip when the TEST button is pressed and the unit fails to reset.
- Do not use the power supply cord as an ON/OFF switch. The power supply cord is designed as a protection device.
- A damaged power supply cord must be replaced with a new power supply cord.
- The power supply cord contains new user serviceable parts. Opening the tamper-resistant case voids all warranty and performance claims.

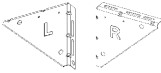

NOTE: Your units power cord and plug may differ from the one shown.

PACKING LIST

IMAGE	PART	QUANTITY
	Window Air Conditioner	1
	Remote Control	1
	Top Mounting Rail (With sponge)	1
	Filler Panels (With "Left" & "Right" remark on the front face)	2
	Sash Lock(Two holes)	1
	Window Sash Seal (Sponge)	1
	3/8" Short Screws	5
	1/2" Length Screws	4
	3/4" Long Screws	3
	5/8" Big Flat Head Bolt and Locknut	2
	Sill Angel Bracket	2
	1/2" Small Flat Head Bolt and Locknut	4
	Chassis Lock	1
	Foam Top Window Gasket (Thin sponge for back-up using)	1
	Insulation strip(Sponge) (Only for E-star model)	2
	Support Bracket(with R and L remark)	2
	Battery	2

DISCLAIMER

ALL INFORMATION AND THE TECHNICAL SPECIFICATIONS PRESENTED IN THIS USER'S MANUAL ARE THE PRESENTATION OF THE MANUFACTURE. PLEASE READ AND FOLLOW THESE INSTRUCTIONS CAREFULLY.

INSTALLATION & ASSEMBLY INSTRUCTIONS

Window preparation

1. This air conditioner is designed to be installed in a standard double-hung window with a window width.
2. The air conditioner can be installed without the accordion panels fit in a narrow window opening.
3. The lower sash (the lower part of the window that moves up and down) must allow for vertical clearance when open.
4. All supporting parts must be secured to firm wood, masonry, or metal.
5. The electrical outlet must be within reach of the power cord.

For 6K/8K-Cooling

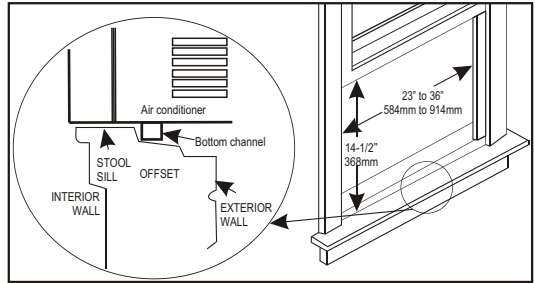

For 10K/12K-Cooling, 8K/12K-Heating

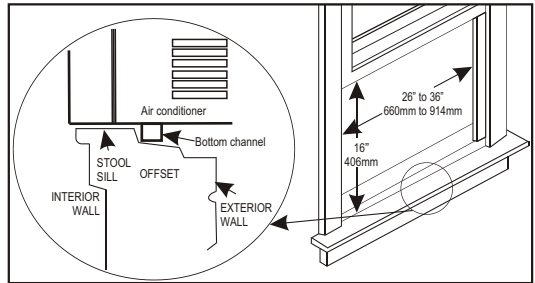

NOTE: Save the product packaging and installation instructions for future reference. Store the air conditioner in the product box when not in use for an extended period of time.

How to Install

NOTE: This is necessary for proper condensed water utilization and drainage. If you are not using the Side Panels for any reason, this pitch to the rear must be maintained!

Remove the air conditioner from the box and place on a hard flat surface, as floor, a bench or a table. There is a Left and Right Window Filler Panel - be sure to use the proper panel for each side. When installed the flange for securing the panel in place to the window sill will be facing into the room.

TOOLS NEEDED:

- Phillips Screw Driver
- Drill (If pilot holes are needed)

CAUTION

When handling unit, be careful to avoid cuts from sharp metal edges and aluminum fins on front and rear coils.

Be sure that, there will be a 3 tilt angle downward to the unit back side, after finish the unit installation.

INSTALLATION & ASSEMBLY INSTRUCTIONS - WINDOW MOUNTING

REMOVE FRONT PANEL AND CHASSIS

1. Pull down the front panel and remove the filter.
2. Lift the front panel upwards to remove and place to the side.

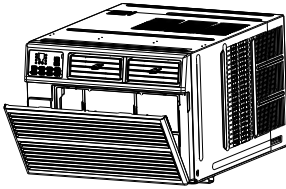

5. Remove the control panel screw and WI-Fi module screw (if available) from the front panel.

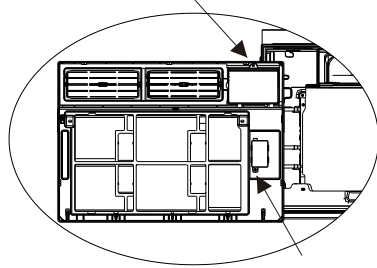

3. Locate the two faceplate screws and remove. These screws will need to be re-installed prior to mounting the air conditioner.

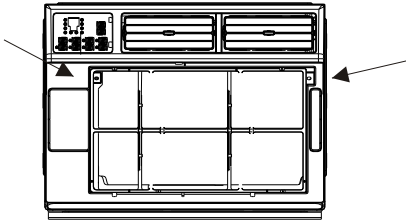

6. Remove the screws from the cabinet.

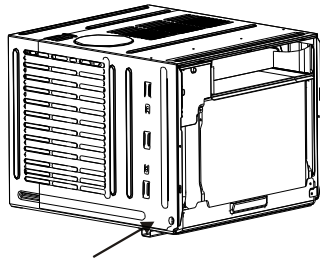

4. After removing the screws, gently pull away the faceplate from the air conditioner cabinet.

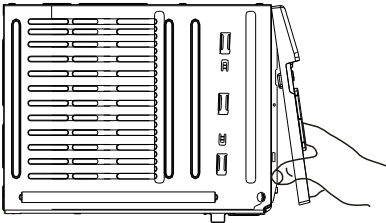

7. Hold the cabinet while pulling on the base handle to carefully remove the unit. Do not pull or lift near the top of the unit.

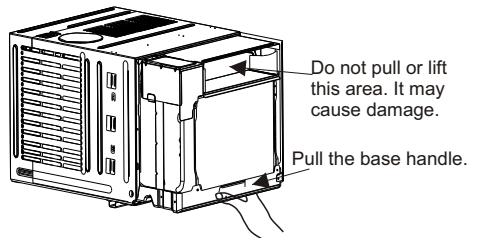



INSTALLATION & ASSEMBLY INSTRUCTIONS - WINDOW MOUNTING

Top Rail Assembly

The top rail must be assembled prior to installing the air conditioner in the window.

Tools Needed: Phillips Screw Driver

Top Rail Hardware		QTY
	3/8" Screw	4
	Top Rail	1

Attaching the Top Rail to the Air Conditioner

1. Place the cabinet on a hard flat surface.
2. Remove top rail from the top form of the packaging material as shown in FIG. A.
3. Align the hole in the top rail with those on the top of the unit as shown in FIG. B.
4. Secure the top rail to the unit with the 3/8" screws as shown in FIG. C.

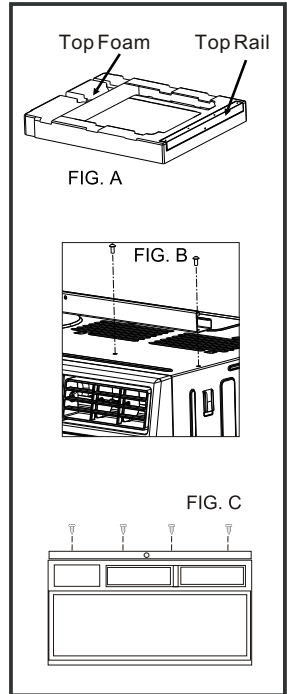

NOTE: For safety reasons, all 4 screws must be used to attach the top rail.

CAUTION

When handling the unit, be careful to avoid cuts from the sharp metal edges and aluminum fins on the front and rear coils.

Be sure that, there will be a 3 tilt angle downward to the unit back side, after finish the unit installation.

INSTALLATION & ASSEMBLY INSTRUCTIONS - WINDOW MOUNTING

Accordion Panel and cabinet Assembly

1. Hold the Accordion Panel in one hand and gently pull the center to free the open end.

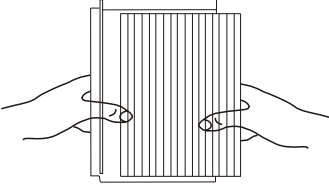

2. Slide the free end of the panel into the cabinet as shown. Be sure to leave enough space to slip the top and bottom of the frame into the rails on the cabinet.

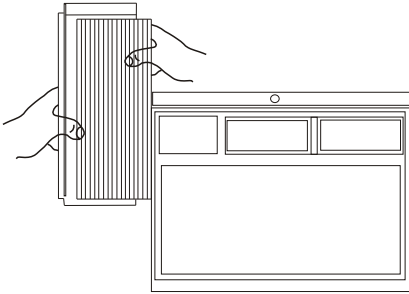

3. Once the panel has been installed on the side of the cabinet, make sure it sits securely inside the frame channel by making slight adjustments. Slide the top and bottom ends of the frame into the top and bottom rails of the cabinet. Slide the panel all the way for both sides.

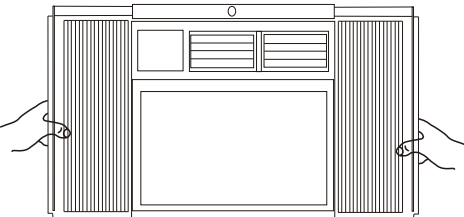

4. Use two or more people, place the air conditioner into the window opening so the bottom of the air conditioner frame is against the window sill. Tilt the back of the unit slightly downward to allow accumulated rain water to drain out.

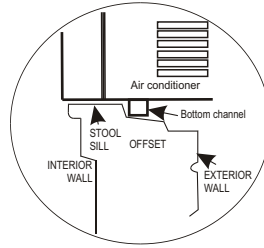

5. Fasten cabinet bottom to window sill using two 1/2" screws. Pre-drill holes if needed.

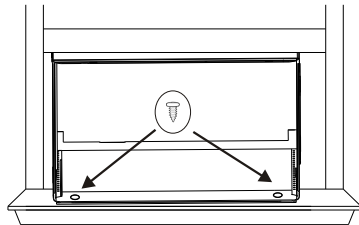

INSTALLATION & ASSEMBLY INSTRUCTIONS - WINDOW MOUNTING

Install Support Brackets

1. Hold each support bracket flush against the outside of the window sill. Tighten each bracket to the bottom of the cabinet as shown. Mark the brackets at top lever of the window sill and then remove.

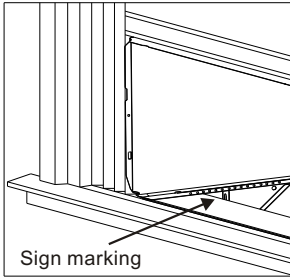

2. Assemble the sill angle brackets to the support brackets at the marked position with long bolt and locknut as shown. Hand tighten, but not all the way for any changes that may need to be made later during installation.

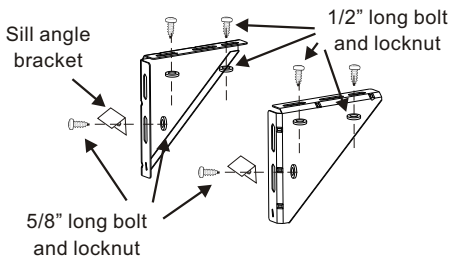

3. Install the support brackets (with sill angle brackets) to the bottom of the cabinet as shown.

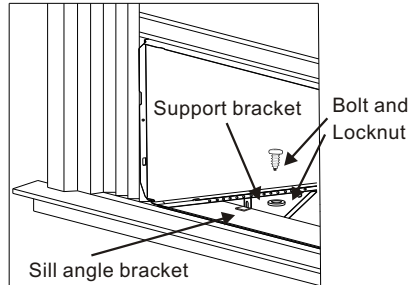

4. Tighten all the bolts with locknuts securely.

Installing the Chassis into the Cabinet

1. Team lift (two people or more) the air conditioner chassis and carefully slide it into the cabinet. Let the front of the air conditioner hang out approximately 6".
2. CAUTION: DO NOT PUSH ON THE CONTROLS OR FINNED COILS.
3. Be sure the chassis is firmly seated in the back of the cabinet.
4. Insert all screws removed during window installation and fasten, then reattach the front face plate, front panel, and the air filter.
5. If the wall is too near to effect driving the cabinet screw back, you can assemble the chassis lock at the right bottom corner of chassis with 3/8" screw as shown, before assemble the front panel.

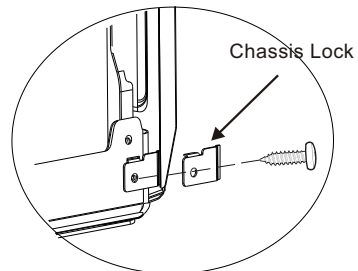

5. Extend the side accordion panels out against the window frame as shown.

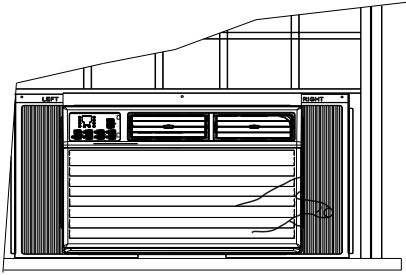

7. To secure lower sash in place, attach right angle sash lock with 3/4" screws as shown.

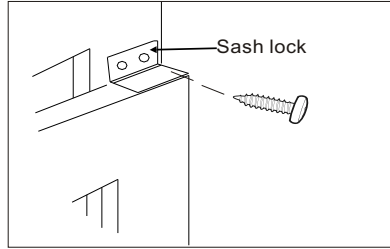

6. Drive 1/2" locking screws through frame holes, and drive one 3/4" screw through top rail into window sash as shown.

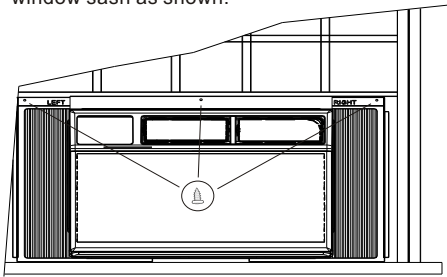

8. Cut foam seal and insert in the space between the upper and lower sashes as shown.

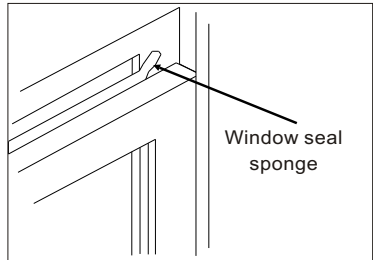

Storm Window Requirements

A storm window frame will not allow the air conditioner to tilt properly which in turn will keep it from draining properly. To adjust for this, attach a board or piece of wood to the sill. The board or wood piece should have a depth of at least 1/2". Make sure the board or piece of wood is approximately 1/2" higher than the storm window frame. This will allow the air conditioner to tilt enough for proper drainage.

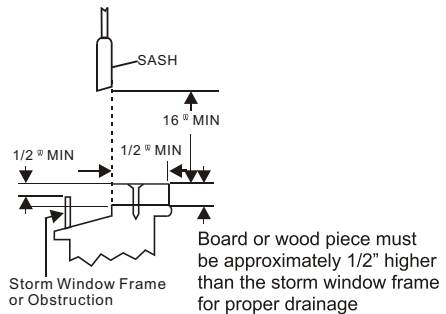
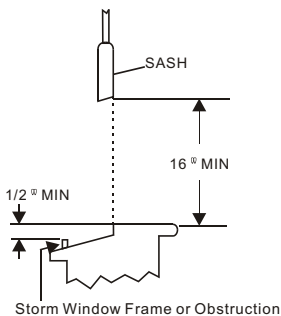

THROUGH-THE-WALL INSTALLATION INSTRUCTIONS - OPTIONAL

The case may be installed through-the-wall as optional. Read completely, then follow step-by-step.
 NOTE: Obtain all materials locally for mounting the air conditioner through-the-wall.

IMPORTANT

Building a wooden frame is required when install the case through-the-wall. The opening and dimension of wooden frame is required as below.

Frame Max. Thickness	8 9/10" (225 mm)
Inside Frame Width	20" (508 mm)
Inside Frame Height	15-1/5"(385 mm)

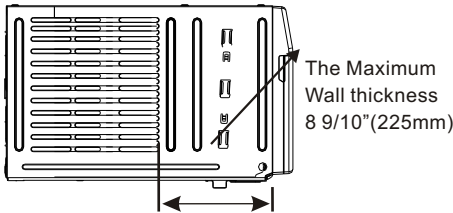
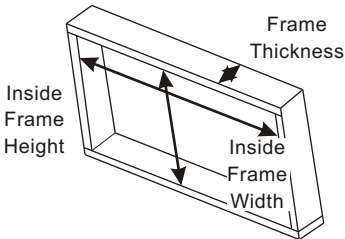

Through-the-wall installation is not appropriate, if any of the side or top louvers of case is obstructed by the wall.

All side and top louvers in the case must project on the outdoor side of the wall.

The room side of the case must project into the room far enough to maximize the balance of the unit.

The case must be installed level from side to side and with a slight tilt from front to rear. Use a level, no more than a 1/2 bubble will be correct slant to the outside.

Lintel angle is required to support bricks or blocks above opening.

Flashing is required and should extend the length of the opening to ensure no inside cavity leakage occurs.

NOTE: The allowed maximum wall thickness is less than 8 9/10". Otherwise, the wall will block the air inlet of outdoor side, it will effect the normally operation of unit.

1. Build a wooden frame into the wall opening and make sure fasten securely, which is suitable to the WALL OPENING REQUIREMENT.
2. Remove the air conditioner from the carton box and take off the chassis as window mounting installation.
3. Place the cabinet into the wooden frame, and lock the cabinet by the top rail hole and bottom chassis hole with 1" long wood screws as shown, from inside to outside.

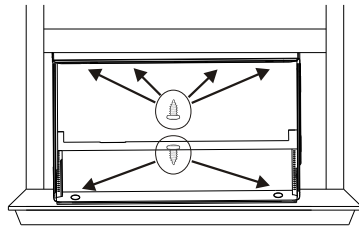

4. Assemble the two Support Bracket with Sill Angle Bracket to the cabinet against to the wooden frame as window mounting installation instructions.

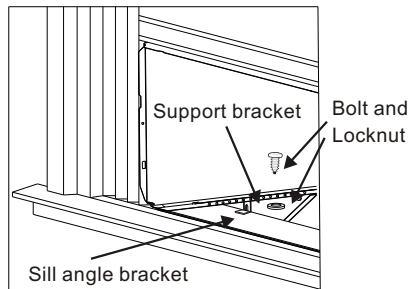

5. Assemble the chassis into the cabinet and fasten or lock it, as window mounting installation instructions.

INSTALLATION & ASSEMBLY INSTRUCTIONS

Important Considerations

- Before installing the appliance, you must read the manual carefully to get the safety information and notes.
- Unit refrigerant charge amount: refer to unit name plate marking.
- A leak test must be done after the installation is completed.
- It is a must to do the safety inspection before maintaining or repairing an air conditioner using combustible refrigerant in order to ensure that the fire risk is reduced to minimum.
- It is necessary to operate the machine under a controlled procedure in order to ensure that any risk arising from the combustible gas or vapor during the operation is reduced to minimum.



Introduction to Refrigerants R32(Only for R32 Model)

1. Site Safety



Open Flames Prohibited



Ventilation Necessary

2. Operation Safety

Open Flames Prohibited



Mind Static Electricity



Must Wear Protective Clothing and anti-static gloves



Don't use mobile phone

3. Installation Safety

- Refrigerant Leak Detector
- Appropriate Installation Location



The left picture is the schematic diagram of a refrigerant leak detector.

Please note that:

1. The installation site should be in a well-ventilated condition.
2. The sites for installing and maintaining an air conditioner using Refrigerant R32 should be free from open fire or welding, smoking, drying oven or any other heat source higher than 548°C which easily produces open fire.
3. When installing an air conditioner, it is necessary to take appropriate anti-static measures such as wear anti-static clothing and/or gloves.
4. It is necessary to choose the site convenient for installation or maintenance wherein the air inlets and outlets of the indoor and outdoor units should be not surrounded by obstacles or close to any heat source or combustible and/or explosive environment.
5. If the indoor unit suffers refrigerant leak during the installation, all the personnel should go out till the refrigerant leaks completely for 15 minutes. If the product is damaged, it is a must to carry such damaged product back to the maintenance station and it is prohibited to weld the refrigerant pipe or conduct other operations on the user's site.
6. It is necessary to choose the place where the inlet and outlet air of the indoor unit is even.
7. It is necessary to avoid the places where there are other electrical products, power switch plugs and sockets, kitchen cabinet, bed, sofa and other valuables right under the lines on two sides of the indoor unit, and also prevent mechanical damage from occurring.

USING YOUR AIR CONDITIONER

Electronic Control Panel & Remote Control

NOTE: This display always shows the room temperature in Fan Mode except when setting the Timer.

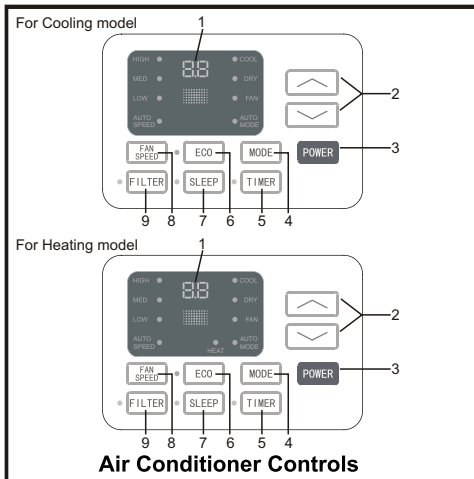

Air Conditioner Controls

Normal Operating Sounds

- You may hear a pinging noise caused by water hitting the condenser on rainy days, or when the humidity is high. This design feature helps remove moisture and improve efficiency.
 - You may hear the thermostat click when the compressor cycles on and off.
 - Water will collect in the base pan during rain or days of high humidity. The water may overflow and drip from the outside part of the unit.
 - The fan may run even when the compressor is not on.
- Digital Display:** Without timer setting, the set temperature will be displayed. Time will be displayed under the timer setting.
 - And Button:** Use these buttons on the control panel and remote to increase or decrease the Set Temperature or Timer. Temperature range: 61°F~88°F or 16°C~31°C.
 - Power Button:** Turn the air conditioner on and off.
 - Mode Button:** Press the mode button to cycle through the various modes: Cool, Dry, Fan and Auto, or Heat.

Cool Mode: The cooling function allows the air conditioner to cool the room and at the same time reduces air humidity. Press the MODE button to activate the cooling function. To optimize the function of the air conditioner, adjust the temperature and the speed by pressing the button indicated.

Dry Mode: This function reduces the humidity of the air to make the room more comfortable. Press MODE button to set the DRY mode. An automatic function of alternating cooling cycles and air fan is activated.

Fan Mode: The conditioner works in only ventilation. Press MODE button to set the FAN mode. With pressing the FAN SPEED button the speed changes in the following sequence: Hi, Med and Lo in FAN mode.

Auto Mode: In AUTO mode the unit automatically chooses the fan speed and the mode of operation (COOL, HEAT, DRY or FAN). In this mode the temperature are set automatically according to the room temperature (tested by the temperature sensor which is incorporated in the indoor unit.)

Heat Mode: The heating function allows the air conditioner to heat the room. Press the MODE button to activate the heating function. To optimize the function of the air conditioner, adjust the temperature and the speed by pressing the button indicated.

- Timer Button:** Use these buttons on the control panel and remote to set the Timer.

Timer Off: The timed stop is programmed by pressing TIMER button. Set the rest time by pressing the button “^” or “v” until the rest time displayed is to your liking then press the TIMER button again.

Timer On: When the unit is off, press TIMER button at the first time, set the temperature with pressing the button “^” or “v”. Press TIMER button at the second time, set the rest time with pressing the button “^” or “v”. Press TIMER button at the third time, confirm the setting, then the rest time to next automatical switching-on could be read on the display of the machine.

Note: It can be set to automatically turn off or on in 0.5-24 hours. Each press of the “^” “v” buttons will increase or decrease the timer. The Timer can be set in 0.5 hours increment below 10 hours and 1 hour increment for 10 hours or above. The SET light will turn on while setting.

To cancel the set function, press the TIMER button again.

USING YOUR AIR CONDITIONER

Electronic Control Panel & Remote Control

6. **ECO Button:** When the unit is in ECO mode, the light will turn on. In ECO mode, the unit will turn-off once the room is cooled to the user set temperature. The unit will turn back on when the room temperature rises above the user set temperature. Before the compressor starts, the fan motor will run for a while, then it will stop for awhile, It will repeat to provide a much more comfortable feeling and save energy.

7. **Sleep Button:** Press the SLEEP button, all of the display lights will turn off after a while, but the Sleep light is always on. In SLEEP mode, the air conditioner will automatically adjust the temperature and fan speed to make the room more comfortable during the night. The set temperature will automatically raise or decrease based on the room temperature and the duration of sleep.

8. **Fan Speed Button:** Press the FAN SPEED button to choose the fan speed options. You can choose Hi, Med, Lo or auto speed in COOL mode and choose Hi, Med, Lo in FAN mode.

9. **Filter Button:** When the Filter Check light is off, it isn't necessary to press the Filter Check button. When the Filter Check light is on, you can turn off the light by pressing the Filter Check button. After the fan motor works for 500 total hours, the Filter Check light will turn on to remind the user to clean the filter.

10. **Directional Louvers:** To direct the airflow, use the horizontal wheel to control the horizontal direction and the air deflector to control the vertical direction.



USING YOUR REMOTE CONTROL

REMOTE CONTROL

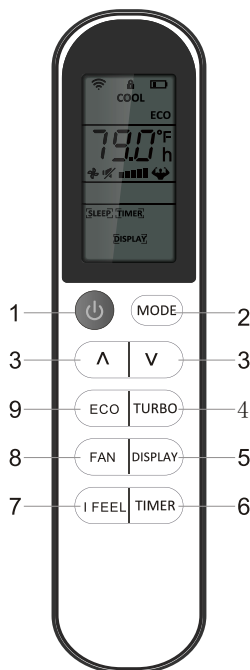

5. **DISPLAY:** By pressing the DISPLAY button, this will switch off/on all lights or LED display.
6. **TIMER:** Use the buttons on the control panel and remote to set the TIMER

Timer Off: When the unit is on, timer can be set by pressing the TIMER button. Set the run time by pressing the up " \wedge " or down " \vee " button until the desired run time is displayed, then press TIMER button again.











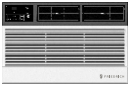

Timer On: When the unit is off, set the temperature by pressing the " \wedge " or " \vee " button. Then press the TIMER button to set the timer by pressing the " \wedge " or " \vee " button. Then Press TIMER button again to confirm. Both the TIMER and indicators will illuminate once set.

NOTE: It can be set to automatically turn off or on in 30 minutes to 24 hour intervals. Each press of the " \wedge " or " \vee " buttons will increase or decrease the timer. The TIMER can be set in 30 minute increments up to 10 hours, and 1 hour increments for 10 or hours and above. The SET light will turn on while setting. To cancel the set function, press the TIMER button again.

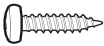
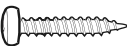
1. **POWER:** Turn the air conditioner on and off.
2. **MODE:** Press the button to select the mode of operation, AUTO, COOL, DRY, FAN and HEAT
Note: The HEAT mode is inactive for COOL ONLY models. Press and hold the MODE button for more than 5 seconds to delete or add the HEAT mode on remote.
3. **" \wedge " and " \vee ":** Use these buttons to increase or decrease the Set Temperature or Timer Temperature range is 61°F to 88°F (16°C-31°C)
4. **TURBO:** When the remote is ON, press the TURBO button to activate high fan mode.
NOTE For °F to °C change: After inserting the batteries in the off state, within 3 minutes, press and hold TURBO button for 5+ seconds to switch display from °F to °C.
7. **"I FEEL":** Press the "I FEEL" button to activate the follow me function, which enables the remote to take the temperature at its current location, and send this signal to the air conditioner to optimize the temperature around you and ensure comfort.
8. **FAN:** Press the "FAN" speed button to select the fan options. You can choose HI, MED, LO or AUTO in COOL MODE or HEAT MODE, and HI, MED, LO in FAN MODE.
9. **ECO:** When the unit is in ECO mode, the light will illuminate. In ECO mode, the unit will turn off once the room is cooled to the set temperature. The unit will turn back on when the room temperature rises above the set temperature. Before the compressor starts, the fan motor will keep cycling, to provide for a comfortable environment, while saving energy.

Battery Size: AAA - NOTE: Do not mix old and new batteries or different types of AAA batteries.

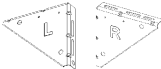
PACKING LIST

IMAGE	PART	QUANTITY
	Window Air Conditioner	1
	Remote Control	1
	Top Mounting Rail (With sponge)	1
	Filler Panels (With "Left" & "Right" remark on the front face)	2
	Sash Lock(Two holes)	1
	Window Sash Seal (Sponge)	1
	3/8" Short Screws	5
	1/2" Length Screws	4
	3/4" Long Screws	3
	5/8" Big Flat Head Bolt and Locknut	2
	Sill Angel Bracket	2
	1/2" Small Flat Head Bolt and Locknut	4
	Chassis Lock	1
	Foam Top Window Gasket (Thin sponge for back-up using)	1
	Insulation strip(Sponge) (Only for E-star model)	2
	Support Bracket(with R and L remark)	2
	Battery	2

TROUBLESHOOTING

PROBLEM	POSSIBLE CAUSES	SOLUTIONS
The Air Conditioner will not start	The air conditioner is unplugged	<ul style="list-style-type: none"> • Make sure the air conditioner plug is pushed completely into the outlet
	The fuse is blown/circuit breaker is tripped.	<ul style="list-style-type: none"> • Check the house fuse/circuit breaker box and replace the fuse or reset the breaker.
	Power failure	<ul style="list-style-type: none"> • The unit will automatically re-start when power is restored. • There is a protective time delay (approx. 3 minutes) to prevent tripping of the compressor overload. For this reason, the unit may not start normal cooling for 3 minutes after it is turned back on.
	The current interrupter device is tripped.	<ul style="list-style-type: none"> • Press the RESET button located on the power cord plug. • If the RESET button will not stay engaged, discontinue use of the air conditioner and contact a qualified service technician.
The Air Conditioner does not cool as it should	Airflow is restricted	<ul style="list-style-type: none"> • Make sure there are no curtains, blinds, or furniture blocking the front of the air conditioner
	The temperature control may not be set correctly.	<ul style="list-style-type: none"> • Lower the set thermostat temperature
	The air filter is dirty	<ul style="list-style-type: none"> • Clean the filter. See the Cleaning and Care Section of the manual.
	The room may be too warm	<ul style="list-style-type: none"> • Please allow time for the room to cool down after turning on the air conditioner.
	Cold air is escaping	<ul style="list-style-type: none"> • Check for open furnace registers and cold air returns
	The cooling coils are frozen	<ul style="list-style-type: none"> • See “Air Conditioner Freezing Up” below.
The Air Conditioner is freezing up	Ice blocks the air flow and stops the air conditioner from cooling the room	<ul style="list-style-type: none"> • Set the MODE dial to HIGH FAN or HIGH COOL and set the thermostat to a higher temperature
The Remote Control is not working	The batteries are inserted incorrectly	<ul style="list-style-type: none"> • Check the position of the batteries.
	The batteries may be dead	<ul style="list-style-type: none"> • Replace the batteries

TROUBLESHOOTING (CONT.)

PROBLEM	POSSIBLE CAUSES	SOLUTIONS
Water is dripping outside	Hot and humid weather.	<ul style="list-style-type: none">• This is normal
Water is dripping inside the room	The air conditioner is not correctly tilted outside.	<ul style="list-style-type: none">• For proper water drainage, make sure the air conditioner is slightly tilted downward from the front of the unit to the rear.
Water collects in the base pan	Moisture removed from the air is draining into the base pan.	<ul style="list-style-type: none">• This is normal for a short period in areas with low humidity and normal for a longer period in areas with high humidity.