

CONTENT

1. Return & Warrantly	1
2. Before Starting	2
3. Components	3
4. Assembly Steps	4
5. FAQs	6

BEFORE STARTING

Before Using Product



- Read each step carefully before starting. It is very important that each step is performed in the correct order. If these steps are not followed in sequence, assembly difficulties will occur.



- Make sure all parts are included. Most board parts are labeled or stamped on the raw edge.



- Recommended # of people needed for assembly: 1 (however it is always better to have an extra hand).
Estimated assembly time is 15-20mins.



- Work in a spacious area and near where the unit will be used, preferably on a carpet, or use a piece of the cardboard packaging to protect your floor and product.



- For a smooth assembly process, we suggest you keep a lite tightness for all the screws during assembly. After the whole product is assembled, firmly tighten all the screws.



WARNING :

- Do not allow children to climb on unit
- Serious or fatal crushing injuries can occur from furniture tip-over. To prevent this furniture from tipping over, it must be permanently fixed to the wall. Fixing devices for the wall are not included since different wall materials require different types of fixing devices. Use fixing devices suitable for the walls in your home. For advice on suitable fixing systems, contact your local specialized dealer
- Avoid sharp objects or corrosive chemicals to prevent damage to the product
- During assembly, keep parts and packaging materials away from children and pets as there could be potential injury and choking hazards

Components

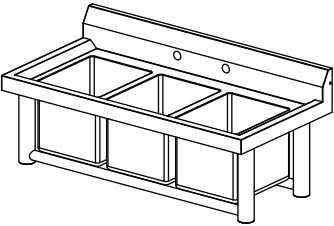
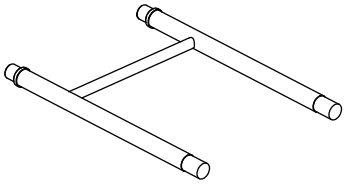
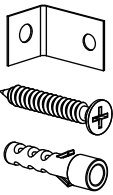
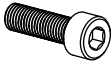
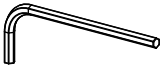
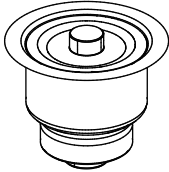
1 	2 	3 
Sink x1	Leg x2	Wall Mounting Bracket x2
4 	5 	6 
Screw x2	6mm Allen key x1	Drain x3

Take your time!
You will like it!

ASSEMBLY STEPS

STEP 1

Insert the two legs.

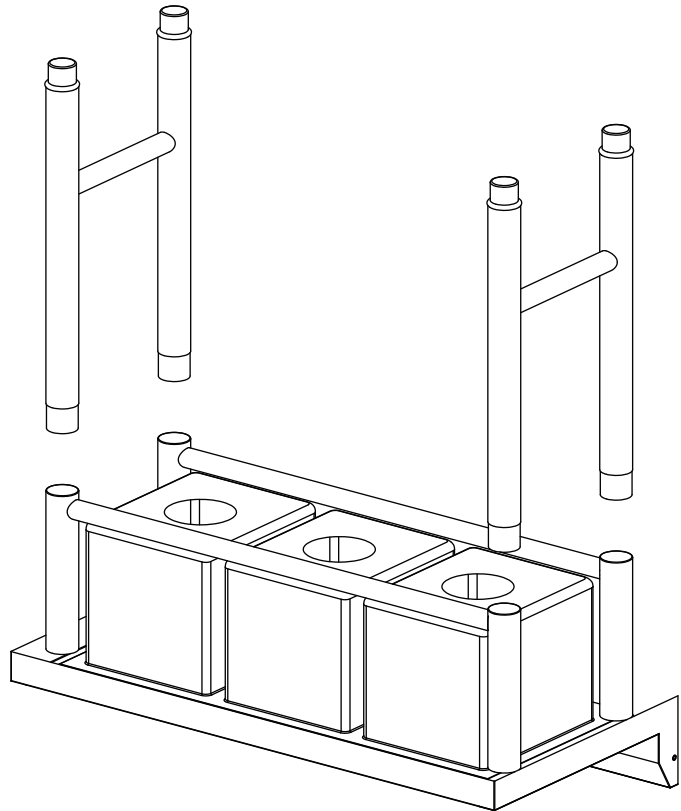

STEP 2

Install the drain and downpipe.

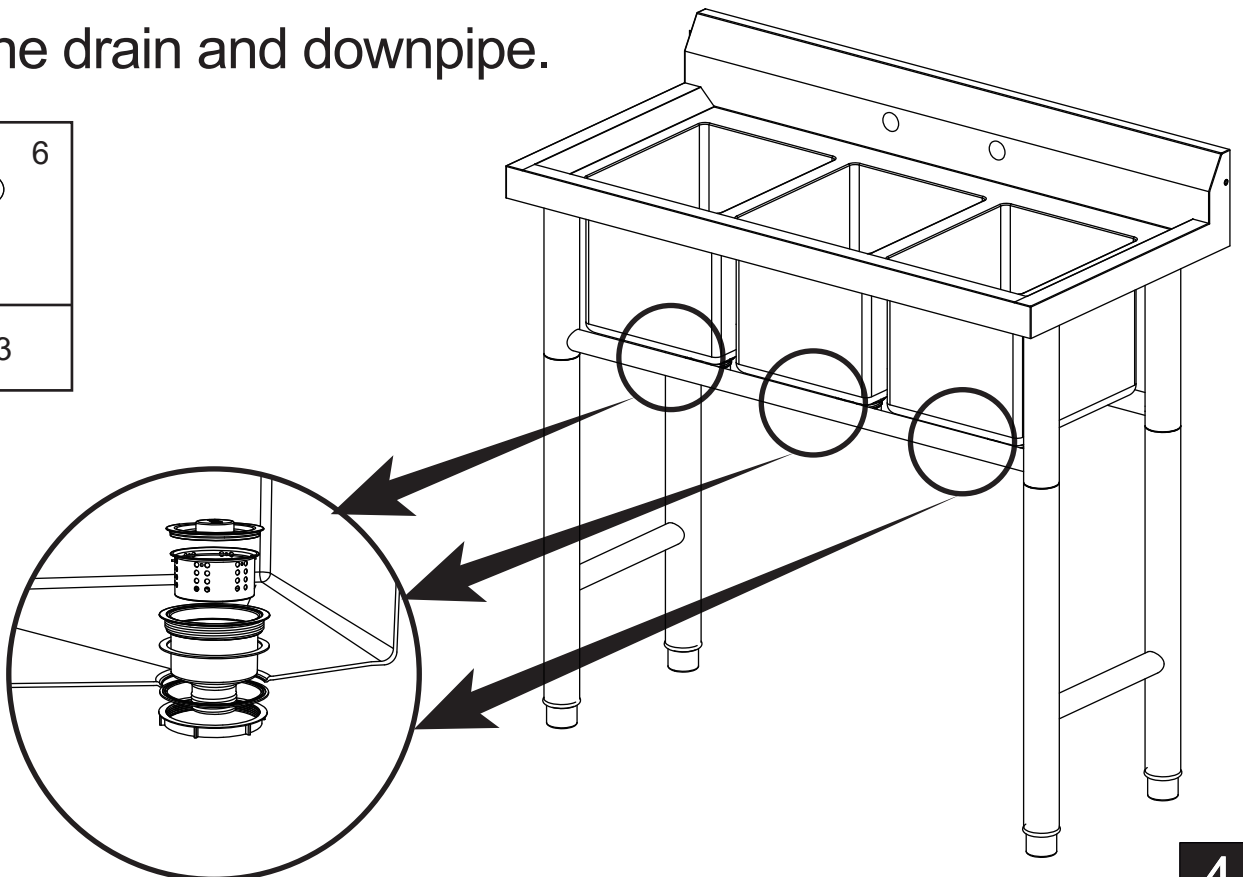
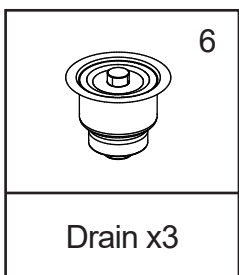

STEP 3

Install the wall mounting brackets

