

PLANCHA GAS GRILL USER MANUAL

Models: TP42-73

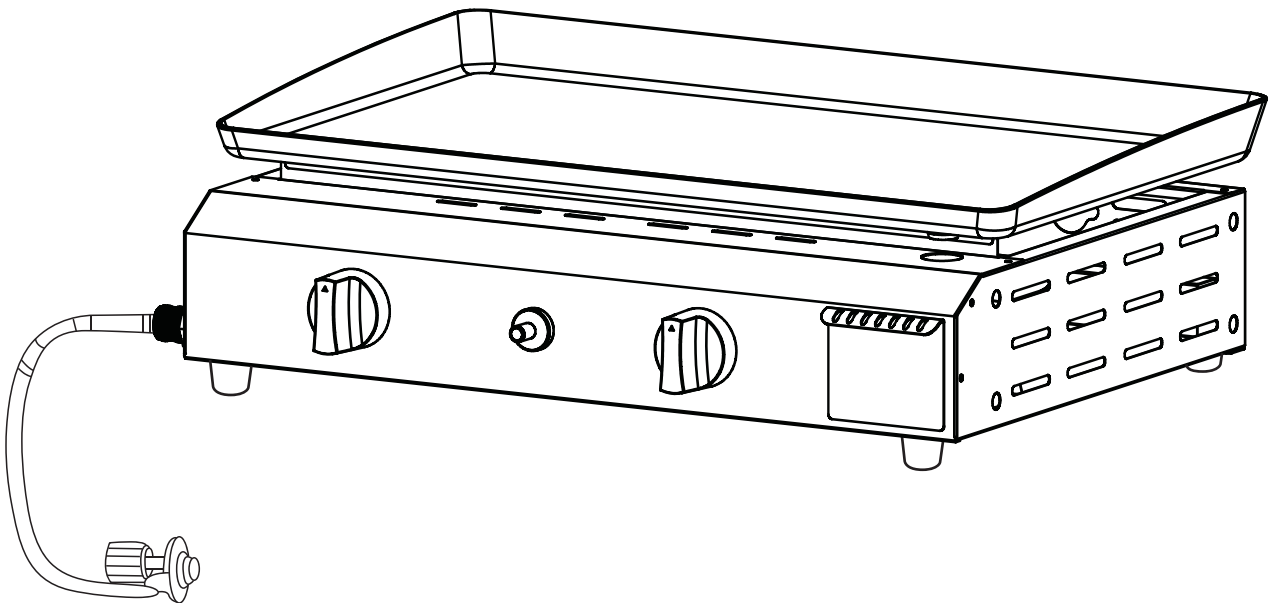

WARNING/DANGER

- Assemble grill on a flat, level, and soft surface.
- Do not use power tools for assembly.
- Use outdoors only!
- Read all precautions and instructions in this manual before using this equipment.
- Save this manual for future reference.
- Keep children and pets away.

CUSTOMER SERVICE INFORMATION

Thank you for purchasing

PLANCHA GAS GRILL

MODEL# TP42-73

If you have an issue with your item. Please report items that are damaged or missing parts within three days of delivery.

We want all of our customers to be completely satisfied with their purchase. Take time to review the contents of the product you have just received to make sure that all of the parts are included. If you find that any parts are missing or damaged. we will provide replacement parts at no charge within 30 days of purchase.

Please keep in mind that for select damaged part replacement requests. we will require a photo for submission.

Our warranty claims are fulfilled by the replacement of damaged parts and the payment of no quality problem return postage costs borne by the purchaser.

WARRANTY

Pursuant to applicable laws, the Owner has several rights in case the product is defective. Those rights include supplementary performance or replacement, abatement of the purchasing price, and compensation. These and other statutory rights remain unaffected by this Warranty provision. In fact, this Warranty grants additional rights to the Owner that are independent from statutory Warranty provisions.

LIMITED WARRANTY

- Abuse, misuse, alteration, modification, misapplication, vandalism, neglect, improper assembly or installation, and failure to properly perform normal and routine maintenance;
- Insects (such as spiders) and rodents (such as squirrels), including but not limited to damage to burners and/or gas hoses;
- Exposure to salt air and/or chlorine sources such as swimming pools and hot tubs/spas
- Severe weather conditions such as hail, hurricanes, earthquakes, tsunamis or surges, tornadoes or severe storms.
- Acid rain and other environmental factors.

The use and/or installation of parts on product that are not genuine original parts will void this Warranty, and any damages that result hereby are not covered by this Warranty. Any conversion of a gas grill not performed authorized service technician will void this Warranty.

We do not accept return in following situation:- You have been bought the products more than 30 days.

- Inappropriate Behavior (such as assembly, customer personal preferences, man-made damage, etc.).
- Returns without original package.
- Returned item is damaged.

DISCLAIMERS

APART FROM THE WARRANTY AND DISCLAIMERS

AS DESCRIBED IN THIS WARRANTY STATEMENT, THERE ARE EXPLICITLY NO FURTHER WARRANTY OR VOLUNTARY DECLARATIONS OF LIABILITY GIVEN HERE WHICH GO BEYOND THE STATUTORY LIABILITY APPLYING TO US.

THE PRESENT WARRANTY STATEMENT ALSO DOES NOT LIMIT OR EXCLUDE SITUATIONS OR CLAIMS WHERE US HAS MANDATORY LIABILITY AS PRESCRIBED BY STATUTE.

YOU ASSUME THE RISK AND LIABILITY FOR LOSS, DAMAGE, OR INJURY TO YOU AND YOUR PROPERTY AND/OR TO OTHERS AND THEIR PROPERTY ARISING OUT OF THE MISUSE OR ABUSE OF THE PRODUCT OR FAILURE TO FOLLOW INSTRUCTION IN THE ACCOMPANYING OWNER'S MANUAL.

THIS WARRANTY APPLIES TO PRIVATE SINGLE FAMILY HOME OR APARTMENT USE ONLY AND DOES NOT APPLY TO GRILLS USED IN COMMERCIAL, COMMUNAL OR MULTI-UNIT SETTINGS SUCH AS RESTAURANTS, HOTELS, RESORTS, OR RENTAL PROPERTIES.

WE MAY FROM TIME TO TIME CHANGE THE DESIGN OF ITS PRODUCTS. NOTHING CONTAINED IN THIS WARRANTY SHALL BE CONSTRUED AS OBLIGATING TO INCORPORATE SUCH DESIGN CHANGES INTO PREVIOUSLY MANUFACTURED PRODUCTS. NOR SHALL SUCH CHANGES BE CONSTRUED AS AN ADMISSION THAT PREVIOUS DESIGNS WERE DEFECTIVE.

IMPORTANT SAFETY INFORMATION

DANGER, WARNING, AND CAUTION

Statements are used throughout this Owner's Manual to emphasize critical and important information. Read and follow these statements to help ensure safety and prevent property damage. The statements are defined below.

▲ DANGER: Indicates a hazardous situation which, if not avoided, will result in death or serious injury.

▲ WARNING: Indicates a hazardous situation which, if not avoided, could result in death or serious injury.

▲ CAUTION: Indicates a hazardous situation which, if not avoided, could result in minor or moderate injury.

INSTALLATION AND ASSEMBLY

▲ DANGER: This grill is not intended to be installed in or on recreational vehicles or boats.

▲ WARNING: Do not use this grill unless all parts are in place and the grill was properly assembled according to the assembly instructions.

▲ WARNING: Do not build this model of grill in any built-in or slide-in construction.

▲ WARNING: Do not modify the appliance (grill). Liquid propane gas is not natural gas. The conversion or attempted use of natural gas in a liquid propane gas unit or liquid propane gas in a natural gas unit is unsafe and will void your warranty.

In the United States, installation must conform with local codes or, in the absence of local codes, with either the National Fuel Gas Code, ANSI Z223.1/NFPA 54, Natural Gas and Propane Installation Code, CSA B149.1; or Propane Storage and Handling Code, B149.2; or the Standard for Recreational Vehicles, ANSI A119.2/NFPA 1192, and CSA Z240 RV Series, Recreational Vehicle Code, as applicable.

OPERATION

▲ DANGER: Only use the grill outdoors in a well-ventilated area. Do not use in a garage, building, breezeway, tent, any other enclosed area, or beneath overhead combustible construction.

▲ DANGER: Do not use the grill in any vehicle or in any storage or cargo area of any vehicle. This includes, but is not limited to, cars, trucks, station wagons, mini-vans, sport utility vehicles, recreational vehicles, and boats.

▲ DANGER: Do not use the grill within 24 inches (61 cm) of combustible materials. This includes the top, bottom, back and sides of the grill.

▲ DANGER: Keep the cooking area clear of flammable vapors and liquids such as gasoline, alcohol, etc., and combustible materials.

▲ DANGER: This appliance (grill) must be kept away from flammable materials during use.

▲ DANGER: Do not put a grill cover or anything flammable on, or in the storage area under the grill while it is in operation or is hot.

▲ DANGER: Should a grease fire occur, turn off all burners and leave lid closed until fire is out.

▲ WARNING: Accessible parts may be very hot. Keep young children away.

▲ WARNING: The use of alcohol, prescription drugs, non-prescription drugs, or illegal drugs may impair the consumer's ability to properly and safely assemble, move, store, or operate the grill.

▲ WARNING: Never leave the grill unattended during pre-heating or use. Exercise caution when using this grill. The entire cookbox gets hot when in use.

▲ WARNING: Do not move the appliance (grill) during use.

▲ WARNING: Keep any electrical supply cord and the fuel supply hose away from any heated surfaces.

Storage and/or Nonuse

▲ WARNING: Turn off the gas supply at the gas cylinder (tank) after use.

▲ WARNING: LP tanks must be stored outdoors out of the reach of children and must not be stored in a building, garage, or any other enclosed space.

▲ WARNING: After a period of storage and/or nonuse, the grill should be checked for gas leaks and burner obstructions before use.

▲ Storage of the grill indoors is permissible only if the LP tank is disconnected and removed from the grill. California Proposition 65.

▲ WARNING: Combustion byproducts produced when using this product contain chemicals known to the state of California to cause cancer, birth defects, or other reproductive harm.

▲ PROPOSITION 65 WARNING: Handling the brass material on this product exposes you to lead, a chemical known to the state of California to cause cancer, birth defects, or other reproductive harm. Wash hands after handling this product.

▲ DANGER

If you smell gas:

- Shut off gas to the appliance (grill).
- Extinguish any open flame.
- If odor continues, keep away from the appliance (grill) and immediately call your gas supplier or your fire department.

IMPORTANT INFORMATION ABOUT LP GAS & GAS CONNECTIONS

What Is LP Gas?

Liquefied petroleum gas, also called LP, LP gas, liquid propane, or simply propane or butane, is the flammable, petroleum-based product used to fuel your grill. It is a gas at moderate temperatures and pressure when it is not contained. But at moderate pressure inside a container, such as a tank, LP is a liquid. As pressure is released from the tank, the liquid readily vaporizes and becomes gas.

Safe Handling Tips For LP Tanks

- A dented or rusty liquid propane tank may be hazardous and should be checked by your liquid propane supplier. Do not use a liquid propane tank with a damaged valve.
- Although your liquid propane tank may appear to be empty, gas may still be present, and the tank should be transported and stored accordingly.
- The LP tank must be installed, transported, and stored in an upright, secure position. LP tanks should not be dropped or handled roughly.
- Never store or transport the LP tank where temperatures can reach 125° F (51.7° C) (the tank will become too hot to hold by hand).
- Place dust cap on cylinder valve outlet whenever the cylinder is not in use. Only install the type of dust cap on the cylinder valve outlet that is provided with the cylinder valve. Other types of caps or plugs may result in leakage of propane. LP Tank Requirements.
- The tank must be approximately 18¼ inches (46.35 cm) high and 12¼ inches (31.1 cm) in diameter with a marked 20 pound (9.07 kg) LPG capacity or 47.6 pound (21.6 kg) water capacity as stated by the manufacturer. Other tanks may be acceptable provided they are compatible with the grill retention means (tank scale).
- The tank used must be constructed and marked in accordance with the Specifications for LP gas Cylinders of the U.S. Department of Transportation (D.O.T.).
- Tanks must be provided with a listed OPD (Overfilling Prevention Device) and a Type 1 (CGA 791) tank connection. The tank connection must be compatible with the grill connection.
- The tank must include a collar to protect the tank valve.
- Tanks must have a D.O.T. certification (A), and a testing date (B) that is within five years of current use.

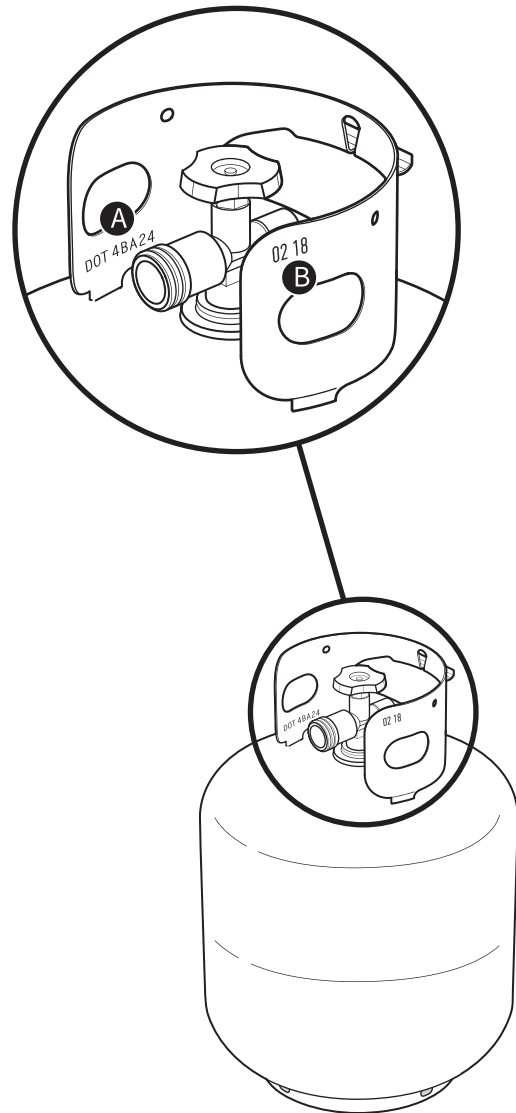

IMPORTANT INFORMATION ABOUT LP GAS & GAS CONNECTIONS

What is a Leak Check?

Once the LP tank is properly installed, it is necessary to perform a leak check. A leak check is a reliable way to verify that gas is not escaping after you connect the tank. The fuel system in your grill features factory-made connections that have been thoroughly checked for gas leaks and the burners have been flame-tested. We recommend performing a thorough leak check after assembly, as well as annually.

Checking for Gas Leaks

- 1) Wet fittings with a soap and water solution, using a spray bottle, brush, or rag. You can make your own soap and water solution by mixing 20% liquid soap with 80% water; or, you can purchase leak check solution in the plumbing section of any hardware store.
- 2) Slowly open gas supply by turning tank valve counterclockwise while checking for bubbles.
- 3) If bubbles appear there is a leak:
 - a) If the leak is at the cylinder, turn off the gas. **DO NOT OPERATE THE GRILL.** Disconnect the tank and return the tank to your local retailer.
 - b) If the leak is at the regulator, turn off the gas. **NEVER ATTEMPT TO TIGHTEN THE REGULATOR WITH TANK VALVE OPEN. DO NOT OPERATE THE GRILL.**
 - c) If the leak is at any fittings indicated in illustration, re-tighten fitting with a wrench and recheck for leaks with soap and water solution. If leak persists, turn off the gas. **DO NOT OPERATE THE GRILL.**
 - d) If the leak is at any fittings indicated in illustration, turn off the gas. **DO NOT OPERATE THE GRILL.**
- 4) If bubbles do not appear, leak checking is complete:
 - a) Turn gas supply off at the tank and rinse connections with water.

NOTE: Since some leak test solutions, including soap and water, may be slightly corrosive, all connections should be rinsed with water after checking for leaks.

▲ DANGER: Do not use a flame to check for gas leaks. Be sure there are no sparks or open flames in the area while you check for leaks.

▲ DANGER: Leaking gas may cause a fire or explosion.

▲ DANGER: Do not operate the grill if there is a gas leak present.

▲ DANGER: If you see, smell, or hear the hiss of gas escaping from the liquid propane tank:

- 1) Move away from liquid propane tank.
- 2) Do not attempt to correct the problem yourself.
- 3) Call your fire department.

▲ DANGER: Always close the tank valve before disconnecting the regulator. Do not attempt to disconnect the gas regulator and hose assembly or any gas fitting while this grill is in operation.

▲ DANGER: Do not store a spare LP tank under or near this grill. Never fill the tank beyond 80% full. Failure to follow these statements exactly may result in a fire causing death or serious injury.

The Very First Time You Grill Perform an Initial Burn-Off

Heat the grill on the highest setting for at least 20 minutes prior to grilling for the first time.

Every Time You Grill Meal-to-Meal Maintenance

The Meal-To-Meal Maintenance plan includes the following simple, yet important, steps that should always be performed prior to grilling.

Check for Grease

Your grill was built with a grease management system that funnels grease away from food and into a disposable container. As you cook, grease is channeled down the slide-out grease tray and into a disposable drip tray that lines the catch pan. This system should be cleaned each and every time you grill to prevent fires.

1. Confirm that the grill is off and cool.
2. Remove the slide-out grease tray by pulling the tray out of the cabinet. Remove excess grease with a plastic scraper.
3. Remove the catch pan. Check for excessive amounts of grease in the disposable drip pan that lines the catch pan. Discard disposable drip pan when necessary and replace with a new one.
4. Reinstall all components.

Inspect the Hose

Routine inspection of the hose is necessary.

1. Confirm that the grill is off and cool.
2. Check hose for any signs of cracking, abrasions, or cuts. If the hose is found to be damaged in any way, do not use the grill.

Preheat the Grill

Preheating the grill is critical to successful grilling. Preheating helps to prevent food from sticking to the grate and gets the grate hot enough to sear properly. It also burns off residue of a previously cooked meal.

1. Open the grill lid.
2. Ignite your grill according to the ignition instructions in this Owner's Manual.
3. Preheat the grill with all burners on the start/high position for 15 minutes.

Clean the Cooking Grate

After preheating, any bits of food or debris left over from previous use will be easier to remove. Cleaned plancha will also prevent your next meal from sticking.

▲ DANGER: Do not line the slide-out grease tray or cookbox with aluminum foil.

▲ DANGER: Check the slide-out grease tray and catch pan for grease build-up before each use. Remove excess grease to avoid a grease fire.

▲ WARNING: Use caution when removing catch pan and disposing of hot grease.

▲ WARNING: Use heat-resistant barbecue mitts or gloves when operating grill.

▲ WARNING: If the hose is found to be damaged in any way, do not use the grill. Replace using only authorized replacement hose.

▲ WARNING: Keep ventilation openings around tank clear and free of debris.

OPERATION

Igniting the Grill

Using the Electronic Ignition System to Ignite the Grill

Each control knob operates an individual burner, and each burner ignites independently. Ignite the burners starting from left to right. All burners should be lit for preheating, however, all burners do not have to be lit while grilling.

- 1) Check that all burner control knobs are in the off position. Check by pushing in and turning knobs clockwise (A).
Note: It is important that all burner control knobs are in the off position before turning on the LP tank. If they are not, the flow limiting device built into the regulator will activate, limiting the flow of gas from the LP tank.
- 2) Turn the LP tank on by slowly turning the tank valve counterclockwise; wait 60 seconds (B).
Note: It is important that the LP tank is turned on slowly. If it is opened too quickly, the flow limiting device built into the regulator will activate, limiting the flow of gas from the LP tank.
- 3) Begin with the burner furthest to the left. Push the burner control knob in and turn it counterclockwise to the start/high position (C).
- 4) Push and hold the electronic ignition button (D). You will hear it ticking.
- 5) If the burner does not ignite, turn burner control knob to the off position and wait five minutes to allow the gas to clear before attempting to light the burner again.
- 6) If the burner ignites, repeat steps 4 through 6 to light the remaining burners.
Should the burners fail to ignite using the electronic ignition, refer to the TROUBLESHOOTING section. There you will find instructions on igniting the grill with a match to help determine the exact problem.

To Extinguish Burners

- 1) Push each burner control knob in and then turn clockwise all the way to the off position.
- 2) Turn gas supply off at the LP tank.

▲ **WARNING:** Each burner must be ignited individually by pushing the electronic ignition button.

▲ **WARNING:** If ignition does not occur within four seconds of attempting to light the first burner, turn the burner control knob to the off position. Wait five minutes to allow accumulated gas to dissipate, and then repeat the lighting procedure.

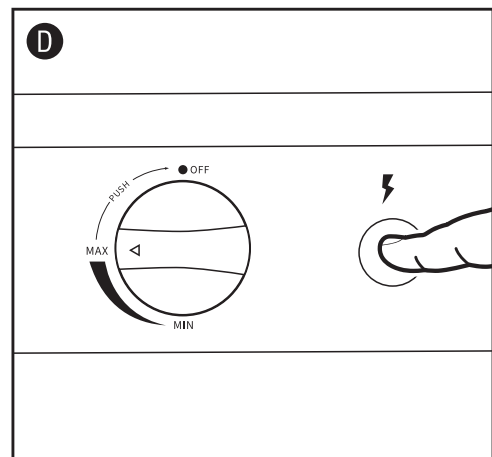
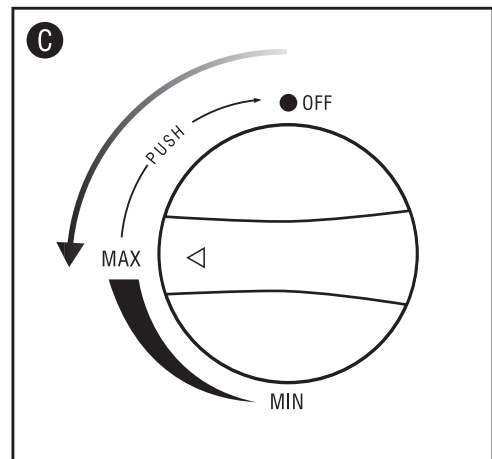
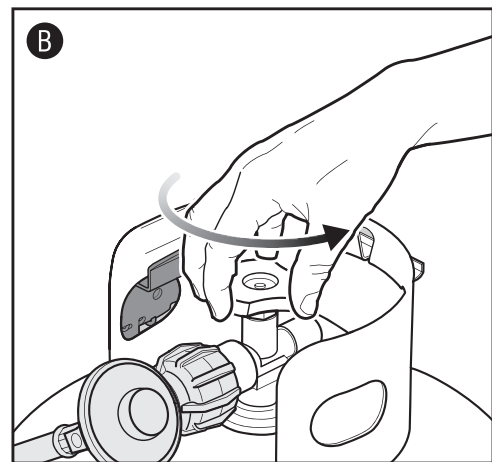
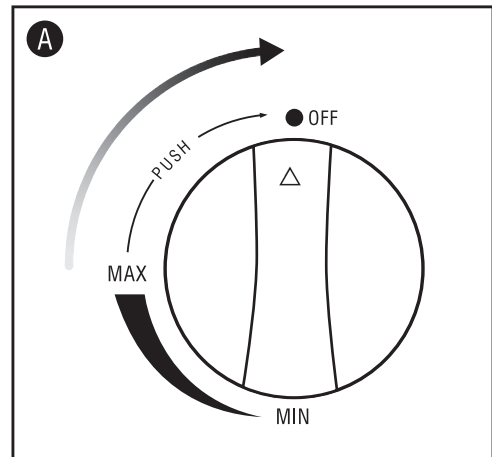

TIPS AND HINTS

Grilling Do's and Don'ts

Preheat each and every time

If the cooking plancha aren't hot enough, food will stick, and you will likely never have a chance of searing properly or developing those handsome grill marks. Even if a recipe calls for medium or low heat, always preheat the grill on the highest setting first.

Don't grill on dirty plancha

Tossing food onto the cooking plancha before they have been cleaned is never a good idea. Leftover "stuff" on the plancha acts like glue, binding it to the plancha and your new food. To avoid tasting last night's dinner on today's lunch, make sure you are grilling on a clean cooking grate. Once the plancha are preheated use a soft towel to make a clean smooth surface.

Be present in the process

Before firing up your grill, make sure that everything you need is within arm's reach. Don't forget your essential grilling tools, already oiled and seasoned food, glazes or sauces, and clean cooking platters for cooked food. Having to run back to your kitchen not only means missing out on the fun, but could also result in burning your food. French chefs call this "mise en place" Don't be afraid to experiment. (meaning, "put in place"). We call it "being present".

Create a little elbow room

Packing too much food onto the cooking plancha restricts your flexibility. Leave at least one-quarter of the cooking plancha clear, with plenty of space between each food item, in order to get your tongs in there and easily move the food around. Sometimes grilling involves split-second decisions and the ability to jockey food from one area to another. So give yourself enough room to operate.

Only flip once

What's better than a juicy steak with a deep sear and plenty of beautifully caramelized bits? The key to accomplishing these results is to keep your food in place. Sometimes we have the tendency to flip our food before it reaches the desirable level of color and flavor. In nearly all cases, you should turn food just once.

Know when to tame the flame

When grilling, sometimes the most important thing to know is when to stop. The most reliable way to test doneness of your food is to invest in an instant-read thermometer. This slim little gem will help you pinpoint that critical moment when your food is at its best.

Don't be afraid to experiment

Back in the 1950s, grilling meant one thing: meat (and only meat) charred over open flames. The modern day backyard chef doesn't need a kitchen in order to prepare a full course meal. Use your grill to make chargrilled appetizers, sides, and even desserts.

Cleaning and Maintenance

Cleaning the Inside of the Grill

Over time, the performance of your grill can diminish if it has not been maintained properly. Low temperatures, uneven heat, and food sticking to cooking plancha are all signs that cleaning and maintenance are overdue. When your grill is off and cool, start by cleaning the inside, from the top down. A thorough cleaning is recommended at least twice a year. Consistent use may require quarterly cleanings.

Cleaning the Cooking plancha

If you have been cleaning your cooking plancha as recommended, the debris on your plancha should be minimal.

- 1) With plancha installed wipe the debris off your cooking grate with a soft towel.
- 2) Take the plancha out and set aside.

Cleaning the Burners

Two areas on the burners that are key to optimum performance are the ports (small raised openings running along the length of the burners) and the spider/insect screens on the ends of the burner. Keeping these areas clean is essential for safe operation.

Cleaning the Burner Ports

- 1) Use a clean stainless steel bristle grill brush to clean the outside of the burners by brushing across the top of the burner ports.
- 2) When cleaning the burners, avoid damaging the ignition electrode by carefully brushing around it.

Cleaning the Spider Screens

- 1) Locate the ends of the burners on the underside of the control panel where they meet the valves.
- 2) Clean the spider/insect screens on each of the burners using a soft bristle brush.

▲ **WARNING:** Turn your grill off and wait for it to cool before thoroughly cleaning.

▲ **WARNING:** When cleaning the burners, never use a brush that has already been used to clean the cooking plancha. Never put sharp objects into the burner port holes.

▲ **CAUTION:** Do not place any grill components onto the side tables as they may scratch the paint or stainless steel surfaces.

▲ **CAUTION:** Do not use any of the following to clean your grill: abrasive stainless steel polishes or paints, cleaners that contain acid, mineral spirits or xylene, oven cleaner, abrasive cleansers (kitchen cleansers), or abrasive cleaning pads.

TROUBLE SHOOTING

MAIN BURNER(S) SYMPTOM

- Main burners or side burner do(es) not ignite when following the electronic ignition instructions in the “Operation” section of this owner's manual.

CAUSE

SOLUTION

There is a problem with gas flow.

If any burner does not ignite, the first step is to determine if there is gas flowing to the burner(s). To check this, follow the instructions below for “Lighting Your Grill with a Match.” If **match lighting IS NOT successful**, follow the “GAS FLOW” troubleshooting suggestions on the next page.

There is a problem with the electronic ignition system.

If any burner does not ignite, the first step is to determine if there is gas flowing to the burner(s). To check this, follow the instructions below for “Lighting Your Grill with a Match.” If **match lighting IS successful**, follow the instructions for “Checking the Components of the Electronic Ignition System.”

Lighting Your Grill with a Match

Using a Match to Determine if there is Gas Flow to the Main Burners

1) Open the grill lid.

2) Check that all burner control knobs (including side burner control knob) are in the off position. Check by pushing in and turning knobs clockwise.

Note: It is important that all burner control knobs are in the off position before turning on the LP tank. If they are not, the flow limiting device built into the regulator will activate, limiting the flow of gas from the LP tank.

3) Turn the LP tank on by slowly turning the tank valve counterclockwise; wait 60 seconds.

Note: It is important that the LP tank is turned on slowly. If it is opened too quickly, the flow limiting device built into the regulator will activate, limiting the flow of gas from the LP tank.

4) Begin with the burner furthest to the left. Put match in the matchstick holder and strike match. (Matchstick holder is located under right side table.) Insert lit match down through the cooking plancha, past the FLAVORIZER bars and next to the burner.

5) Push the burner control knob in and slowly turn it counterclockwise toward the start/high position.

6) Check that the burner is lit by looking through the cooking plancha and through the cutout in the FLAVORIZER bar.

7) If the burner does not ignite within 4 seconds, turn burner control knob to the off position and wait five minutes to allow the gas to clear before attempting to light the burner again. If repeated attempts fail, follow the gas flow troubleshooting instructions on the next page.

8) If the burner ignites, the problem lies in the ignition system. Follow the instructions for “Checking the Components of the Electronic Ignition System”.

9) Replace the matchstick holder by hanging underneath right side table.

TROUBLE SHOOTING

GAS FLOW SYMPTOM

- Grill does not reach desired temperature or heats unevenly.
- One or more of the burners fail to ignite.
- Flame is low when burner is on high position.
- Flames do not run the whole length of the burner.
- Burner flame pattern is erratic.

CAUSE

The “flow limiting device” has been activated. This safety feature built into the regulator restricts the gas flow in the event of a gas leak. You can inadvertently activate this safety feature without having a gas leak. This typically occurs when you turn on the gas at the LP tank and one or more of the control knobs are not in the off position. It may also occur if you turn on the LP tank too quickly.

SOLUTION

Reset the “flow limiting device” by closing the LP tank valve and turning all the burner control knobs to the off position. Wait five minutes to allow accumulated gas to dissipate. then ignite the grill again following the instructions in the “Operation” section.

The LP tank is low or empty.

Refill LP tank.

Fuel hose is bent or kinked.

Straighten fuel hose.

Burner ports are dirty.

Clean burner ports. Refer to “Cleaning the Burner Ports.”

SYMPTOM

- Gas is smelled in conjunction with burner flames that appear yellow and lazy.

CAUSE

Spider screens on the burners are obstructed.

SOLUTION

Clean spider screens. Refer to “Cleaning the Spider Screens” in the Product Care section. Also refer to the illustrations and information in this section about proper flame pattern and spider screens.

SYMPTOM

- The smell of gas and/or a light hissing sound.

CAUSE

The internal rubber seal in the LP tank valve could be damaged.

SOLUTION

Extinguish any open flame. Shut off gas to the appliance (grill). Inspect the rubber seal for damage. If damaged, return tank to place of purchase.

Connection between regulator and LP tank could be incomplete.

Extinguish any open flame. Shut off gas to the appliance (grill). Refer to LP TANK INSTALLATION & LEAK CHECKING section of your owner’s manual.

▲ **WARNING:** Do not attempt to make any repair to gas carrying, gas burning, ignition components or structural components without contacting Customer Service Department.

▲ **WARNING:** Failure to use genuine parts for any repair or replacement will void all warranty protection.

▲ **CAUTION:** The burner tube openings must be positioned properly over the valve orifices. Openings around tank clear and free of debris.

TROUBLE SHOOTING

Checking the Components of the Electronic Ignition System

When pressing the ignition button you should hear a ticking sound. If you cannot hear the ticking sound, check the battery, then check the wires.

Checking the Wires

There are two potential trouble spots that need to be checked:

- 1) Check that the ignition wires are connected securely to the terminals on the ignition button under the control panel.
- 2) Make sure the ignition wires are properly attached to the ignition module. The wire terminals are color coded to correspond with the terminals on the ignition module. The number of wires will vary per model.

PRODUCT CARE

Cleaning the Heat Deflectors

Located under the burners, the heat deflectors distribute heat evenly throughout the cookbox while cooking. Keeping heat deflectors clean will enhance the cooking performance of your grill.

- 1) Scrape the heat deflectors with a plastic scraper.
- 2) If necessary, brush the heat deflectors with a stainless steel bristle grill brush.
- 3) Remove heat deflectors and set aside.

Cleaning the Cookbox

Look inside the cookbox for any grease accumulation or leftover food particles. Excessive accumulation can cause a fire.

- 1) Use a plastic scraper to scrape debris off the sides and bottom of the grill into the opening in bottom of the cookbox. This opening leads debris into the slide-out grease tray.

Cleaning the Grease Management System

The grease management system consists of an angled slide-out grease cup. These components were designed to be easily removed, cleaned, and replaced; an essential step every time you prepare to grill.

Cleaning the Outside of the Grill

The outside of your grill may include stainless steel, porcelain-enameled, and plastic surfaces. We recommend the following methods based on the surface type.

Cleaning Stainless Steel Surfaces

Clean stainless steel using a non-toxic, non-abrasive stainless steel cleaner or polish designed for use on outdoor products and grills. Use a microfiber cloth to clean in the direction of the grain of the stainless steel. Do not use paper towels.

Note: Do not risk scratching your stainless steel with abrasive pastes. Pastes do not clean or polish. They will change the color of the metal by removing the top chromium oxide film coating.



Cleaning Painted, Porcelain-Enameled Surfaces and Plastic Components



Clean painted, porcelain-enameled and plastic components with warm soapy water, and paper towels or cloth. After wiping down the surfaces, rinse and dry thoroughly.

Cleaning the Outside of Grills that are in Unique Environments

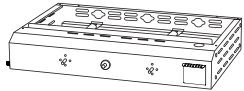
If your grill is subject to a particularly harsh environment, you will want to clean the outside more often. Acid rain, pool chemicals, and salt water can cause surface rusting to appear. Wipe down the outside of your grill with warm soapy water. Follow up with a rinse and thorough drying. Additionally, you may want to apply a stainless steel cleaner weekly to prevent surface rust.

ASSEMBLY INSTRUCTIONS

	Name	Pic	Qty
A	Griddle Body Assembly		x1
B	Control knob		x2
C	Bakeware		x1

	Name	Pic	Qty
D	Regulator/Hose Assembly		x1
E	Stove foot		x4

