

## RUBIK III

**ASSEMBLY INSTRUCTIONS** - please keep for future reference.  
**IMPORTANT** - please read these instructions before assembly.  
**CUSTOMER SUPPORT** - [support@linsyhome.com](mailto:support@linsyhome.com)



# General care and maintenance

## Packing



The sofa comes in several boxes, and we shipped all the packages at the same time but somehow FEDEX separated them, so the packages may be delivered at different times. If you have any questions about other tracking numbers, please feel free to contact us.



During the unpacking process, please pay attention to avoid scratching the product surface fabric with sharp objects;



The hardware box is placed in the seat frame and under the armrest

## Compression / Repair



The cushions arrived vacuum sealed and took at least 72 hours to fully fluff back up and fabric wrinkles disappear.



Using the correct technique to pat the cushions, as well as warming up the cushions with a hair dryer or sunshine, can accelerate the recovery process.

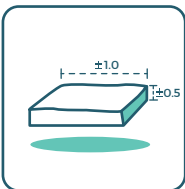

The cushion is soft and has been compressed and packaged. There will be a slight size error after rebounding. It is normal for the length and width to be  $\pm 1\text{cm}$  and the thickness to be  $\pm 0.5$ .









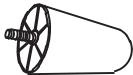
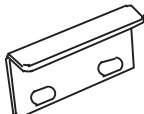
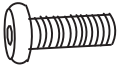

Normal use, spraying water, and drying with a hair dryer can accelerate the disappearance of fabric wrinkles

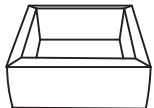





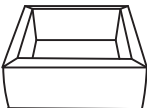

# Components

Please check if all the pieces listed below are received.

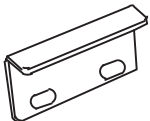
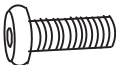

## 【Package A】 Seat

(B) *4  Sofa foot	(L) *4  L-shaped hardware	(D) *12  M6*25mm Hexagonal screw	(E) *1  Hexagon screwdriver	(F) *1  Seatboard	(A) *1  Sofa base
(G) *1  Seat cushion	(U) *2  U-shaped hardware	(H) *1  backrest	(I) *1  Back cushion	(Z) *2  Z-shaped hardware	(J) *4  Non-slip Mat

## 【Package B】 Ottoman

(A) *1  Sofa base	(B) *4  Sofa foot	(L) *4  L-shaped hardware	(D) *8  M6*25mm Hexagonal screw	(U) *2  U-shaped hardware	(E) *1  Hexagon screwdriver
(F) *1  Seatboard	(G) *1  Seat cushion	(J) *4  Non-slip Mat			

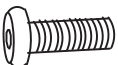
## 【Package C】 Armrest

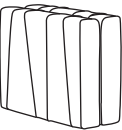
(Z) *4  Z-shaped hardware	(D) *8  M6*25mm Hexagonal screw	(E) *1  Hexagon screwdriver	(C) *2  Left and right armrest		
--	---	--	---	--	--

# Assembly Instructions

Please use the screws correctly, otherwise the product will be seriously damaged!

## Step 1

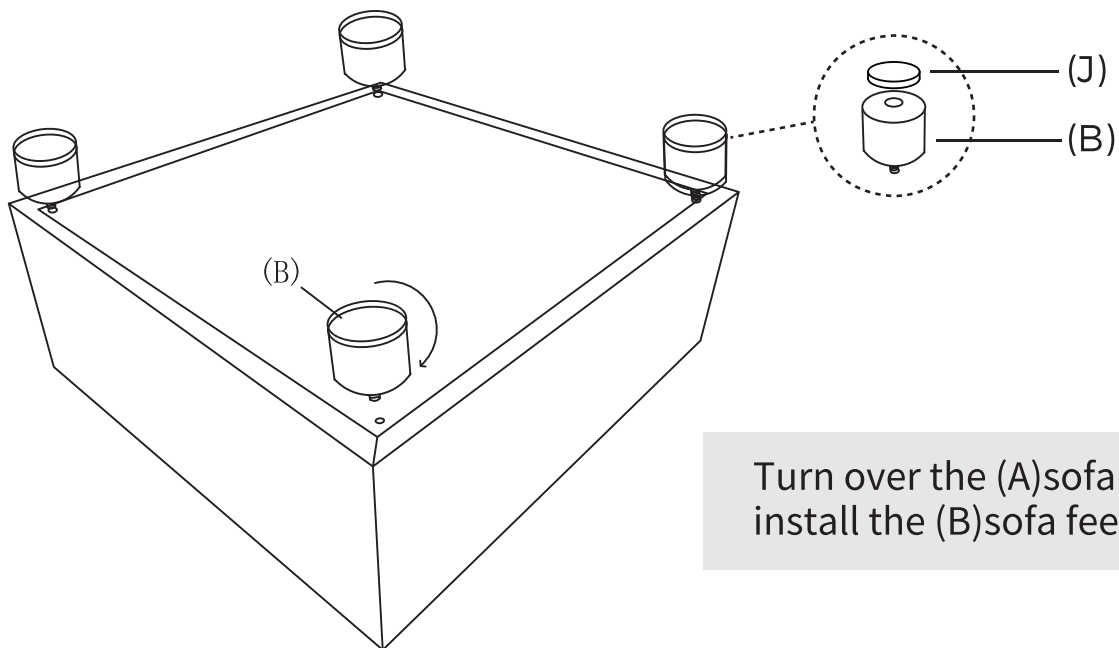

Turn over the (A)sofa base and install the (B)sofa feet

## Step 2

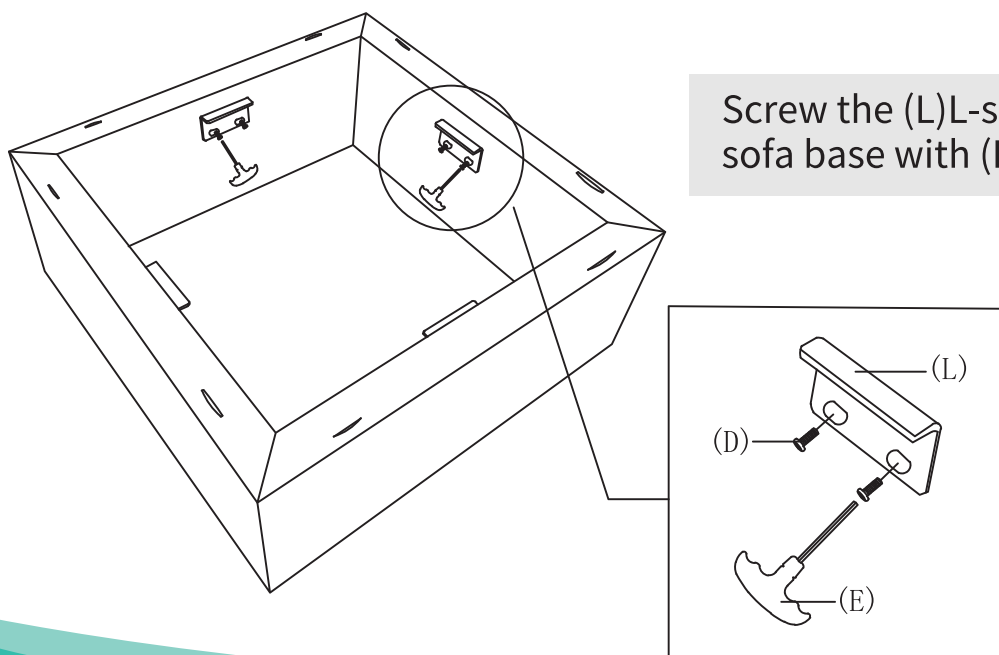

Screw the (L)L-shaped hardware into the sofa base with (E)hexagon screwdriver

# Assembly Instructions

## Step 3

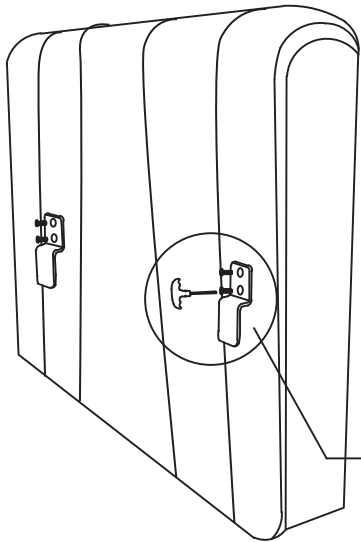

Screw the (Z)Z-shaped hardware into the sofa armrest and backrest with (E)hexagon screwdriver

※Please note: Four Z-shaped hardware and screws are inside the bottom of the armrest

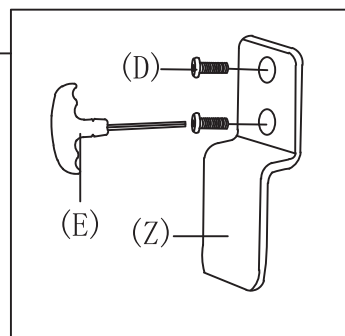

## Step 4

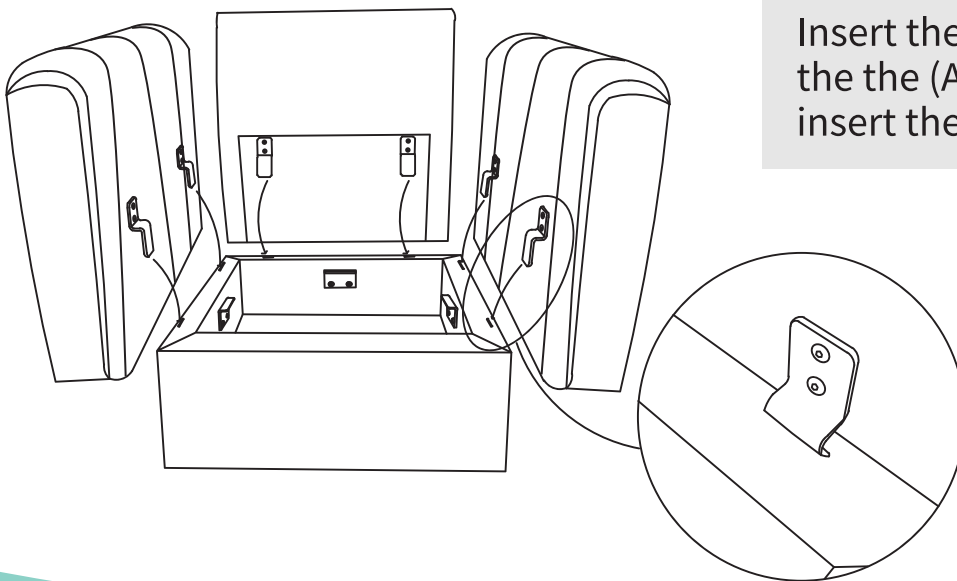

Insert the (H)backrest cushions into the the (A)sofa base first, and then insert the (C)armrests

# Assembly Instructions

## Step 5

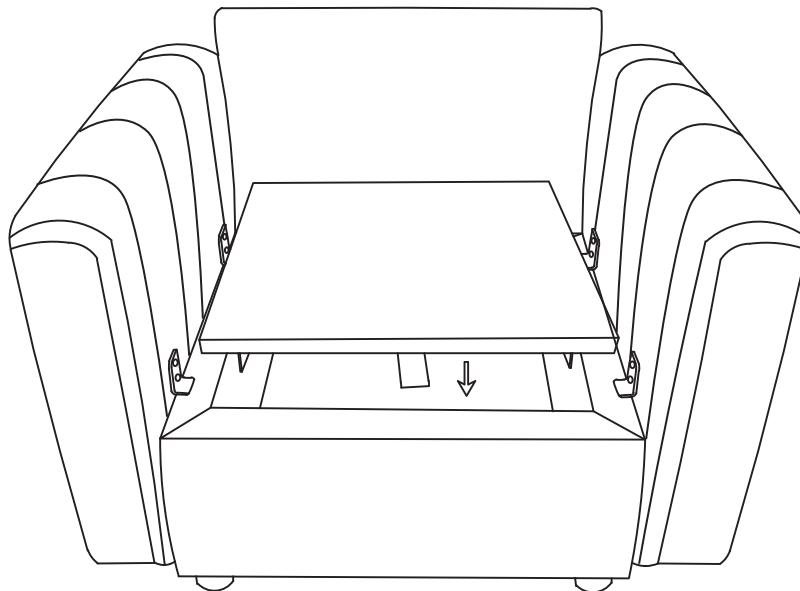

Put the (F) seatboard on the sofa base

## Step 6

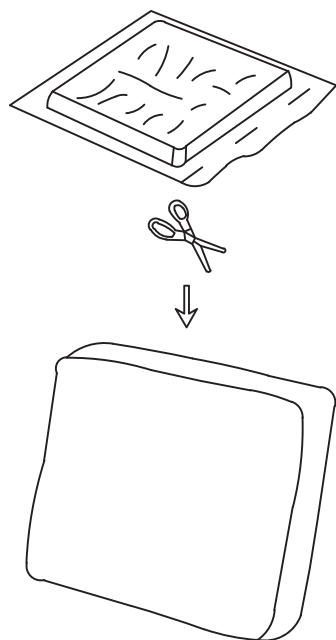

Cut the (G)&(I) compression bag of cushions

# Assembly Instructions

## Step 7

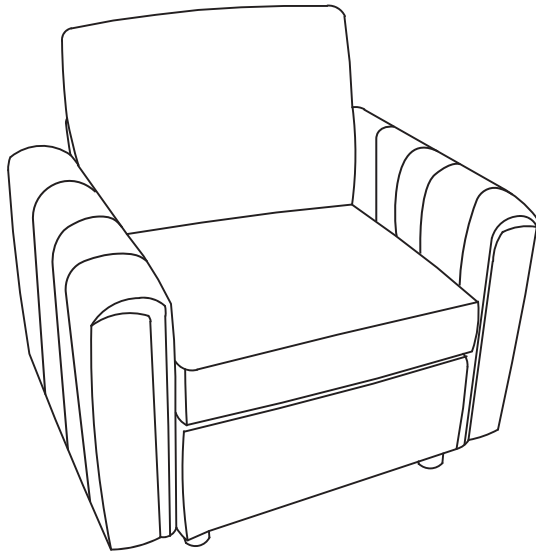

Put the cushion on the (A)sofa base then you have the single sofa done

## Step 8

Connect the (A)sofa bases with the (U)U-shaped metal sheet

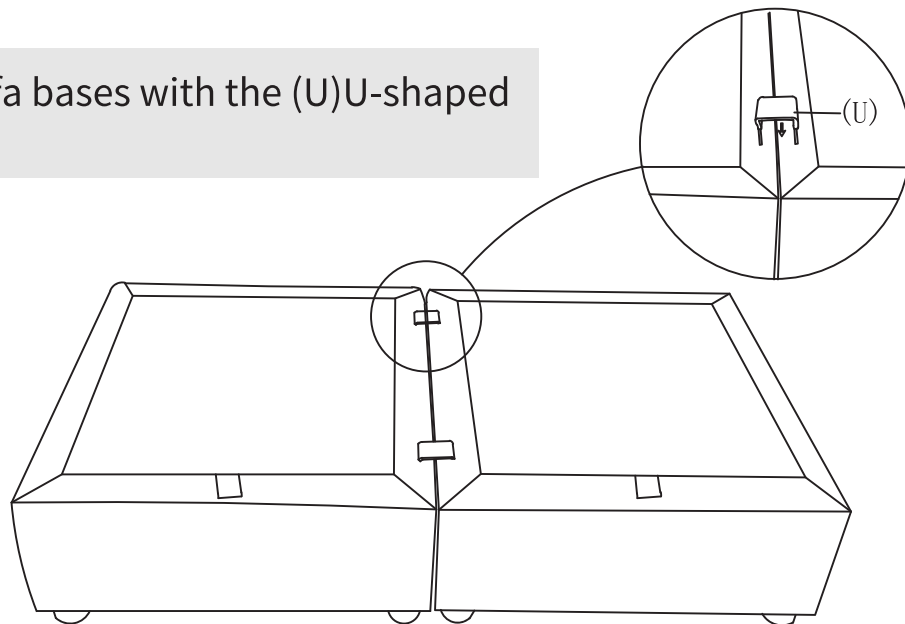

# Assembly Instructions

## Step 9

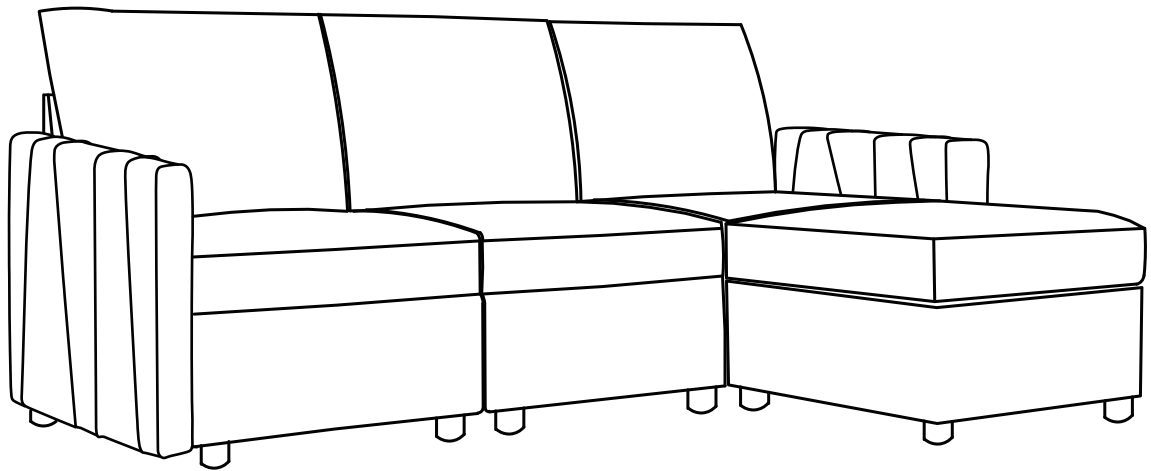

Then insert the backrests and armrests in the corresponding position.  
You have the sectional sofa done