

Setup Software Installation & Operation Manual

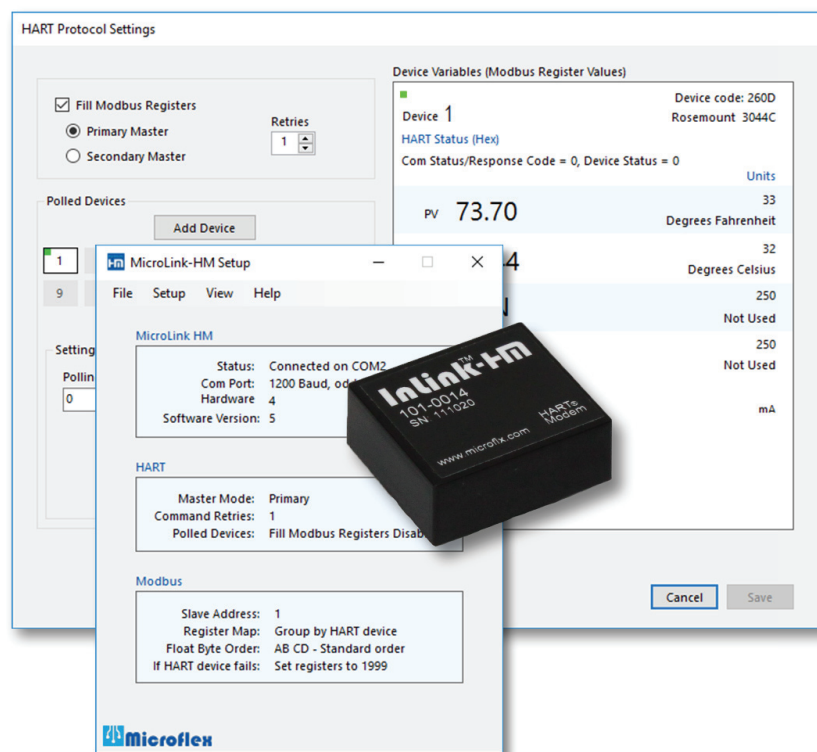

InLink-HM 101-0014 is a complete OEM HART® protocol modem module with managed HART host timing to function as either a primary or secondary HART host - eliminating the need for external CD monitoring and RTS control. It can also be used as a HART to modbus accumulator polling up to 16 HART devices. For evaluation and development support, the InLink-HM module is compatible with the 101-0003 InLink evaluation board and pin-compatible with the InLink-TC module. InLink-HM module is also compatible with InLink-HM Evaluation Board RS-485 (part number 101-0093). Compatibility of InLink-HM module with InLink-HM evaluation board RS-485 requires Firmware version 6 or higher.

InLink-HM can be easily interfaced to most micro-controllers using only two I/O pins; transmit data (TXD), and received data (RXD) typically connected to USART I/O. Unlike many HART modems, communications direction control is managed internally so there is no need to handle tricky request-to-send (RTS) and carrier-detect (CD) handshake timing, greatly simplifying software development.

As a HART protocol modem - InLink-HM receives packets on the TXD input pin, at the configured baud rate and parity setting, and then sends the packet to the HART loop. After sending the packet, InLink-HM switches the modem to receive, to acquire the reply. The reply is transmitted on the RXD output pin at the configured baud rate and parity setting. The DE output pin provides RS-485 Half duplex transceiver data direction control.

InLink-HM can be configured to continuously poll up to 16 HART devices and save the HART device data into modbus registers. Modbus RTU commands can then be used to read the HART device data. Configuration is simple using the included HM Configuration software. Settings are saved in modbus registers so modbus RTU commands can also be used to edit the InLink settings. InLink-HM module can be restored to default settings using the HM Configuration software.

InLink-HM Block Diagram

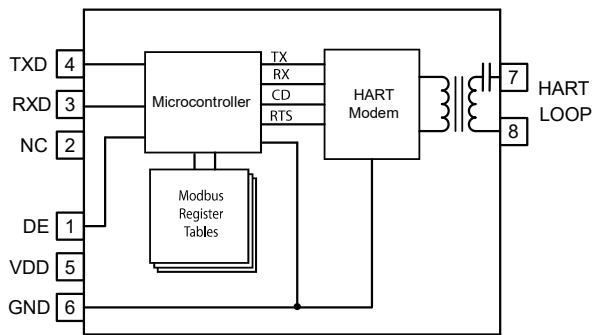

Operation Description

InLink-HM includes a complete HART protocol modem with transformer isolation and capacitor coupling to the HART loop. The two HART pins can be connected directly to the loop without concern for polarity. The HART loop resistor, typically 250 ohms, is not included but is required. The TXD, RXD, and DE I/O pins are compatible with 3.3 volt logic and the module requires an external 3.3 volt power supply connected to VDD.

HART Modem Mode

InLink-HM ships configured to function as a typical HART protocol modem and is compatible with most HART configuration and test software. Included on the CD is the PACTware FDT frame, HART Protocol DTM, and Microflex Generic DTM software. For information on installing PACTware and the DTM, please reference the PACTware Quick Start Guide. Also included is a HART device addressing utility which can be used to configure the polling address in HART devices for multi-drop systems.

To function as a HART protocol modem the module is typically configured for 1200 baud, odd parity with modbus register filling disabled. When set to use higher baud rates InLink-HM will receive the HART command at the higher baud rate then transmit through the modem at 1200 baud odd parity. The HART reply packet is received by the InLink-HM modem and then transmitted back at the higher baud rate on the RXD output pin. HART packets must be formatted in the standard format and include the "FF" preamble characters. If InLink-HM receives "FF" (hex) as the first byte in a new packet it is assumed to be a HART packet and InLink will switch to the HART modem mode and stop filling modbus registers if enabled. If no HART commands are received over the serial port after 30 seconds, InLink-HM will return to polling and filling modbus registers. Also, if a modbus command is received InLink will exit HART mode and return to polling and filling modbus registers. Modbus packets begin with the slave address or universal address 0 but never FF (hex).

Fill Modbus Registers Mode

InLink-HM can be configured to continuously poll a HART loop of 1 to 16 HART devices and fill modbus registers with HART device variable data - up to 4 variables per device. When enabled, the module will work through a list of HART device polling addresses and use HART command 3 to read the primary, secondary, tertiary, quaternary variables, as well as the loop current. Values are saved in 16-bit signed registers and single precision floating point (two 16-bit registers per floating point value). The register values can then be read using modbus command 3. Registers can be grouped by HART device or variable type.

Configuration

The InLink-HM configuration is set using a few modbus setup registers. Refer to Setup Registers section in this manual for details. The configuration can also be changed using the Microflex HM Configuration program running on a Microsoft Windows PC. The InLink-HM module will need to be connected to a PC serial port to use the HM Configuration software. This can be done using the InLink evaluation board (part number 101-0003). Microflex also offers the InLink-HM Evaluation Board RS-485 (part number 101-0093). InLink-HM Evaluation Board RS-485 includes the necessary RS-485 half duplex transceivers to connect the InLink-HM module to an RS-485 network bus.

Power Supply - 3.3V / GND

InLink-HM requires an external 3.3 volt DC power supply (3.6 volts max). When using the InLink evaluation board a 3.3 volt supply should be used. To prevent any noise interference to the HART modem the power supply should be heavily filtered and decoupled to ground. Typical supply current is less than 5 mA. Wait at least 25 milliseconds after power on before starting any communications transactions.

Serial Port - TXD / RXD

The InLink-HM serial port uses 3.3 volt CMOS logic levels. The InLink evaluation board (101-0003) provides the transceivers necessary to connect the module directly to an RS-232 serial port. The TXD and RXD lines will typically connect to microcontroller IO pins in your OEM application.

Driver Enable - DE

The Driver Enable pin is a Digital Output, Active High. A logic high indicates that a HART or modbus reply packet is being shifted out serially on RXD. DE can be used for RS-485 transceiver direction control. Firmware version 6 or higher is required for Driver Enable (DE) functionality.

HART Loop - HART

These two pins connect to the HART loop. The internal modem includes transformer isolation, AC capacitor coupling, and line transient protection. The two pins are designed to connect directly to a HART protocol loop. Connections can be made across the HART 230 to 600 ohm loop resistor or across the HART device. All HART loops are required to have the loop resistor.

HART Device Polling Address

Each HART device has a polling address. By default devices are set to use polling address 0 with the current output enabled. Before a HART master can send commands to a device it must first use the polling address to learn the unique 5-byte device address. HART command 0 is sent with the polling address set to 0. The HART device replies with a packet that includes the necessary information to build the 5-byte long address. With the long address learned, the HART master can then send any other HART command to the device.

For multi-drop loops where more than one HART device is in the same loop each HART device must be set to have a unique polling address. For HART version 3 - 5 the polling address for multi-drop devices can be 1 to 15. For HART version 6 and higher devices the polling address can be 1 to 63. In multi-drop mode the current output is set to a fixed value and cannot be used for a process value.

Setting the HART Device Address

HART command 6 is used to set the device's polling address. The HART host must first use command 0 to learn the long address. The device polling address should only be changed on a HART device that is not controlling or measuring a live process since the change may alter the current output as well as interfere with a HART master's ability to communicate with the device. The configuration software for your HART device should include the capability to set the device's polling address. The Microflex HART Host app includes the capabilities to scan for and change a device's HART address.

InLink-HM HART - Modbus Accumulator

In addition to being a HART Protocol Modem module, the InLink HM can be set to collect and store process variable information from up to 16 HART devices. HART devices are continuously polled and variable information is accumulated into a table of Modbus registers. Using the InLink Evaluation Board serial port, the registers can be read using Modbus RTU command 3. Variable data can be read as 16 bit integers or 32 bit floating point. Up to 4 variables for each polled HART device.

In the accumulate mode, InLink-HM will function as a HART master (primary or secondary) polling devices and storing variable values into registers. No additional HART software is needed. The HART loop may contain a single device or up to 16 devices. When more than one device is in the loop each HART device must have a unique HART polling address. The address for each device is set before wiring the device into the multi-drop loop. The device polling address for each device is stored in the InLink-HM using the HM Configuration Software.

Modbus slave address, baud rate, parity, and other settings are set using the HM Configuration Software. Configuration is done using the same port that Modbus will use so no additional setup cable is required. After the configuration is completed, the port is connected to the Modbus controller. At power on the InLink-HM will begin polling and accumulating values. Modbus RTU command 3 is used to read the accumulated values.

HM Configuration Software Installation - Windows

The HM Configuration Software is available from Microflex as a download and is shipped with MicroLink-HM products on CD. Simply insert the CD and follow the on-screen prompts to install the software. If AutoRun is not configured to run the CD file when the CD is inserted you will need to navigate to the **Msetup.exe** file on the CD and double-click the file name to run it.

After Installation the HM Configurator icon will be added to your system.

Don't have a CD drive?

Download the HART Protocol CD image from www.microflx.com/pages/support



Home Screen

The home screen displays a summary of the HM Configuration status, HART modem settings, and Modbus settings. Use the top drop-down menus to configure the InLink-HM modem.

Setup COM Port

The HM Configuration software must be set to use the same COM port that the modem is connected to. From the top menu select **Setup>Com Port**. Choose the COM port number from the list of available ports. After choosing, click **Connect** to attempt to connect using the settings selected. The connection process will first try the last good baud rate and parity settings. If it fails to connect the process will work through other settings

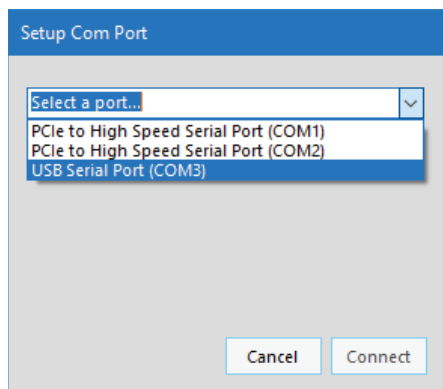

to try to find the correct InLink-HM settings for communications. If it still does not connect - verify that you have chosen the correct COM number, connections are correct, and power is on before trying again.

Figure 3. COM Port List.

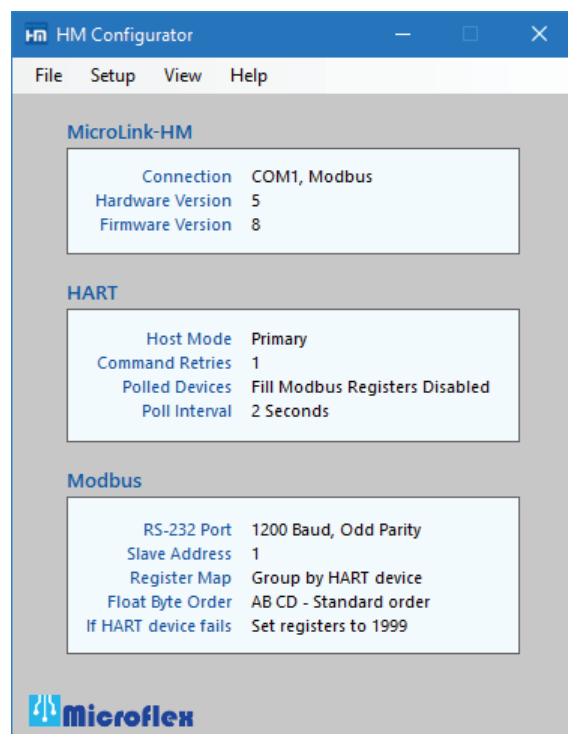
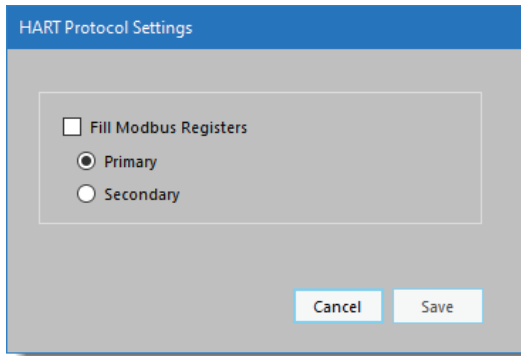

Figure 4. HM Configuration Setup home screen.

HART Protocol Settings

With **Fill Modbus Registers** unchecked, InLink-HM will function as a standard HART protocol modem and not poll HART devices to fill Modbus registers. In this mode HART packets are received and then retransmitted at the HART 1200



baud, odd parity. Received reply packets are retransmitted at the selected baud rate. RTS timing and carrier detect are handled internally by the InLink-HM allowing communications at higher than 1200 baud. HART loop data is handled at the standard HART protocol 1200 baud, odd parity but because InLink-HM buffers the data the port can be set for higher rates as well as odd, even, or no parity. Port settings can be set in the Modbus Settings section.

Since InLink-HM manages network timing it needs to be configured for either a primary or secondary master. Configuration modems are typically set to be secondary masters.

Polling HART Devices - Fill Modbus Registers

To enable Modbus register accumulation, check the **Fill Modbus Registers** option. The Hart Protocol Settings window will expand to show the Polled Devices settings.

Retries

If a HART device is polled but does not respond, or errors are detected, InLink-HM can retry up to 3 times before indicating a bad device. If a device is not responding the Modbus values are filled with Hart Device Failed register values - setup is done in the Modbus configuration section.

Polled Devices

In the example screen shot (Figure 5), InLink-HM is set to poll one HART device using polling address 0 and will retry 1 time before reporting a communications error. The **Device Variables (Modbus Register Values)** box on the right displays the register values for the active polled device. Click **Add Device** to add a polled HART device. Be sure to set the **Polling Address** for each

device. Each device must have a unique HART polling address. Polling addresses must be setup for each HART device before it can be connected to a multi-drop HART loop and can be set from 1 to 63.

Address 0 can only be used when one device is in the HART loop.

Polling addresses 16-63 should only be used with HART revisions 6 and higher. For HART 3-5 use addresses 1-15 for multi-drop systems.

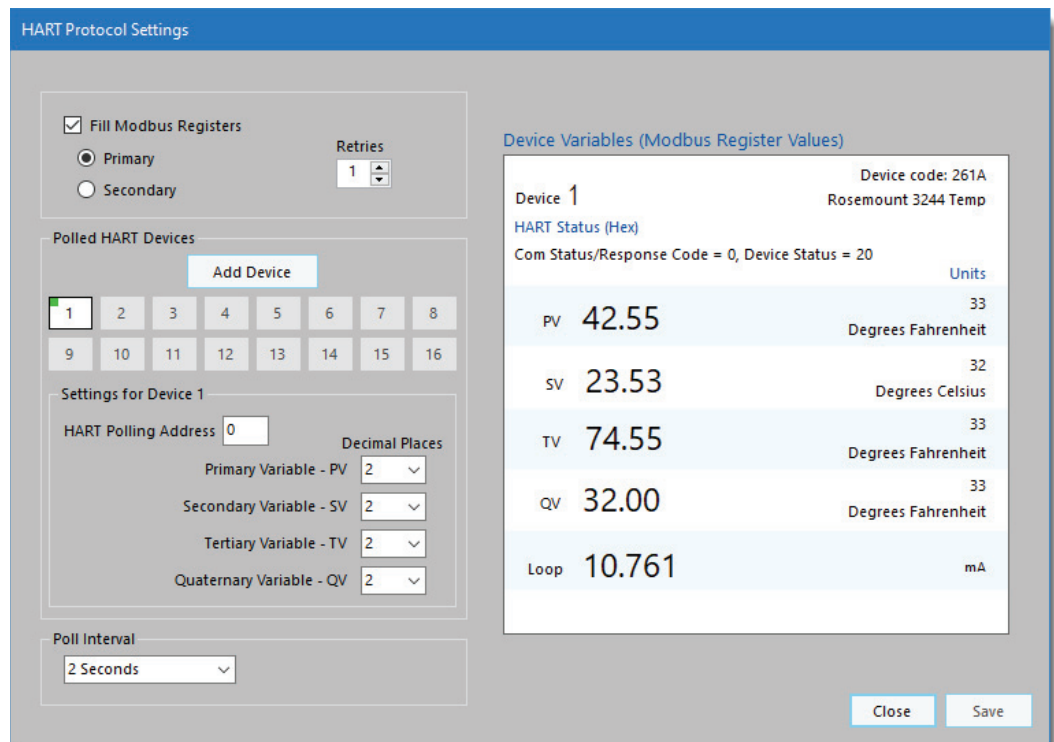

Figure 5. HART protocol settings dialog when filling modbus registers is enabled.

Decimal Places

When device data is stored into a 16 bit signed Modbus register the value can range from -32768 to 32767. To allow the 16 bit integer to represent a smaller number and include fractional information, the number of decimal places is stored in a separate Modbus register and applied later. The number of decimal places can be set from 0 to 5. Decimal places can be set for each variable. The **Device Variables** box shows the effect of the decimal place setting. Decimal place settings are not used for the Modbus floating point register values.

Modbus - RTU Setup

Modbus-RTU Settings can be accessed and changed by clicking **Setup>Modbus** from the top drop-down menu.

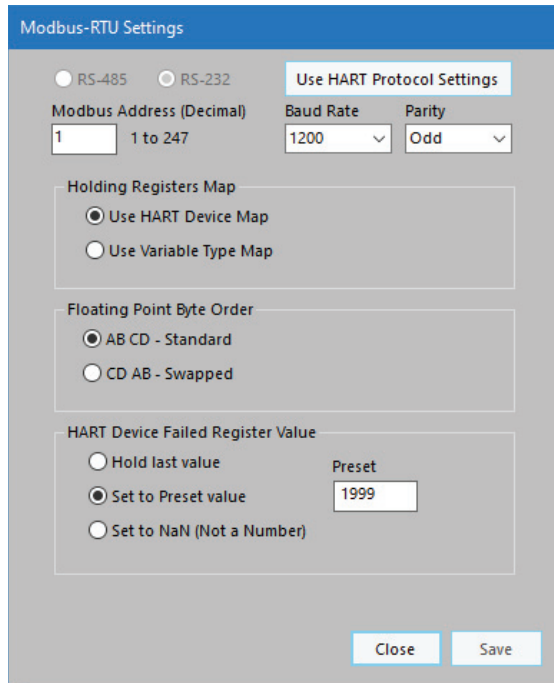

Figure 6. Modbus settings dialog.

Floating Point Byte Order

Modbus 32 bit floating point numbers are stored in two consecutive 16 bit registers using the IEEE-754 standard big endian byte order (AB-CD). The most significant byte (A) is sent first. For compatibility with some modbus systems you may need to use the word swapped format (CD-AB).

HART Device Failed Register Value

If a polled HART device fails to respond, or has communications errors it will retry for the number of times set in the HART Protocol Settings dialog. If after retries the device does not respond you can choose to hold the last value, set to a preset number, or set to the IEEE-754 NaN floating point value. This can help the modbus master determine when a HART device is no longer responding.

Restore Defaults

To restore InLink-HM to its default settings, select **Setup>Restore Defaults** from the top drop-down menu. This functionality requires HM Configurator Software 1.2.0.5 or higher.

Modbus Address

Each device on a Modbus network must have a unique address. Set this to match the address that your Modbus master will use to communicate with the InLink-HM. The Modbus address can be set to any value from 1 to 247. The HM Configuration software will discover this address as part of the connection process.

Baud Rate & Parity

The InLink-HM baud rate and parity must be set to the same settings as your Modbus master. If you are using the InLink-HM as a HART protocol modem these should be set to 1200 baud, odd parity. Click **Use HART Protocol Settings** to set the correct values for a HART modem.

Holding Registers Map

Accumulated data is stored in Modbus registers that are grouped or mapped by HART device or by variable type. Choose the register map that best fits your application. Register maps can be viewed using the HM Configuration software. From the top drop-down menu select **View -> Modbus Registers Maps** (Figure 7.)

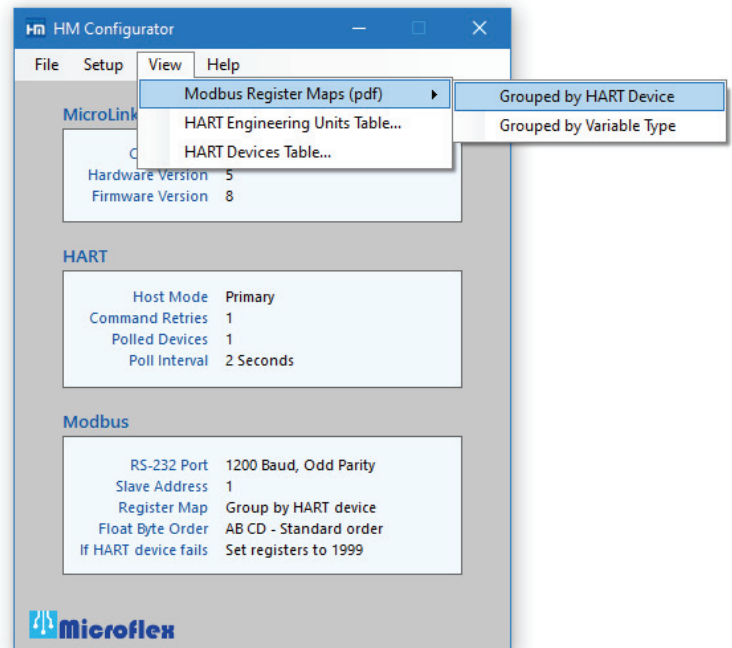

Figure 7. Menu for viewing modbus register maps.

Setup Registers

The InLink-HM configuration can be changed using the setup and configuration software or by writing to modbus registers using modbus-RTU commands 6 or 16. Command 6 writes to a single register and command 16 writes to a range of modbus registers. The configuration register values are saved in nonvolatile memory and are not lost when InLink-HM power is removed.

Modbus Register	Description (high byte, low byte)
772	HART Failed Code Preset Value
773	HART Mode Settings
774	Modbus Settings
775	Modbus Port Settings
776	Hardware Rev, Software Rev
777	Polled device status

HART Settings

773 - HART Settings

15	14	13	12	11	10	9	8	7	6	5	4	3	2	1	0
						HART Failed Mode (Bit 1)	HART Failed Mode (Bit 0)	HART Retries (Bit 1)	HART Retries (Bit 0)	0=Fill Registers, 1=HART Modem	1=Primary, 0=Secondary Master	Number of polled devices - 1 0 = 1 Polled Device (0 to 15)			

Bits 9, 8 HART failed mode.

0 = Hold last value after HART retries
 1 = Preset to register 772 value after HART retries
 2 = Preset to IEEE-754 NaN (0 for integers)

Bits 7, 6 HART poll retries.

Sets number of HART device poll retries from 1 to 3. After poll retries, the HART failed mode value is stored in the variable register.

Bits 3 - 0 Number of polled devices - 1 Range is 0 to 15. 0 = 1 polled device. 15 = 16 polled devices.

Polled HART Devices Long Address Table

Device ID information is read from each polled device using the devices polling address and HART command 0. The reply to command 0 for each polled device is used to populate the long address table. When InLink-HM needs to poll for the device variables, using HART command 3, this table holds the information needed to build the 5-byte long address. Table values can be read using modbus-RTU command 3. Only the polled device you have configured will contain valid information. The table is updated after each valid device poll.

HART Device	Modbus Register	Description (high byte, low byte)
1	700	Preambles, Man. Code or Type
	701	Device Type, ID 1
	702	ID 2, ID3
2	703	Preambles, Man. Code or Type
	704	Device Type, ID 1
	705	ID 2, ID3
3	706	Preambles, Man. Code or Type
	707	Device Type, ID 1
	708	ID 2, ID3
4	709	Preambles, Man. Code or Type
	710	Device Type, ID 1
	711	ID 2, ID3
5	712	Preambles, Man. Code or Type
	713	Device Type, ID 1
	714	ID 2, ID3
6	715	Preambles, Man. Code or Type
	716	Device Type, ID 1
	717	ID 2, ID3
7	718	Preambles, Man. Code or Type
	719	Device Type, ID 1
	720	ID 2, ID3
8	721	Preambles, Man. Code or Type
	722	Device Type, ID 1
	723	ID 2, ID3
9	724	Preambles, Man. Code or Type
	725	Device Type, ID 1
	726	ID 2, ID3
10	727	Preambles, Man. Code or Type
	728	Device Type, ID 1
	729	ID 2, ID3
11	730	Preambles, Man. Code or Type
	731	Device Type, ID 1
	732	ID 2, ID3
12	733	Preambles, Man. Code or Type
	734	Device Type, ID 1
	735	ID 2, ID3
13	736	Preambles, Man. Code or Type
	737	Device Type, ID 1
	738	ID 2, ID3
14	739	Preambles, Man. Code or Type
	740	Device Type, ID 1
	741	ID 2, ID3
15	742	Preambles, Man. Code or Type
	743	Device Type, ID 1
	744	ID 2, ID3
16	745	Preambles, Man. Code or Type
	746	Device Type, ID 1
	747	ID 2, ID3

HART Device Polling Address Table

The polling address for each polled device is stored in this table. Two polling addresses in each 16 bit register. If address 0 is used then only one device can be polled and Device 1 should be set to 0. Address 0 is not valid in multi-drop systems. For HART devices with HART revision 3 through 5 you should use polling addresses 1 - 15. Addresses 16-63 require HART revision 6 or higher.

Modbus Register	HART Device Polling Address (high byte, low byte)
748	Device 1, Device 2
749	Device 3, Device 4
750	Device 5, Device 6
751	Device 7, Device 8
752	Device 9, Device 10
753	Device 11, Device 12
754	Device 13, Device 14
755	Device 15, Device 16

Number of Decimal Places Table

When storing the HART variable data in 16-bit modbus registers the maximum range is -32768 to 32767. To increase the possible resolution, the variable value read from the HART device is decimal position adjusted before being saved in the 16-bit register. When the register is read, the value must be corrected by the number of decimal placed to produce the correct value. The number of decimal places for each variable occupies 4-bits in the register with one register for each polled device.

Decimals	Variable Range
0	-32768 to 32767
1	-3276.8 to 3276.7
2	-327.68 to 327.67
3	-32.768 to 32.767
4	-3.2768 to 3.2767
5	-0.32768 to 0.32767

HART Device	Modbus Register	Number of Decimal Places Description (high byte, low byte)
1	756	PV-SC, TV-FV
2	757	PV-SC, TV-FV
3	758	PV-SC, TV-FV
4	759	PV-SC, TV-FV
5	760	PV-SC, TV-FV
6	761	PV-SC, TV-FV
7	762	PV-SC, TV-FV
8	763	PV-SC, TV-FV
9	764	PV-SC, TV-FV
10	765	PV-SC, TV-FV
11	766	PV-SC, TV-FV
12	767	PV-SC, TV-FV
13	768	PV-SC, TV-FV
14	769	PV-SC, TV-FV
15	770	PV-SC, TV-FV
16	771	PV-SC, TV-FV

Modbus Register Map - Grouped by HART Device (1 of 3)

Register	Description
7	Loop Current Integer
254, 255	Loop Current Float

Device 1

Register	Description
0	PV Integer
1	SV Integer
2	TV Integer
3	FV Integer
4	HART Status
5	MSB = PV UOM, LSB = SV UOM
6	MSB = TV UOM, LSB = FV UOM
256, 257	PV Float
258, 259	SV Float
260, 261	TV Float
262, 263	FV Float

Device 4

Register	Description
24	PV Integer
25	SV Integer
26	TV Integer
27	FV Integer
28	HART Status
29	MSB = PV UOM, LSB = SV UOM
30	MSB = TV UOM, LSB = FV UOM
280, 281	PV Float
282, 283	SV Float
284, 285	TV Float
286, 287	FV Float

Device 2

8	PV Integer
9	SV Integer
10	TV Integer
11	FV Integer
12	HART Status
13	MSB = PV UOM, LSB = SV UOM
14	MSB = TV UOM, LSB = FV UOM
264, 265	PV Float
266, 267	SV Float
268, 269	TV Float
270, 271	FV Float

Device 5

32	PV Integer
33	SV Integer
34	TV Integer
35	FV Integer
36	HART Status
37	MSB = PV UOM, LSB = SV UOM
38	MSB = TV UOM, LSB = FV UOM
288, 289	PV Float
290, 291	SV Float
292, 293	TV Float
294, 295	FV Float

Device 3

16	PV Integer
17	SV Integer
18	TV Integer
19	FV Integer
20	HART Status
21	MSB = PV UOM, LSB = SV UOM
22	MSB = TV UOM, LSB = FV UOM
272, 273	PV Float
274, 275	SV Float
276, 277	TV Float
278, 279	FV Float

Device 6

40	PV Integer
41	SV Integer
42	TV Integer
43	FV Integer
44	HART Status
45	MSB = PV UOM, LSB = SV UOM
46	MSB = TV UOM, LSB = FV UOM
296, 297	PV Float
298, 299	SV Float
300, 301	TV Float
302, 303	FV Float

Modbus Register Map - Grouped by HART Device (2 of 3)

Device 7

Register	Description
48	PV Integer
49	SV Integer
50	TV Integer
51	FV Integer
52	HART Status
53	MSB = PV UOM, LSB = SV UOM
54	MSB = TV UOM, LSB = FV UOM
304, 305	PV Float
306, 307	SV Float
308, 309	TV Float
310, 311	FV Float

Device 10

Register	Description
72	PV Integer
73	SV Integer
74	TV Integer
75	FV Integer
76	HART Status
77	MSB = PV UOM, LSB = SV UOM
78	MSB = TV UOM, LSB = FV UOM
328, 329	PV Float
330, 331	SV Float
332, 333	TV Float
334, 335	FV Float

Device 8

56	PV Integer
57	SV Integer
58	TV Integer
59	FV Integer
60	HART Status
61	MSB = PV UOM, LSB = SV UOM
62	MSB = TV UOM, LSB = FV UOM
312, 313	PV Float
314, 315	SV Float
316, 317	TV Float
318, 319	FV Float

Device 11

80	PV Integer
81	SV Integer
82	TV Integer
83	FV Integer
84	HART Status
85	MSB = PV UOM, LSB = SV UOM
86	MSB = TV UOM, LSB = FV UOM
336, 337	PV Float
338, 339	SV Float
340, 341	TV Float
342, 343	FV Float

Device 9

64	PV Integer
65	SV Integer
66	TV Integer
67	FV Integer
68	HART Status
69	MSB = PV UOM, LSB = SV UOM
70	MSB = TV UOM, LSB = FV UOM
320, 321	PV Float
322, 323	SV Float
324, 325	TV Float
326, 327	FV Float

Device 12

88	PV Integer
89	SV Integer
90	TV Integer
91	FV Integer
92	HART Status
93	MSB = PV UOM, LSB = SV UOM
94	MSB = TV UOM, LSB = FV UOM
344, 345	PV Float
346, 347	SV Float
348, 349	TV Float
350, 351	FV Float

Modbus Register Map - Grouped by HART Device (3 of 3)

Device 13

Register	Description
96	PV Integer
97	SV Integer
98	TV Integer
99	FV Integer
100	HART Status
101	MSB = PV UOM, LSB = SV UOM
102	MSB = TV UOM, LSB = FV UOM
352, 353	PV Float
354, 355	SV Float
356, 357	TV Float
358, 359	FV Float

Device 15

Register	Description
112	PV Integer
113	SV Integer
114	TV Integer
115	FV Integer
116	HART Status
117	MSB = PV UOM, LSB = SV UOM
118	MSB = TV UOM, LSB = FV UOM
368, 369	PV Float
370, 371	SV Float
372, 373	TV Float
374, 375	FV Float

Device 14

104	PV Integer
105	SV Integer
106	TV Integer
107	FV Integer
108	HART Status
109	MSB = PV UOM, LSB = SV UOM
110	MSB = TV UOM, LSB = FV UOM
360, 361	PV Float
362, 363	SV Float
364, 365	TV Float
366, 367	FV Float

Device 16

120	PV Integer
121	SV Integer
122	TV Integer
123	FV Integer
124	HART Status
125	MSB = PV UOM, LSB = SV UOM
126	MSB = TV UOM, LSB = FV UOM
376, 377	PV Float
378, 379	SV Float
380, 381	TV Float
382, 383	FV Float

Modbus Register Map - Grouped by Variable Type

Rev 1

Loop Current - Integer	112
Loop Current - Float	254, 255

HART Device	16-bit Signed Registers				16-bit Unsigned		
	PV Integer	SV Integer	TV Integer	FV Integer	HART Status	UOM PV, SV	UOM TV, FV
1	0	16	32	48	64	80	96
2	1	17	33	49	65	81	97
3	2	18	34	50	66	82	98
4	3	19	35	51	67	83	99
5	4	20	36	52	68	84	100
6	5	21	37	53	69	85	101
7	6	22	38	54	70	86	102
8	7	23	39	55	71	87	103
9	8	24	40	56	72	88	104
10	9	25	41	57	73	89	105
11	10	26	42	58	74	90	106
12	11	27	43	59	75	91	107
13	12	28	44	60	76	92	108
14	13	29	45	61	77	93	109
15	14	30	46	62	78	94	110
16	15	31	47	63	79	95	111

HART Device	32-bit Float Registers			
	PV Float	SV Float	TV Float	QV Float
1	256, 257	288, 289	320, 321	352, 353
2	258, 259	290, 291	322, 323	354, 355
3	260, 261	292, 293	324, 325	356, 357
4	262, 263	294, 295	326, 327	358, 359
5	264, 265	296, 297	328, 329	360, 361
6	266, 267	298, 299	330, 331	362, 363
7	268, 269	300, 301	332, 333	364, 365
8	270, 271	302, 303	334, 335	366, 367
9	272, 273	304, 305	336, 337	368, 369
10	274, 275	306, 307	338, 339	370, 371
11	276, 277	308, 309	340, 341	372, 373
12	278, 279	310, 311	342, 343	374, 375
13	280, 281	312, 313	344, 345	376, 377
14	282, 283	314, 315	346, 347	378, 379
15	284, 285	316, 317	348, 349	380, 381
16	286, 287	318, 319	350, 351	382, 383

Safety Considerations

FC Conformity in accordance with Part 2, and Part 15, Subparts A and B of the Federal Communications Rules and Regulations, and ICES-003 of the Industry Canada standards.

 This device complies with part 15 of the FCC rules. Operation is subject to the following two conditions: (1) This device may not cause harmful interference, and (2) this device must accept any interference received, including interference that may cause undesired operation. Changes or modifications not expressly approved by Microflex could void the user's authority to operate this equipment.

CE Emissions EN55022: 1998
Electrostatic Discharge EN61000-4-2: 1995, A1: 1998, A2: 2001
Radiated Immunity EN 61000-4-3: 2002
Safety Compliance EN 60950-1: 2002

 This device does not have protection from over-voltages which may exist on RS-232 ports of computers and relies on the protection existing in a host computer.

 This device is not intended for connection to the phone line through the appropriate converters and shall not be connected to telecommunication lines because it has no protection against over-voltages which may exist in these lines.

 The user shall ensure the protection of the operator from access to areas with hazardous voltages or hazardous energy in their equipment.

 The user shall ensure that the connection port of the field device and the modem is separated at least by basic insulation from any primary circuit existing in the field device.

Limited Warranty

Microflex, LLC warrants this unit against defects in materials and workmanship for a period of one year from the date of shipment. Microflex, LLC will, at its option, repair or replace equipment that proves to be defective during the warranty period. This warranty includes parts and labor.

A Return Materials Authorization (RMA) number must be obtained from the factory and clearly marked on the outside of the package before equipment will be accepted for warranty work.

Microflex, LLC believes that the information in this manual is accurate. In the event that a typographical or technical error exist, Microflex, LLC reserves the right to make changes without prior notice to holders of this edition. The reader should consult Microflex, LLC if any errors are suspected. In no event should Microflex, LLC be liable for any damages arising out of or related to this document or the information contained in it.

EXCEPT AS SPECIFIED HEREIN, MICROFLEX, LLC MAKES NO WARRANTIES OR MERCHANTABILITY OR FITNESS FOR A PARTICULAR PURPOSE. CUSTOMER'S RIGHT TO RECOVER DAMAGES CAUSED BY FAULT OR NEGLIGENCE ON THE PART OF MICROFLEX SHALL BE LIMITED TO THE AMOUNT THEREFORE PAID BY THE CUSTOMER. MICROFLEX, LLC WILL NOT BE LIABLE FOR DAMAGES RESULTING FROM LOSS OF DATA, PROFITS, USE OF PRODUCTS, OR INCIDENTAL OR CONSEQUENTIAL DAMAGES, EVEN IF ADVISED OF THE POSSIBILITIES THEREOF. This limitation of the liability of Microflex, LLC will apply regardless of the form of action, whether in contract or tort, including negligence. Any action against Microflex, LLC must be brought within one year after the cause of action accrues. The warranty provided herein does not cover damages, defects, malfunctions, or service failures caused by owners failure to follow Microflex, LLC's installation, operation, or maintenance instructions; owners modification of the product; owner's abuse, misuse, or negligent acts; and power failure or surges, fire, flood, accident, actions of third parties, or other events outside reasonable control.

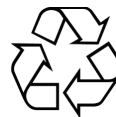

Microflex, LLC
35900 Royal Road
Pattison, Texas 77423
USA

Phone 281-855-9639
Fax 832-422-4391
www.microflx.com

