

# 1500mm UNDERMOUNT RANGEHOOD

## SL920 FRESCO 1500

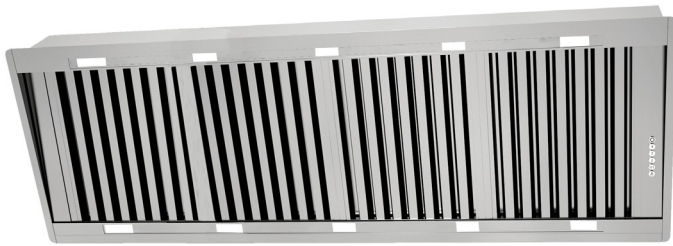

Rangehood type	Alfresco/Undermount/Island
Control	Button
Speed settings	4
Ducting diameter	300mm or 3 x 150mm
Extraction type	Onboard motor
Motor	Triple aluminium motor
Extraction	3000m <sup>3</sup> /h
Filter	25mm stainless steel baffle
Lighting	10 x 2.5W LED lights
Induction Countdown Control	Yes
Electrical requirement	10A
Dimensions (mm)	W1500 x D530 x H335
Warranty	3 years (6 years when Sirius ducting is used)

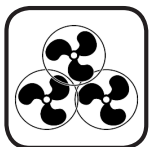

**TRIPLE ONBOARD MOTOR**



**25mm STAINLESS STEEL FILTERS**



**INDUCTION SAFE**

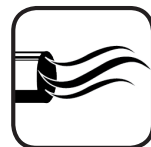

**3000m<sup>3</sup>/h AIRFLOW**



**10 x 2.5W LED LIGHTS**



**HANDCRAFTED IN ITALY**

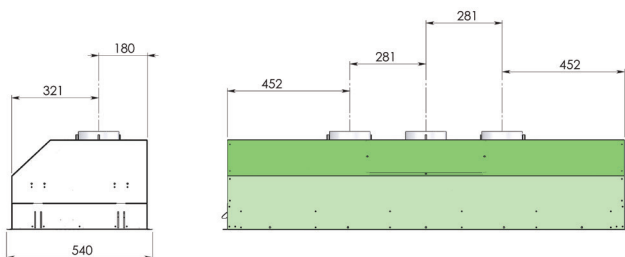
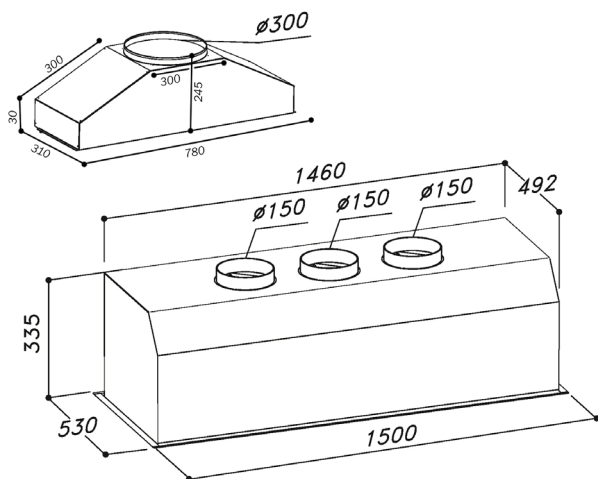

### Ducting options

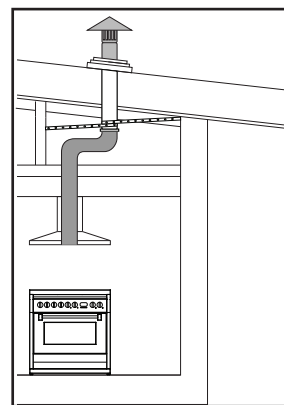

Roof ducted

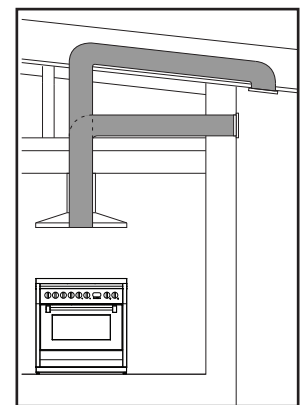

Eave or Wall ducted

- Use semi-rigid or rigid ducting, not fully flexible foil ducting.
- Fewer bends means a quieter and more powerful extraction.
- Extra 3 years warranty when Sirius ducting is used (total 6 years).
- See [support page](#) on Sirius website for installation videos and FAQs.

WARNING: technical specifications and product sizes can be varied by the manufacturer, without notice. Cut outs for appliances should only be by physical product measurements. The above information is indicative only.

Distributed by Arisit Pty Ltd