

850mm ONBOARD UNDERMOUNT RANGEHOOD

SM924 850



Rangehood type	Undermount
Control	Buttons
Speed settings	4
Ducting diameter	150mm
Extraction type	Onboard motor
Motor	Single Motor
Extraction	800m ³ /h
Filter	Aluminium filter
Noise	45dB (min) to 70dB (max)
Lighting	2 x spot lights
Induction Countdown Control	No
Electrical requirement	10A
Dimensions (mm)	W850 x D290 x H270
Cut-out dimensions (mm)	W835 x D265
Warranty	3 years (6 years when Sirius ducting is used)



SINGLE MOTOR

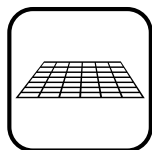

ALUMINIUM FILTERS



800m³/h AIRFLOW

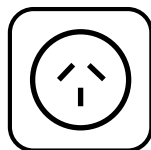

10AMP GPO REQUIRED



2 x SPOT LIGHTS



HANDCRAFTED IN ITALY

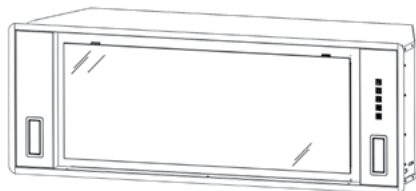
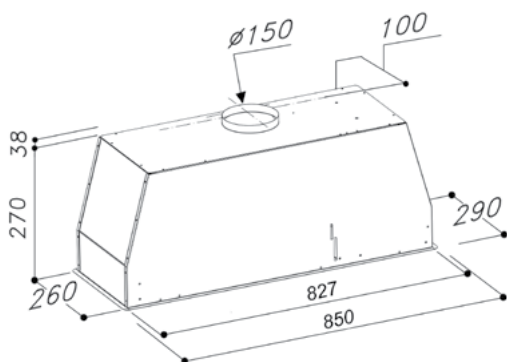

Underside view

*Product dimension includes trim

Note: Need to allow 5mm extra for ease of installation

Ducting options

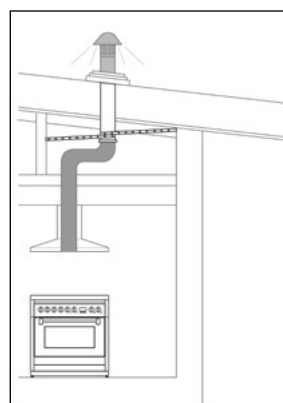

Roof ducted

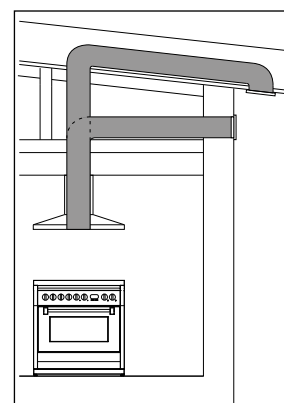

Eave or Wall ducted

- Use semi-rigid or rigid ducting, not fully flexible foil ducting.
- Fewer bends means a quieter and more powerful extraction.
- Extra 3 years warranty when Sirius ducting is used (total 6 years).
- See [support page](#) on Sirius website for installation videos and FAQs.

WARNING: technical specifications and product sizes can be varied by the manufacturer, without notice. Cut outs for appliances should only be by physical product measurements. The above information is indicative only.

Distributed by Arisit Pty Ltd

40-50 Mark Anthony Drive, Dandenong South VIC 3175

Ph: 1300 762 219

Fax: 03 9768 0838

Website: www.arisit.com

www.siriusbrand.com