



TABLE OF CONTENTS

01. Technical Specifications	2
02. Anatomy of Your Airbrush	3
03. General Information	4
3.1 Compressors & Air Pressures	4
3.2 Paint Preparation	4
3.3 Airbrush System Setup	4
04. General Operation	5
4.1 Before Each Use	5
4.2 Holding Your Airbrush	5
4.3 Quick-Fit™ Needle Caps	5
4.4 Installing Paint Reservoirs	6
4.5 Airbrush Trigger Operation	7
4.6 Spray Pattern Adjustments	7
4.7 Pre-set Knob Adjustments	8
05. Maintenance	9
5.1 Cleaning your Airbrush	9
5.2 Cleaning Between Color Changes	10
5.3 After Each Use	10
5.4 Airbrush Back Flushing	11
5.5 Needle Pumping	12
5.6 Airbrush Straight Flushing	12
5.7 Cleaning Paint Reservoirs	12
5.8 Cleaning the Fluid Nozzle	13
5.9 Airbrush Lubrication	13
06. Nozzle Conversion Kits	14
07. Replacement Parts	15
08. Accessories	16
09. Private Stock™ Color System	18
10. Troubleshooting Guide	19
11. Exploded Diagrams	20
12. Warranty Information	22

Congratulations on your purchase of a GreX airbrush. GreX Tritium airbrushes represent our premium line of double action pistol style trigger airbrushes. Its intuitive easy-to-use design appeals to beginners, but its fine detail control and comfortable operation makes it appealing to professionals as well. Tritium airbrushes are a comprehensive, feature-rich line that can accommodate to your airbrushing preferences and you'll find the same reliable, high performance you'd expect from any GreX product. Thank you for choosing GreX and for joining us on this journey for ...

the Evolution of Perfection ®

- * *Recommended Operating Pressures: 4 ~ 80psi (0.28 ~ 5.52bar)*
- * *Operating pressures may vary depending on paint used.*
- * *All optional accessories are sold separately.*
- * *See Section 8 for a full list of available genuine GreX accessories.*



1. TECHNICAL SPECIFICATIONS

Tritium.TG

Airbrush Type Double Action Pistol Style Trigger
 Feed Type Top Gravity
 Weight 180g (6.4 oz.)
 Length 159mm (6.25")
 Included Fluid Reservoirs 2mL (1/20 fl. oz.) Top Cup w/ Lid
 7mL (1/4 fl. oz.) Top Cup w/ Lid
 15mL (1/2 fl. oz.) Top Cup w/ Lid
 Kit includes Quick-Fit™ Needle Cap
 Quick-Fit™ Crown Cap
 Nozzle Wrench
 Optional Accessories 50mL (1.7 fl. oz.) Top Cup w/ Lid
 125mL (4.2 fl. oz.) Top Cup w/ Lid
 G-MAC Quick Connect Valve
 TK - Nozzle Conversion Kits
 TF - Fan Spray Caps

Model No.	TG2	TG3	TG5
Fluid Nozzle	0.2mm	0.3mm	0.5mm
Min. Spray Pattern	Hairline	Hairline	Hairline
Max. Spray Pattern	20mm (3/4")	25mm (1")	50mm (2")

Tritium.TS

Airbrush Type Double Action Pistol Style Trigger
 Feed Type Side Gravity
 Weight 180g (6.4 oz.)
 Length 159mm (6.25")
 Included Fluid Reservoirs 7mL (1/4 fl. oz.) Side Cup w/ Lid
 15mL (1/2 fl. oz.) Side Cup w/ Lid
 AD32 Side Feed Adaptor w/ 30mL (1 fl. oz.) Bottle
 Kit includes Quick-Fit™ Needle Cap
 Quick-Fit™ Crown Cap
 Side Plug
 Nozzle Wrench
 Optional Accessories 50mL (1.7 fl. oz.) Side Cup w/ Lid
 125mL (4.2 fl. oz.) Side Cup w/ Lid
 G-MAC Quick Connect Valve
 AD31 - Adaptor, Grex to Iwata or Aztek Side Feed
 TK - Nozzle Conversion Kits
 TF - Fan Spray Caps

Model No.	TS2	TS3	TS5
Fluid Nozzle	0.2mm	0.3mm	0.5mm
Min. Spray Pattern	Hairline	Hairline	Hairline
Max. Spray Pattern	20mm (3/4")	25mm (1")	50mm (2")



2. ANATOMY OF YOUR AIRBRUSH

Tritium.TG

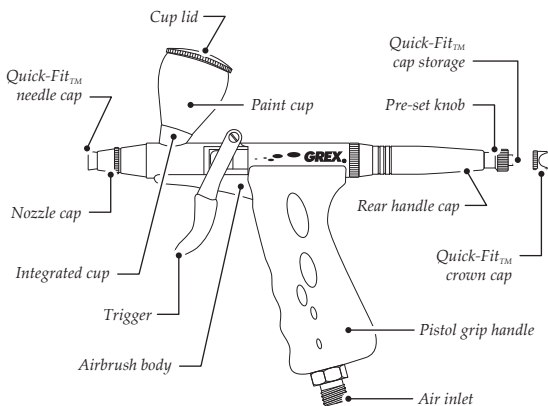

Tritium.TS

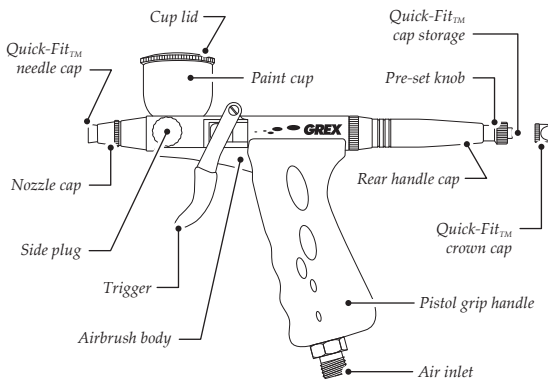

3. GENERAL INFORMATION

3.1 Compressors and Air Pressures

Choosing an appropriate air compressor that supplies sufficient air flow ensures the ability to take full advantage of the versatile spray characteristics of your GreX airbrush. Working pressures can vary from 4 to 80 psi depending on the type of work and what textures are desired. Paint viscosity and fluid nozzle opening size can affect optimal working pressures. In general, thicker and higher viscosity paints require higher pressures. Thick paints may require 45 psi or higher, while thinner paints may only need 18 to 25 psi.

It is strongly recommended that you use air filters, moisture traps, and pressure regulators as part of your airbrush system. Having clean, dry air enables optimal performance, provides hassle-free maintenance, and prolongs the life of your airbrush.

Note: Use of the siphon attachment requires relatively higher operating pressures than gravity feed cups.

3.2 Paint Preparation

Your GreX airbrush comes standard with Teflon packings which allows most paints to be used with the airbrush. This includes, but is not limited to, food dyes, acrylics, textile paints, makeup, lacquers, and urethanes.

Proper paint preparation is needed for best performance. Paint must be reduced using the proper solvent (manufacturer recommended) and mixed thoroughly. Always filter the paint through a fine nylon mesh to remove clumps and chunks that can disrupt consistent spray and block the minute passageways in the airbrush.

Warning: Always wear proper protective gear and clothing (such as goggles, respirator, dust mask and gloves). Work in a well ventilated area, especially when using urethane and enamel based paints. Follow all instructions that come with your paint, and use the reducers recommended by the paint manufacturer.

3.3 Airbrush System Setup

Attach any desired accessories, such as moisture traps, filters, regulators, etc., to your compressor and/or airbrush depending on your setup. Connect an air hose between the compressor and airbrush while using the appropriate adapters where necessary. Refer to Section 8 "Accessories" to learn more about adapters that may be needed for your system setup. Adjust air pressures according to paint type and desired spray characteristics. Check for any air leaks from the compressor and air hose. Then fill the paint reservoirs or bottles with paint when ready to use.

4. GENERAL OPERATION

4.1 Before Each Use

Spray water or appropriate paint solvent through your airbrush to make sure the airbrush is working properly and to clear out any pigment residue present. Refer to Section 4.5 "Airbrush Trigger Operation" for specific instructions on airbrush operation.

4.2 Holding Your Airbrush

There are several options to holding your airbrush for operation. In the following few figures, we illustrate some of the recommended methods. Choose the one that allows you to work most naturally and comfortably.

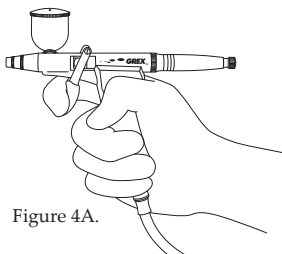

Figure 4A.

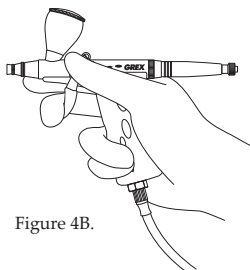

Figure 4B.

4.3 Quick-Fit™ Needle Caps

All GreX Tritium airbrushes feature our patented Quick-Fit™ needle caps. These caps can be easily removed and installed by simply attaching them to the magnetic nozzle cap. Each airbrush includes one Quick-Fit™ Standard Needle Cap and one Quick-Fit™ Crown Needle Cap. Both caps are meant to protect the needle tip from damage, but the crown needle cap is cut away on two opposite sides to allow spraying of fine lines with the airbrush positioned close to the work surface.

Note: The rear end of the Pre-set Adjustment Knob also serves as a convenient magnetic storage for either Quick-Fit™ needle caps.

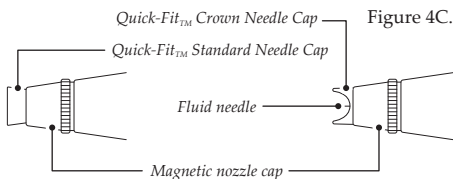
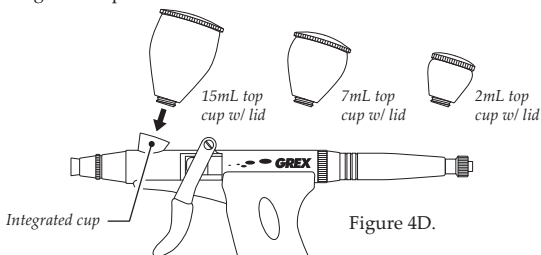

Figure 4C.

4.4 Installing Paint Reservoirs

Tritium.TG

Your Tritium.TG airbrush comes with three top gravity cups of varying fluid capacity. Depending on your application, you can chose to install either one of these cups. Simply securely screw the threaded base of the cup onto the airbrush. For very minute amounts of paint, you can forgo the paint cups and just use the integrated cup.



Tritium.TS

Your Tritium.TS airbrush comes with three reservoirs of varying fluid capacity - two side gravity cups and one side siphon attachment with bottle. Depending on your application, you can choose to install either one of these reservoirs and they can be installed on either the left or right hand side of the airbrush. Side reservoirs can also be adjusted to be used at any angle.

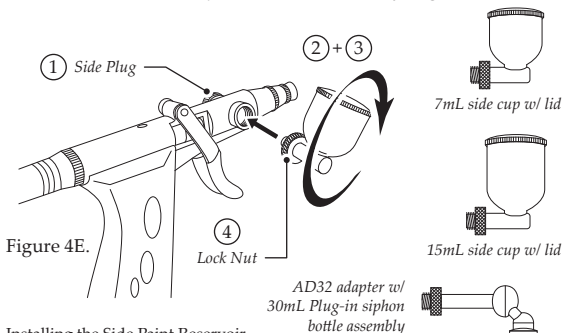

Installing the Side Paint Reservoir

1. Screw in Side Plug on the opposite side you'd like to install reservoir
2. On other side of airbrush, screw in reservoir as much as possible
3. Turn the reservoir to the desired position
4. Tighten the lock nut to secure the reservoir position

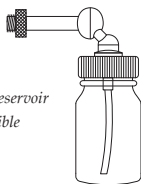

4.5 Airbrush Trigger Operation

In a double action pistol style trigger airbrush, the trigger controls *both* the air flow through the airbrush and the paint volume sprayed. Pulling the trigger back to the halfway point opens the air valve at the bottom of the airbrush and allows air to flow through. Further pulling back on the trigger pulls the fluid needle back away from the fluid nozzle allowing paint to be sprayed. As the trigger continues to be pulled back, the nozzle opening becomes larger which allows more paint to be sprayed to create a wider spray pattern.

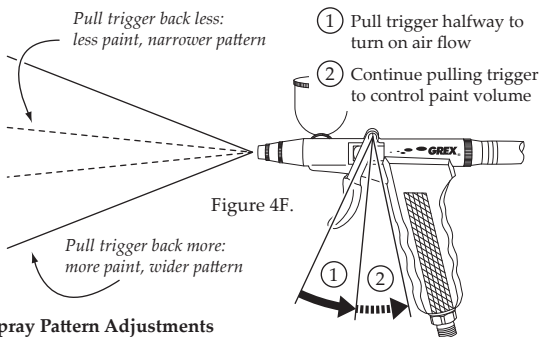

Figure 4F.

4.6 Spray Pattern Adjustments

Paint sprayed from an airbrush exits from the nozzle in the form of a cone. As the needle of the airbrush is pulled back away from the nozzle, the nozzle opening is increased allowing more paint to be sprayed resulting in a wider cone. Depending on where the work surface intersects this cone, a different spray width is achieved. So, line widths produced by the airbrush are controlled by a combination of adjusting the distance the airbrush is held from the work surface and adjusting the amount of paint allowed to spray.

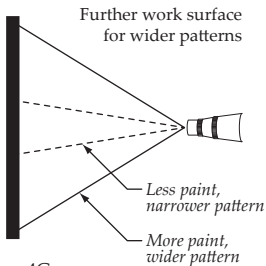

Figure 4G.

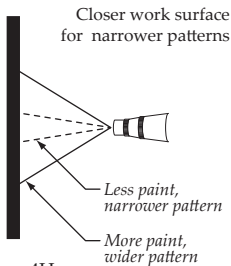

Figure 4H.



4.6 Spray Pattern Adjustments <continued>

Fine Line Spraying

To spray a fine line, position your airbrush close to your work surface and control your airbrush such that a minimal amount of paint is sprayed. The closer the airbrush is to the work surface, the finer the line that is created. An extremely fine line can be obtained by using the Crown Needle Cap and positioning your airbrush even closer to the surface. See page 7, Figure 4H for reference.

Wide Line and Background Spraying

To create wider lines and background spraying, position your airbrush further from the work surface and control the airbrush to release more paint. Increasing the air pressure, the distance of the airbrush from the surface, and the amount of paint sprayed will further increase spray widths. See page 7, Figure 4G for reference.

Stippling

Stippling is the technique of using small dots to simulate varying degrees of solidity or shading. There are many methods for creating stippling effects with an airbrush, but one way this can be achieved is by lowering the air pressure to between 5 and 15 psi and pumping the trigger. Lower air pressures will usually produce coarser stipples whereas higher air pressures will provide finer stipples. Note that paint viscosity will also affect the stippling texture.

4.7 Pre-set Knob Adjustments

To help produce constant line widths, your GreX airbrush comes standard with a Pre-Set Knob on the end of the rear handle cap. A set amount of paint is sprayed by limiting how far the trigger can be pulled back. Turning the knob clockwise reduces how far the trigger can move to help produce consistent fine lines. Turning the knob counter clockwise allows the trigger to move further back to help produce consistent wider lines. Fully turning the knob clockwise will prohibit trigger movement and prevent any spraying. Fully turning the knob counter clockwise will allow the full range of trigger action and deactivate the Pre-set knob capabilities.

5. MAINTENANCE

Your GreX airbrush is a durable precision instrument. As with any precision instrument, it is susceptible to damage if handled improperly. Take care to prevent damaging the components of this highly sensitive tool to assure peak performance throughout its lifetime. Proper maintenance of your GreX airbrush demands appropriate cleaning and requires correctly replacing and adjusting its parts. Daily and thorough maintenance of your airbrush will result in spraying that is smooth, consistent, and hassle-free.

5.1 Cleaning your Airbrush

Your airbrush needs to be cleaned between color changes, if it is not being used for an extended period of time, at the end of the work day, or if your airbrush is not performing properly. It is only necessary to clean areas of the airbrush which come in contact with paint; namely, the paint reservoir, paint passageway, nozzle, needle cap and around the tip of the needle. These areas must be kept clean for optimum performance of the airbrush.

Always empty paint out of your airbrush if not used for relatively long periods of time and spray appropriate solvent until the airbrush is flushed free of color. Blockages caused by dried paint are the biggest problem when using an airbrush. Any time the airbrush becomes clogged, first try increasing the air pressure and spray appropriate solvent through the airbrush for a short period of time. If this does not clear the clog, a thorough cleaning of the airbrush may be needed.

Caution: Never soak or submerge your entire airbrush in any solvent and/or cleaning solution to avoid damaging the o-rings and airbrush packing. More importantly, it will ensure that solvent and/or cleaning solution does not enter the air valve and damage its seals and o-rings.

Warning: Never use ammonia or ammonia based products on or in the airbrush. Ammonia will corrode the brass and chrome used to make your airbrush. Do not use abrasives (cleansers, sand paper, etc.) or metal objects to clean. They can scrape the metal finish, causing nicks, scratches, and/or destroy airbrush parts that will degrade the quality and performance of your airbrush.

Note: Always wear proper protective gear and clothing (such as goggles, respirator, dusk mask and gloves) and work in a well ventilated area, especially when using urethane and enamel based paints. Make sure to dispose of materials properly.

5.1 Cleaning the Airbrush <continued>

Note: We recommend using the mildest solvent to clean the types of paint used. If water-based paints were used, then water is usually sufficient to clean out your airbrush. Be sure to follow all instructions that come with the solvents.

Tip: Perform all your cleaning in a contained area (ie. cookie sheet, plate, bowl) to prevent parts from getting lost or damaged. It also helps keep any mess in a contained area.

5.2 Cleaning Between Color Changes

1. Empty out remaining paint in the paint reservoir and wipe off as much residual paint as possible with a paper towel. Spray out any excess paint.
2. Partially fill the paint reservoir with the appropriate solvent and use a brush to breakdown paint in the reservoir. Pour out this dirty solution.
3. Partially fill the paint reservoir again with solvent and spray the solvent at a heavy spray setting into a paper towel, waste container or similar material.
4. Repeat spraying solvent until airbrush is flushed free of color.

5.3 After Each Use

1. Follow Section 5.2 "Cleaning Between Color Changes."
2. Back flush your airbrush to clean the paint passageway. Refer to Section 5.4 "Airbrush Back Flushing."
3. Pump the needle of your airbrush to clean the internal packing. Refer to Section 5.5 "Needle Pumping."
4. Straight flush your airbrush to clean the paint passageway. Refer to Section 5.6 "Airbrush Straight Flushing."
5. Carefully remove fluid needle from your airbrush and set aside.
6. Thoroughly clean paint reservoirs and external passageways. Refer to Section 5.7 "Cleaning Paint Reservoirs."
7. Thoroughly clean threads on airbrush and reservoirs.
8. Carefully remove and clean needle and nozzle caps.
9. Clean the fluid needle and carefully re-insert into your airbrush. Refer to Section 5.8 "Cleaning the Fluid Needle."

5.3 After Each Use <continued>

10. Clean the rest of the airbrush body and dry thoroughly.
11. Make sure the entire airbrush is re-assembled properly.
12. Spray some water or alcohol through your airbrush to make sure it has been thoroughly cleaned and is functioning properly before storing.

Note: After your airbrush parts have been removed and cleaned, they must then be carefully replaced and adjusted in their designated positions. Failure to align each part correctly will prevent your airbrush from functioning properly. In many instances, when an airbrush fails to perform correctly, these problems result from improper cleaning and/or alignment of parts.

5.4 Airbrush Back Flushing

1. Remove the rear handle cap, loosen the needle lock and retract the needle slightly back into the fluid nozzle. Retighten the needle lock.
2. Partially fill the paint reservoir with water or cleaner.
3. Using your finger or a towel, carefully block the front of the airbrush opening (needle cap). Refer to Figure 5A below.
4. Pull trigger to push air upstream into the paint reservoir to back flush (bubbles will appear in paint reservoir).
5. Hold 15 to 20 seconds. Then pour out the dirty solution.
6. Repeat back flushing until the water or cleaner in the paint reservoir remains clean.

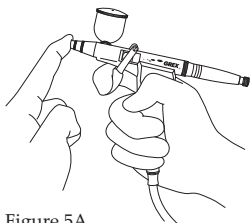

Figure 5A.

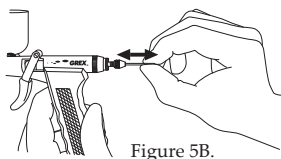

Figure 5B.

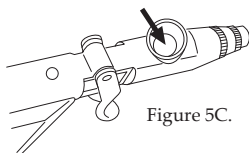

Figure 5C.

5.5 Needle Pumping

1. With rear handle cap removed, loosen the needle lock.
2. Partially fill the paint reservoir with water or cleaner.
3. Hold the needle and move it slightly in and out of your airbrush repeatedly (pumping) to clean the internal packing. Refer to Figure 5B on page 11.
4. Pour out the dirty solution.
5. Add water or cleaner to the paint reservoir and continue pumping until the solution in the paint reservoir remains clean.
6. Carefully slide needle forward into fluid nozzle. Make sure it sets firmly into the fluid nozzle. Re-tighten needle lock and replace rear handle cap.

5.6 Airbrush Straight Flushing

Partially fill the paint reservoir with water or cleaner and spray at a heavy spray setting into a paper towel, waste container or similar material. Repeat straight flushing your airbrush until the solution sprays out clean. The internal paint passageway should now be clean.

5.7 Cleaning Paint Reservoirs

Tritium.TG - Thoroughly clean the paint passageway at the bottom of the paint reservoir. Refer to Figure 5C on page 11.

Tritium.TS side cups - Remove the paint cups and thoroughly clean the paint passageway through the cup. Remove and clean the lock nut and also the threads of the cup. Thoroughly clean the opening on the side of the airbrush. Refer to Figure 5D below.

Tritium.TS AD32 side siphon adaptor - Remove the adaptor and bottle cap. Thoroughly clean the adaptor, paint passageway of the adaptor, bottle, and bottle cap, including the plastic tubing. Refer to Figure 5E below. Also thoroughly clean the side openings of the airbrush.

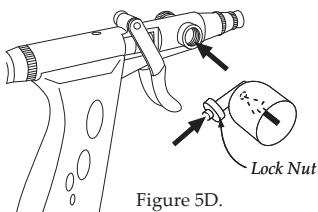

Figure 5D.

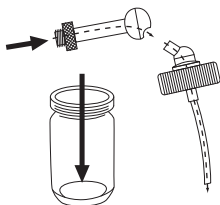

Figure 5E.

5.8 Cleaning the Fluid Needle

Wipe needle clean (start from the back end and wipe towards the needle tip). Carefully slide needle back into the airbrush, while adding a little twist to make sure it sets firmly into the fluid nozzle. Re-tighten needle lock and re-attach rear handle cap.

Before replacing the needle, you may apply a light coat of lubricant to the needle to facilitate smooth trigger motion.

5.9 Airbrush Lubrication

Caution: Do not use light machine oil, WD40 or any petroleum and silicon based products for lubrication. Doing so will cause the needle to stick as it moves through the needle packing and may contaminate the paint.

To ensure smooth operation, lubricate the needle regularly. Periodically remove the fluid needle and coat with high quality airbrush lubricant. Then wipe the needle with a soft clean cloth, leaving a light coat of lubricant.

Caution: Do not over lubricate the needle. Doing so may transfer excess lubricant into the nozzle and paint reservoir causing severe paint flow problems and paint contamination.

After a full tear down and cleaning, it is recommended to inspect the slider (#8) and shift pin (#18) to ensure they are sufficiently lubricated (refer to schematic on page 20). Use a high quality multipurpose synthetic grease (such as Super Lube). This should be applied to the o-rings and top of shift pin, as well as the under side of the slider before re-assembly. Refer to Figure 5F below.



A video demonstrating the full assembly and dis-assembly of GreX airbrushes can be found by visiting: www.greXairbrush.com/ABM

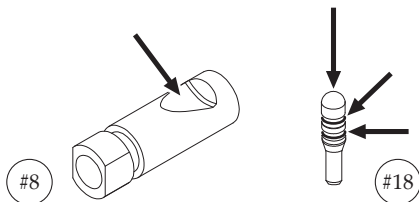
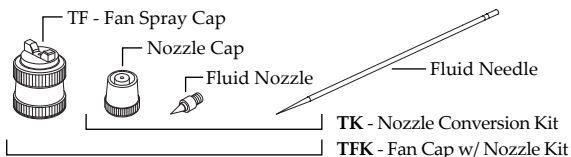

Figure 5F.

6. NOZZLE CONVERSION KITS

Nozzle Conversion Kits are great as replacement parts or an excellent way to change your spray output. Compatible with the Tritium.TS, TG, and Genesis.XGi and XSi.

Caution: Please read, understand and follow the instructions in Section 7, "Replacement Parts," before replacing or changing any part of your airbrush with the Nozzle Conversion Kits.



Size	0.2mm			0.3mm			0.5mm			0.7mm		
Item No.	TK-2	TF-3	TK-3	TFK-3	TF-5	TK-5	TFK-5	TF-7	TK-7	TFK-7		
Fan Cap		✓		✓	✓		✓	✓		✓		
Nozzle Cap	✓		✓	✓		✓	✓		✓	✓		
Fluid Needle	✓		✓	✓		✓	✓		✓	✓		
Fluid Nozzle	✓		✓	✓		✓	✓		✓	✓		

Fluid Needle Identification

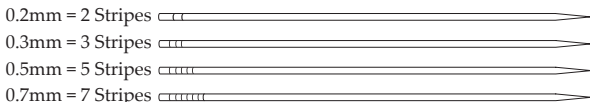

Fluid Nozzle, Nozzle Cap and Fan Spray Cap Identification

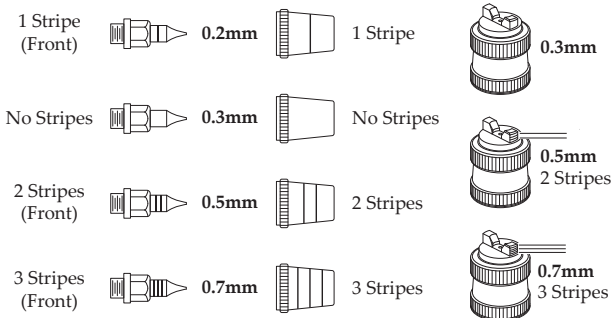

7. REPLACEMENT PARTS

Caution: If it is necessary to disassemble your airbrush: (1) DO NOT use pliers. In most cases, no tools are required to disassemble your airbrush except those provided in the kit. (2) DO NOT over tighten the fluid nozzle when assembling. Only a slight force is needed with the included nozzle wrench.

Even though GreX airbrushes are manufactured with precision machining and high quality materials, several delicate parts require replacement due to normal wear and tear. These include the fluid nozzle, fluid needle, o-rings, and needle packing.

Fluid Nozzle – Before replacing the fluid nozzle, be sure that the needle is slightly pulled back away from the fluid nozzle. To do this, remove the rear handle cap, loosen the needle lock and carefully pull the needle back. Remove the needle cap and nozzle cap then carefully unscrew the fluid nozzle using the wrench supplied with your kit. Replace with a new fluid nozzle and re-assemble the airbrush. Make sure the needle is set firmly into the fluid nozzle.

Caution: DO NOT over tighten the fluid nozzle when assembling. Only a slight force is needed with the nozzle wrench.

Note: It is recommended to change the fluid needle at the same time to ensure even wear.

Fluid Needle – GreX needles are made of precision ground and hardened stainless steel and will withstand prolonged use. However, because of their fine tip and long taper, they are easily subject to physical damage. This is a highly delicate part and any small deformations to the needle tip will compromise the performance of your airbrush. If the tip is severely bent, it must be straightened before being removed to prevent damage to the fluid nozzle.

To purchase replacement parts, contact your local GreX dealer. Find your local GreX dealer by visiting www.greXairbrush.com, emailing info@greXairbrush.com, or calling 888-4-GREXCO (447-3926).

8. ACCESSORIES

A *GreX Airbrush Grip Set*

The GreX airbrush grip is an innovative accessory for any ordinary airbrush that provides better handling, control, and comfort.

GG51 - Compatible with the Genesis.XD, XG, XN, XS, XGi and XSi.
Also compatible with other brands

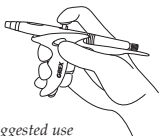

* Suggested use

**B** *Quick Connect Air Couplers and Plugs*

Quick connect couplers and plugs allow quick connect & disconnects between air hose and airbrush for easy setup and system changes.

AD02 Coupler (F) & Plug (M) Set for GreX airbrush & hose

AD03 Coupler (M) & Plug (F) Set for GreX airbrush & hose

AD09 Plug for GreX Airbrush

AD19 Plug for Badger Airbrush

AD29 Plug for Paasche Airbrush

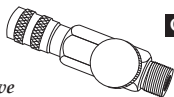
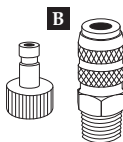
**C** *GreX Micro Air Control Quick Connect Valve*

An inline micro air control valve with a quick connect coupler for convenient air flow control at your fingertips. Perfect for precise control of stippling effects.

GMAC G-MAC w/ quick connect plug set
For GreX airbrush & hose

GMAC.B G-MAC w/ quick connect plug set
For Badger airbrush & hose

GMAC.P G-MAC w/ quick connect plug set
For Paasche airbrush & hose

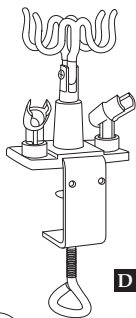
**D** *Airbrush Holder - HD1*

Adjustable to attach on table and bench tops. Holds up to 4 airbrushes with two rotatable bottom holders and two top holders that can pivot 180 deg./rotate 360 deg.

E *Side Siphon with 30mL Bottle*

CP30-01 - 30mL (1 fl. oz.)

For GreX XS, XSi, XT, TS

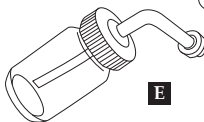

F *Bottom Siphon Assembly*

CV1-2TB (cap only)
 CP30-2 (cap *plus* 30mL glass bottle)
 For GreX Genesis.XB, XBi and AD32

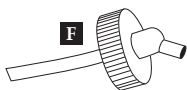
**G** *Bottom Siphon w/ 60 mL Plastic Bottle*

CP60-01
 For GreX Genesis.XB, XBi and AD32

G**H** *Side Gravity Cups*

For GreX XS, XSi, XT, TS
 CP07-02 7mL (1/4 fl. oz.)
 CP15-01 15mL (1/2 fl. oz.)
 CP50-02 50mL (1.7 fl. oz.)
 CP125-S 125mL (4.23 fl. oz.)

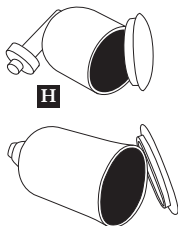
**I** *Side Feed Adapters*

For GreX XS, XSi, XT, TS
 AD31 to Iwata/Aztek side reservoirs
 AD32 to Fast Blast™ Bottles

I**J** *Top Gravity Cups*

For GreX XA, XGi, TG
 CP02-01 2mL (1/20 fl. oz.)
 CP07-01 7mL (1/4 fl. oz.)
 CP15-02 15mL (1/2 fl. oz.)
 CP50-01 50mL (1.7 fl. oz.)
 CP125-G 125mL (4.23 fl. oz.)

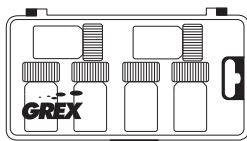
K**K** *Set of six 30mL (1 fl. oz.) Bottles*

CP30-6K
 For GreX XB, XBi, XT, TS, XSi or CP30-01, CV1-2TB

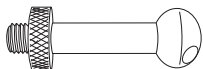
**I****L** *Air Fitting Adapters*

Connect hose, airbrush, and air fittings with different sizes.

AD05 1/8" M to 1/8" M	AD24 1/4" F to 1/4" F
AD06 1/8" F to 1/4" M	AD25 1/4" M to 1/4" M
AD10 1/4" M to 3/8" F	
AD11 1/8" F to 1/4" M	AD14 GreX airbrush to Badger hose
AD12 1/8" M to 1/4" F	AD16 Badger airbrush to GreX hose
AD20 1/8" F to 1/4" F	AD28 GreX airbrush to Paasche hose
AD21 1/8" M to 1/4" M	AD30 Paasche airbrush to GreX hose

**M** *Braided Nylon Air Hoses*

GBH-06 6' with 1/8" F x 1/8" F	GBH-30 30' with 1/8" F x 1/4" F
GBH-10 10' with 1/8" F x 1/8" F	GBH-50 50' with 1/8" F x 1/4" F
GBH-20 20' with 1/8" F x 1/8" F	

Note: 1/8" PS - Parallel Pipe Threads are standard fitting sizes used in these airbrush brands: GreX®, Harder Steenbeck®, Iwata®, Olympos®.

* Registered marks owned by their respective companies.



9. PRIVATE STOCK™ COLOR SYSTEM

Private Stock™ is a revolutionary and evolutionary paint system – made from a blend of acrylics designed and formulated for performance to give you full control on every surface imaginable.

Private Stock™ is used on all materials, ranging from illustration boards textiles, wood, leather, glass, metals and plastics that include HDPE, PVC, PET, LEXAN and Polycarbonate. Artist of every kind, Crafters, RC builders and modelers can use this single system to suit all their needs.

Private Stock™ is water-based, non-toxic and conforms to ASTM D4236 compliance standards. But unlike other water-based paints, it uses proprietary nano-technology that results in minimal dry tip issues and sprays as smooth as solvent based urethanes to ensure maximum performance and superior control, even with fine nozzle airbrushes. Its been built from the ground up specifically for airbrush use, but can also be applied with a paint brush.

Private Stock™ is only made with premium ingredients and with no fillers added whatsoever. Only pigments of the finest quality with regards to purity, strength and performance are used. All colors are extremely light fast representing the highest ratings without requiring health or precautionary labeling, which makes them more fade resistant - ideal for many outdoor applications like custom painting, textiles etc.

Private Stock™ is precision manufactured for accurate and repeatable mixing of an infinite color spectrum. This top quality color system also includes a comprehensive range of modifiers that allow you to change the properties of the paints and create a variety of special effects. Finally, a highly adjustable, yet streamlined color system that puts you in the driver seat.

- **Transparent Colors** (25 colors)
Core of the Private Stock™ System
- **Opaque Colors** (6 colors)
Useful to layout art designs
- **Fluorescent Colors** (7 colors)
Highest lightfast flourescents
- **High Solid Special FX Bases** (6 bases)
Metallics, basecoats, pearls and flakes
- **Base Modifiers** (2 bases)
Control your paint properties



10. TROUBLESHOOTING GUIDE

Symptom	Possible Causes
Paint spray skipping	<ul style="list-style-type: none">• Air pressure too high• Dirty airbrush• Paint too thick• Improper nozzle cap connection• Poor air connections to airbrush, etc.
Double line spraying	<ul style="list-style-type: none">• Bent needle• Dirty airbrush• Debris in nozzle tip or nozzle cap• Dried paint on tip of needle
Paint spraying to side	<ul style="list-style-type: none">• Bent needle• Paint build-up on side of needle cap
No or restricted spray	<ul style="list-style-type: none">• Vent hole of reservoir lid is plugged• No paint in reservoir• Clogged nozzle• Loose needle lock• Improper air pressure• Paint too thick or viscous• Cracked or damaged nozzle
Spattering spray	<ul style="list-style-type: none">• Paint too thick• Air pressure too low• Dirty airbrush• Paint build-up in needle cap• Dried paint on tip of needle• Inconsistent air source
Bubbling in paint reservoir	<ul style="list-style-type: none">• Improper fluid nozzle and body seal• Cracked or damaged fluid nozzle
Restricted trigger movement	<ul style="list-style-type: none">• Dried paint or debris in trigger area• Severely bent needle• Paint build-up on fluid needle• Paint build-up on packing seal• Pre-set knob fully tightened

11. EXPLODED DIAGRAM & PARTS LIST

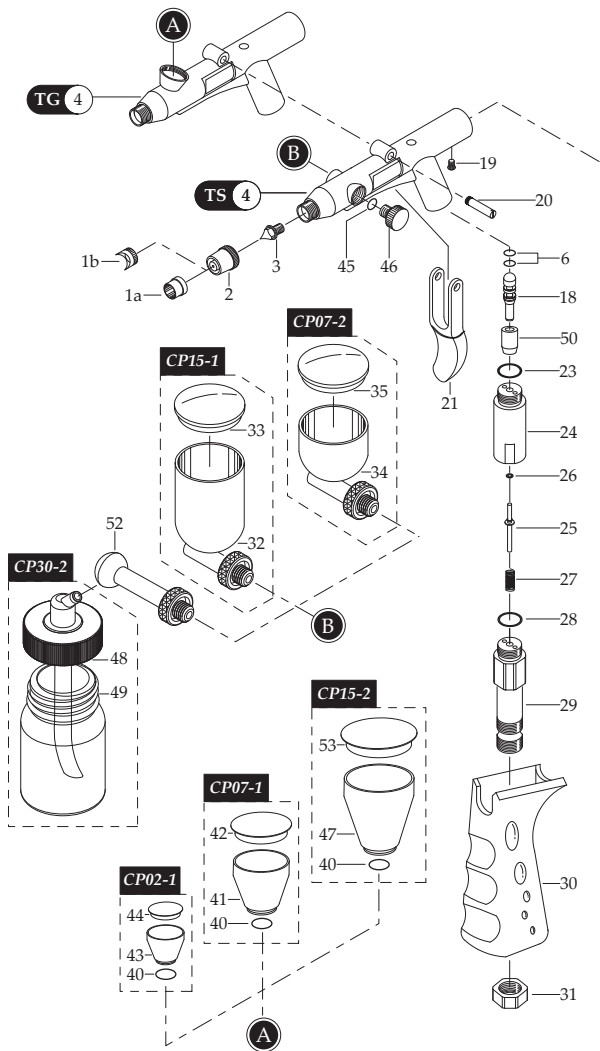

11. EXPLODED DIAGRAM & PARTS LIST

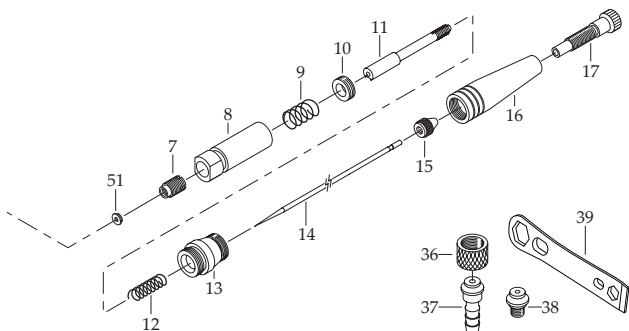

No.	Part No.	Part Description	No.	Part No.	Part Description
1a	A034000	Quick-Fit™ Needle Cap	25	A150019	Air valve pin
1b	A034010	Quick-Fit™ Crown Cap	26	A060006	O-ring
2	A044020	Nozzle cap (0.2mm)	27	A110005	Air valve spring
	A044030	Nozzle cap (0.3mm)	28	A060005	O-ring
	A044050	Nozzle cap (0.5mm)	29	A150020	Air valve extension
3	A054020	Fluid nozzle (0.2mm)	30	A150054	Pistol grip handle
	A054030	Fluid nozzle (0.3mm)	31	A150022	Nut
	A054050	Fluid nozzle (0.5mm)	32	A090003	Side gravity cup (15mL)
4	A010009	Body (TG)	33	A100003	Side cup lid (15mL)
	A010010	Body (TS)	34	A090002	Side gravity cup (7mL)
6	A060002	O-ring	35	A100002	Side cup lid (7mL)
7	A130003	Packing screw	36	A150012	Nut
8	A150013	Slider	37	A150011	Threaded insert
9	A110004	Slider spring	38	A150023	Threaded insert
10	A130007	Guide screw	39	A150027	Nozzle wrench
11	A071035	Needle chuck	40	A060008	O-ring
12	A110003	Needle chuck spring	41	A090004	Top gravity cup (7mL)
13	A150014	Slider spring casing	42	A100004	Top cup lid (7mL)
14	A024020	Fluid needle (0.2mm)	43	A090005	Top gravity cup (2mL)
	A021030	Fluid needle (0.3mm)	44	A100005	Top cup lid (2mL)
	A024050	Fluid needle (0.5mm)	45	A060011	O-ring
15	A150001	Needle lock	46	A150055	Side plug
16	A080004	Rear handle cap	47	A090006	Top gravity cup (15mL)
17	A160000	Pre-set adjustment knob	48	CV1-2TB	Bottom siphon assembly
18	A150053	Slider shift pin	49	A140001	Paint bottle (30mL)
19	A130015	Screw	50	A150056	Piston Guide
20	A130013	Trigger screw	51	A120016	Packing Seal
21	A150016	Trigger with Grip	52	AD32	Side siphon attachment
23	A060003	O-ring	53	A100009	Top cup lid (15mL)
24	A150018	Air valve assembly			

12. WARRANTY INFORMATION

All GreX airbrushes are warranted against manufacturing defects of material or workmanship for a period of SIX years from the original date of purchase. This warranty does not cover fluid needles, fluid nozzles, needle packings, and o-rings since these parts need to be replaced occasionally due to normal wear. Any parts of the product covered under this warranty will be repaired or replaced at our option, which after examination proves to be defective in workmanship or material during the warranty period. Proof of purchase may be required.

This warranty does not apply to repair or replacement parts required due to misuse, abuse, normal wear and tear or repairs and alterations attempted. In no event shall GreX be liable for any indirect, incidental, or consequential damage from the sales or use of this product. This disclaimer applies both during and after the term of this warranty.

This is the only warranty and our company makes no warranties express or implied, including merchantability and fitness for a practical purpose, after the SIX year term of this warranty. This limited warranty gives you specific rights and you may also have other rights, which vary from state to state.

All information, text and images contained in this publication are the property of GreX Airbrush. Permission is required to copy or use any text or images.

© 2019 GreX Airbrush. All Rights Reserved.

GTSM.1.33

THIS MANUAL CAN BE FOUND ONLINE AT
www.grexairbrush.com



1090 Monterey Pass Rd. Monterey Park, CA
888-4GREXCO
www.grexairbrush.com
info@grexairbrush.com