

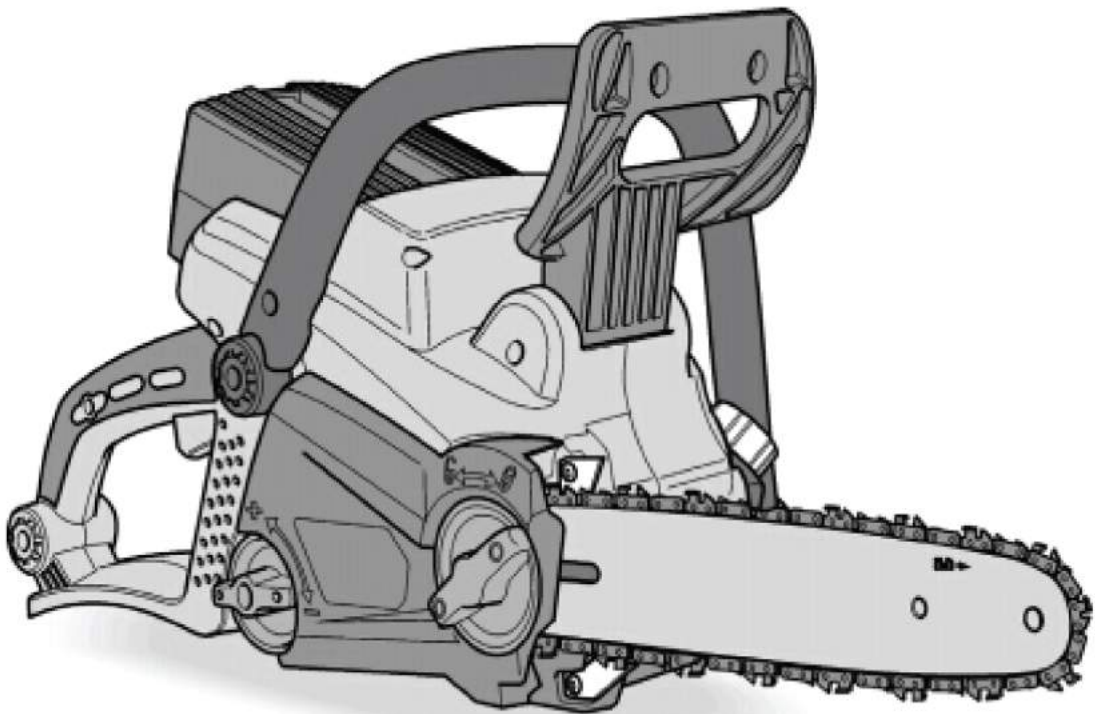

redback

40V Lithium Ion Chainsaw



MODEL E212C

Operation Manual



This safety alert symbol identifies important safety messages in this manual. Failure to follow this important safety information may result in serious injury or death.

Part # 875514



For Service or Questions

1-800-876-3009

www.redbacktools.com

email us at support@redbacktools.com

Table of Contents

Important Safety Information	
Intended Use	4
Personal Protective Equipment	4
General Safety	5
Safety Icons	6
Assembly	7
Overview of Components	10
Operation	11
Maintenance	14
Storage	15
Warranty & Specifications	16



WARNING

WARNING: Read and thoroughly understand all instructions and safety information before assembling or operating the chainsaw. Failure to do so may cause serious injury or death. Do not allow anyone to operate this chainsaw who has not read this manual. As with all power equipment, a chainsaw can be dangerous if assembled or used improperly. Do not operate this chainsaw if you have doubts or questions concerning safe operation.

Call our customer service department at **1-800-876-3009**, or visit **www.redbacktools.com** if you have any questions or concerns about the safe operation of this equipment.



DANGER

Intended Use

The chainsaw has been designed for sawing wood and felling trees, and is not suitable for sawing plastic, masonry or building materials which are not made of wood. Do not use the chainsaw for any purpose other than for which it was designed. Any other use is unauthorized and may result in serious injury or death.

Personal Protective Equipment

When operating this chainsaw it is essential that you wear safety gear including goggles or safety glasses, steel-toed shoes and tight fitting gloves (no loose cuffs or draw strings). Always wear ear plugs or sound deafening headphones to protect against hearing loss when operating this mower. Always wear sturdy footwear. Never wear sandals, sneakers or open shoes, and never operate the chainsaw with bare feet. Do not wear loose clothing that might get caught in moving parts.



General Safety

Failure to follow warnings, cautions, assembly and operation instructions in the Operation Manual may result in serious injury or death.



DANGER

READ THE OPERATION MANUAL BEFORE OPERATION.

- **Do not** permit children to operate this equipment at any time.
- **Do not** permit others that have not read and understood the complete Operation Manual to operate this equipment.
- **Keep all people and pets a minimum of 10 feet away from the work area when operating the chainsaw.**
- **Always operate the chainsaw with both hands.**
- **Do not** operate the chainsaw when under the influence of alcohol, drugs or medication.
- **Do not** allow a person who is tired, otherwise impaired or not completely alert to operate the chainsaw.



DANGER

- Do not operate the chainsaw in rain or other wet conditions. Protect the chainsaw from rain.
- Always keep hands, feet, hair and loose clothing away from the chainsaw.
- The battery should be removed before any repairs are attempted.

Battery tool use and care

- Recharge only with the charger specified by the manufacturer. A charger that is suitable for one type of battery pack may create a risk of fire when used with another battery pack.
- Use power tools only with specifically designated battery packs. Use of any other battery packs may create a risk of injury and fire.
- When battery pack is not in use, keep it away from other metal objects, like paper clips, coins, keys, nails, screws or other small metal objects, that can make a connection from one terminal to another. Shorting the battery terminals may cause burns or a fire.
- Under certain conditions, liquid may be ejected from the battery; avoid contact. If contact accidentally occurs, flush with water. If liquid contacts eyes, additionally seek medical help. Liquid ejected from the battery may cause irritation or burns.
- **DO NOT USE BATTERIES WITH DAMAGED CASES.** Dispose of batteries properly. Do not dispose of batteries in household waste.



Important Safety Information

Kickback

Kickback occurs when the tip of the guide rail touches an object or when the saw chain becomes jammed in the cut. If the rail tip touches an object, this may throw the guide rail upwards and in the direction of the operator. If the saw chain jams on the upper edge of the guide rail, the rail may quickly recoil in the direction of the operator.

Kickback can be prevented by holding the saw firmly with both hands, ensuring that your thumbs and fingers clasp the handles on the chainsaw. Move your body and arms into a position in which you can withstand the kickback force. Avoid an abnormal body posture and do not saw above shoulder height.

Safety Icons

Safety icons are to remind you of important information while you are operating the unit.



Use caution when operating this power equipment.



Read and understand the Operation Manual before operating the chainsaw.



A chainsaw has sharp blades. Use caution when operating, transporting and handling.



A chainsaw has sharp blades. Use caution when operating around other people and pets.



Wear protective noise deafening headphones when operating.



Wear goggles or other eye protection. The chainsaw can propel wood chips and dust.



Use caution around rotating parts! Do not touch when operating.



Avoid operating in the rain, protect the battery and chainsaw from wet conditions.

Safety Decals

Safety decals on the blower are to remind you of important information while you are operating the unit. Make sure all decals are attached and in readable condition. Replace missing or defaced decals. Contact Redback Tools at 1-800-876-3009 for replacement decals.





CAUTION

**The teeth on the saw chain are very sharp!
Wear protective gloves when performing any work on the chain.
An incorrectly attached saw chain will cause the power tool to
cut in an uncontrolled manner!**

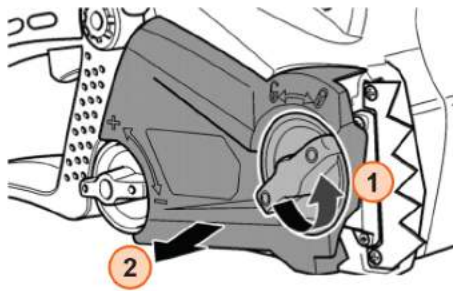

Figure 1

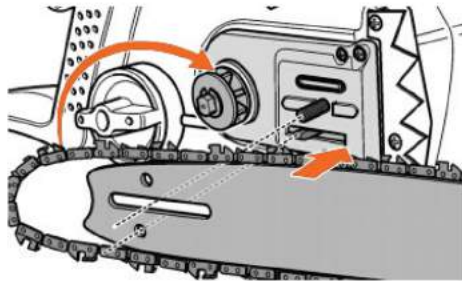

Figure 2

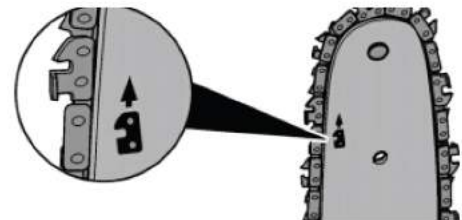

Figure 3

When attaching the chain, ensure that it is in the correct running direction (see Figure 3).

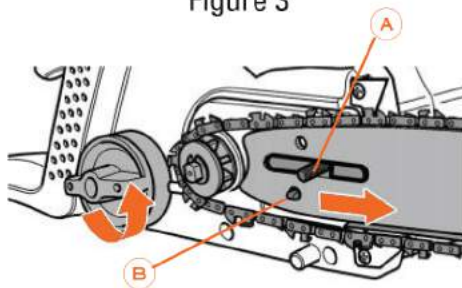

Figure 4

Place elongated hole of the saw rail on the stud bolt (A) and the guide bolt (B) on the chainsaw (see Figure 4).

Place the saw chain around the chain wheel (see Figure 4). Tighten the chain tension wheel counter-clockwise to tension the chain. The saw chain must not sag, but it should be possible to pull it about 1/8 inch off the saw rail in the middle of the saw rail.

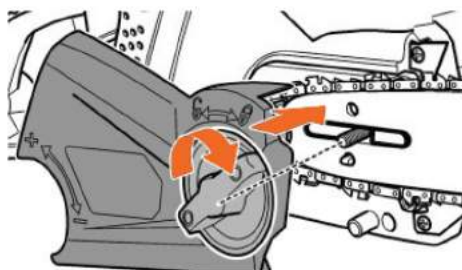

Figure 5

Turn the saw chain by hand to check that it runs perfectly. It must slide freely in the rail. Attach the chain guard. Tighten the hand wheel to attach the rail and the cover (see Figure 5).

NOTE: Check and re-adjust the tension of a new chain after working for a few minutes. Switch the motor off, remove the battery and activate the chain brake.

Add Chain Oil

NOTE: Use only a lubricant that is designated for chainsaws. Other oils may not have the proper viscosity or lubricating properties required.

Ensure that dirt does not get into the oil tank. Avoid spilling oil. Always wipe up any spilled oil. Unscrew the oil tank cap (a). Carefully pour in the chain lubricating oil until it reaches the upper mark on the oil level indicator (b). The maximum tank volume is 5.4 fluid ounces (160mL). Do not overfill. Tighten the oil tank cap (a) by hand.

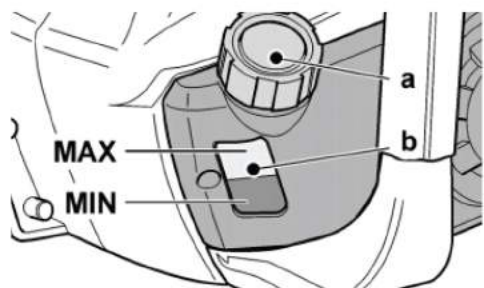

Figure 6

Inserting/Replacing the Battery

Charge the battery as described in the charger operation manual. Press the charged battery into the power tool until it clicks into place.

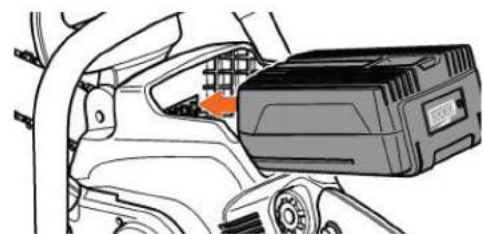

Figure 7

To remove, press the release button ① and pull out the battery ②.



Figure 8



CAUTION

**Protect the battery contacts when the battery is not being used.
Metal objects may short-circuit the contacts and pose
both an explosion and fire hazard!**





WARNING

Before using the chainsaw, always check that the chain brake is in perfect working order. Otherwise, do not use the chainsaw and have it repaired by a qualified technician or a service center.

Chain Brake

The chainsaw features a safety chain brake which stops the chain within a fraction of a second in the event of a kickback. If a kickback occurs, the chain brake is automatically actuated by touching the hand guard with your left hand. Always hold the chainsaw firmly with both hands.

To manually activate the chain brake tilt the hand guard towards the saw rail tip. To loosen the chain brake pull the hand guard towards the handlebar.

Checking the Chain Brake

Place the chainsaw on a secure surface. Loosen the chain brake. Hold the chainsaw with both hands. Turn the chainsaw on. Tilt the hand guard towards the saw rail tip causing the chain to stop.

Lubricating the Chain

Check the amount of oil on the oil level indicator. Always add chain oil when the reservoir is low. Always check the oil level before operating the chainsaw. Check the chain oil level during operation and top up with chain oil as needed. The unit should be operated with adequate chain lubricating oil at all times. Inadequate lubrication will reduce the service life of the chainsaw and require extra effort in cutting.

Checking the chain lubrication

Start the chainsaw and hold the running saw chain 6 inches above a sheet of paper, cardboard or other surface. If there is adequate chain lubrication, the oil in line with the chainsaw will form a light trail visible on the surface.

Overview of Components

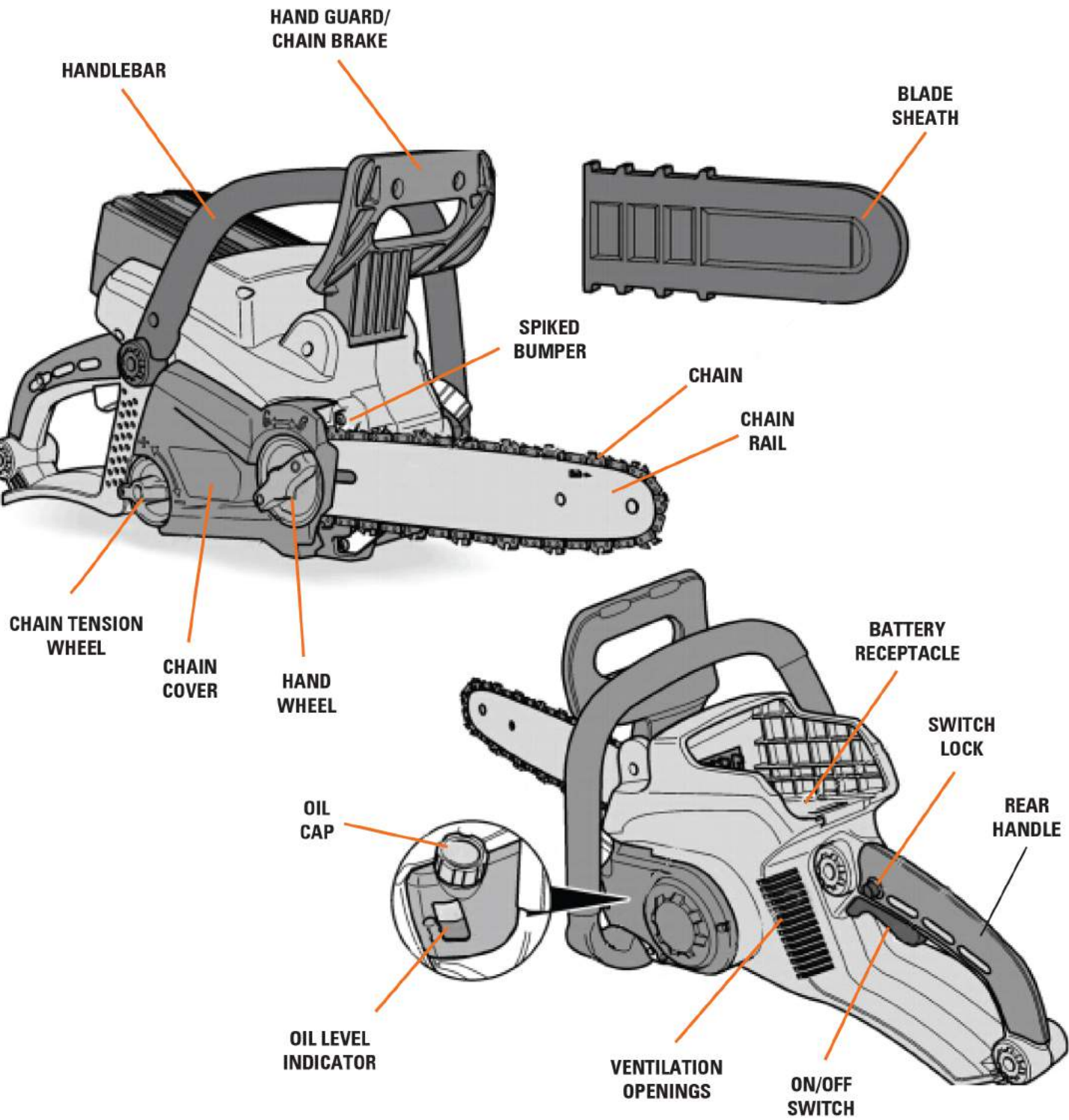

Before Operating

- Check that all parts of the chainsaw are firmly attached and undamaged.
- Check that the chain tension is correct.
- Check that the chain brake functions.
- Check the chain lubrication.
- Check that there are no leaks.
- **Never work on unstable ground!**
- **Never work above shoulder height!**
- **Never work while standing on a ladder!**
- **When working, always hold the power tool with both hands!**

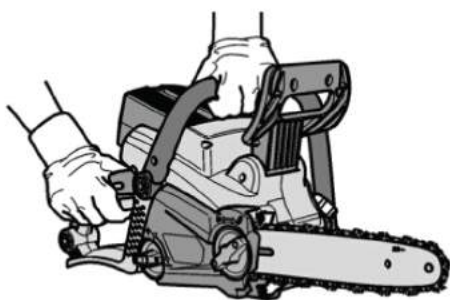

Figure 9



Figure 10

Switching the Chainsaw ON

Make certain that the saw chain has not yet been positioned for cutting and is not touching any other objects. Hold the chainsaw firmly with both hands (see Figure 9). Ensure that the chain brake is released before starting the chainsaw (see Figure 10). To do this, pull the hand guard back towards the handlebar.

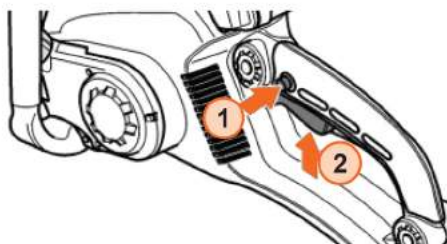

Figure 11

Press and hold down the switch lock ① (see Figure 11). Press and hold the rear On/Off switch ②.

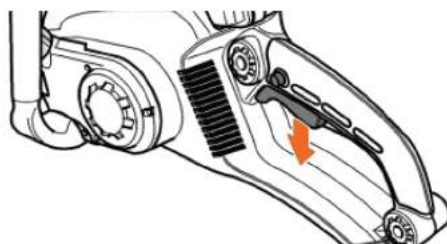

Figure 12

Switching the Chainsaw OFF

Release the On/Off switch (see Figure 12).

After Operation

Always switch the motor off before you put the power tool down! When the On/Off switch is released, the saw chain continues running briefly. Stop the motor. Wait until all rotating parts have come to a standstill. Remove the battery. Activate the chain brake. Place sheath on cutting mechanism. Leave power tool to cool down.

Sawing Technique

This section deals with the basic working technique when handling the chainsaw. The information given here does not replace the extensive training and experience of a specialist. Avoid any work for which you are not adequately qualified! Imprudent handling of the chainsaw may result in extremely serious or fatal injuries!

Pull Stroke Sawing

With this technique the underside of the saw rail saws from top to bottom (see Figure 13).

The saw chain pushes the power tool forwards away from the user. The front edge of the power tool forms a support which absorbs the forces which occur when sawing on the tree trunk. In pull stroke sawing the user has much more control over the power tool and can better avoid kickbacks. Therefore this sawing technique is preferred.

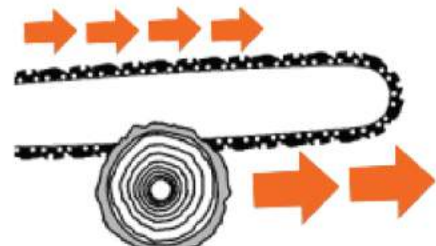

Figure 13

Push Stroke Sawing

With this technique the upper side of the saw rail saws from bottom to top (see Figure 14).

The saw chain pushes the power tool backwards towards the user.

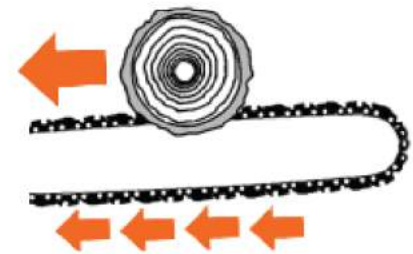

Figure 14



WARNING

If the saw rail jams, the power tool may be thrown back towards the user with great force.

If the user does not use his physical strength to compensate for the force of the saw chain pushing backwards, there is a risk that only the tip of the saw rail will make contact with the wood and cause a kickback with a risk of death or severe injury!

Removing branches

- Start at bottom of the trunk and work upwards (see Figure 15).
- 4-6 inches (10-15 cm) from the base of the branch saw upwards into the branch 1/3 of the branch diameter ①.
- A little further up the branch saw through the branch from top to bottom ②.
- Make a cut close to the trunk ③. Make the cut from top to bottom.

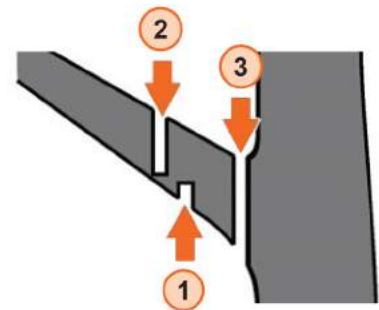

Figure 15

Felling a tree



Risk of injury!

Felling and limbing work may be performed by trained persons only! There is a risk of life-threatening injuries!

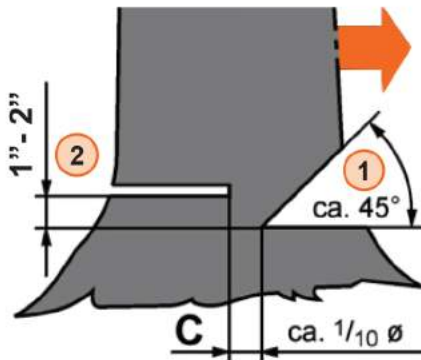

Figure 16

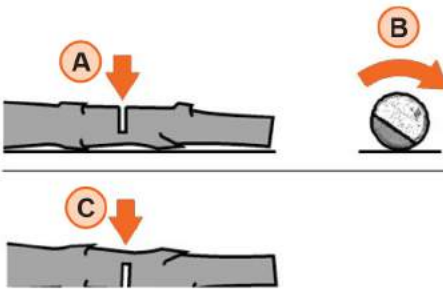

Figure 17

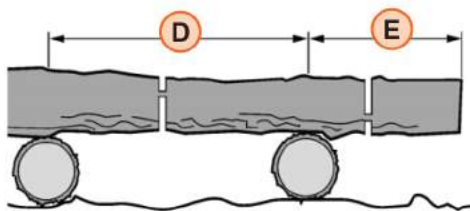

Figure 18

Before starting felling work, ensure that there are no unauthorized persons and no animals within the fall area of the tree and there is an obstacle-free escape route for all those involved. People should withdraw opposite the direction of the fall; the area around the trunk should be free of obstacles (risk of tripping!) and the next workplace is at least two and a half tree lengths away. Before felling the tree, check the direction in which the tree will fall and ensure that there are neither objects nor persons or animals within a distance of 2½ tree lengths.

A tree is felled in two stages:

Notch the trunk by approx. one third of its diameter on the side of the direction of fall ① (see Figure 16).

On the opposite side make the felling cut ② which must be slightly higher than the notch (approx. 1 - 2 inches).

Cutting limbs and trunks lying flat on the ground

Cut halfway into the trunk ①, then turn around ② and saw through from the opposite side ③ (see Figure 17). When sawing through the trunk, ensure that the saw rail does not touch the ground!

Cutting Supported Limbs and Trunks

We recommend supporting trunks, which are to be sawn through, on sawhorses. If this is not possible, the trunk should be raised and supported with the aid of supporting branches or via support blocks (see Figure 18).

In area ① first cut approx. one third of the trunk diameter from top to bottom, then complete the cut from bottom to top.

In area ② first cut approx. one third of the trunk diameter from bottom to top, then cut through from the top.

Do not saw trunks which are under tension! Splintering wood or a jammed saw rail may result in serious injury!



CAUTION

Before performing any maintenance on the chainsaw, remove the battery.

Cleaning the Chainsaw

Remove the battery. Do not use water or liquid detergents. Whenever possible, always clean the unit directly after use with a hand brush.

Keep the ventilation slots clean and dust-free.

Repairs

Check the unit for damage. Repairs may be carried out by an authorized customer service center only.



Storage

Remove the battery from the chainsaw before storing. Store the chainsaw in a dry, dust-free and frost-free place ideally in a temperature range of 50° - 77°F (10-25 °C).

Store the battery and the unit separately.

The chain rail can be removed for storage.

Charge the battery before storing the unit in winter.

Keep the unit, in particular its plastic components, away from brake fluids, petrol, petroleum products, penetrating oil, etc. They contain chemical substances which may damage, attack or destroy the plastic components of the unit.



Remove the battery from the chainsaw when not in use.

Disposal Information

Recycle raw materials instead of disposing as waste.

Battery, accessories and packaging should be recycled in an environmentally friendly manner. Plastic parts are identified for recycling according to material type.



CAUTION

Do not use batteries with damaged casing.

Do not attempt to open batteries.

Do not dispose of in fire, water or household waste.

Warranty & Specifications

IMPORTANT NOTICE

We, the manufacturer, reserve the right to change the product and/or specifications in this manual without notification. The manual is for information usage only and the pictures and drawings depicted herein are for reference only.

Warranty Repair and Service

Do not return this product to the store for warranty issues or repair. Call our customer service department at **1-800-876-3009** or email us at **support@redbacktools.com**. You can extend your warranty by registering your product at **www.redbacktools.com**.

Record the information below for future reference.

Model No. _____

Serial No. _____

Date of Purchase _____

Place of Purchase _____

SKU/Part No.	EA435C
Battery Type	Lithium-Ion
Description	40v Lithium Ion ChainSaw
Rated Voltage	40 Volts DC
Chain Speed	32.8fps
Cutting Length	10"
Oil Tank Capacity	160ml
Run Time	60min max
Chain Replacement	91PJ04
Chain Pitch	3/8in (Low Profile)
Chain Gauge	.050in (1.3mm)
Sharpening File Size	5/32in (4mm)
No. of Drive Links	45
Bar Replacement	120SDEA041
Shipping Weight	5.5lbs (Without battery)
Warranty	1-Year Limited Warranty



For Service or Questions

1-800-876-3009

www.redbacktools.com

email us at support@redbacktools.com