



**Installation and Operating Manual**  
**Smart Comfort 5/SC-FT**  
- Please forward to the user -

<b>Contents:</b>	<b>Page:</b>
About this manual, Safety instructions, Disposal	2
Technical data, Shipping unit and dimensions	3
Installation	5
Electrical connection	7
Specify the connected device type	12
Programming mode	13
DIP-switch settings	14
Operating element - setting options	15
Symbol descriptions	16
Factory settings	18
Filter replacement and filter cleaning	19

- Read this manual carefully and completely before assembly! Always observe the general safety instructions and the safety symbols with information in the text.
- Hand out this manual to the user (tenants, proprietors, property management etc.) after completing assembly.
- **Symbols in this manual:**



This symbol warns you against risks of injury



This symbol warns you against risks of injury from electricity

### **Safety instructions**



**Caution!** Any assembly work may only be carried out after disconnecting the supply voltage!



**Attention!** The electric connection may only be made by authorised qualified personnel and according to the applicable version of VDE 0100!

### **Disposal**



The packaging must be sorted before disposal. If you wish to dispose of the ventilation device, observe the currently applicable regulations. Pursuant to the German Electrical and Electronic Equipment Act (ElektroG) this device can be returned to your municipal collection point free of charge.

**Control**

Operating voltage:	12 V DC
Functional voltage range:	0 - 10 V
Operational switching current:	max. 5 A
Connected load:	max. 60 W

**Power supply units**

Input voltage:	100 - 240 V AC
Output voltage:	12 V DC

Types:	Order No.: 39973
5/NT18	Order No.: 39974
5/NT60	Order No.: 40096
5/NT100	

**Shipping unit**

The control and the operating unit with frame are supplied as one shipping unit. The power supply is a separate shipping unit. A switch box is to be provided by the customer.

**Please check the delivery for completeness and mint condition!**

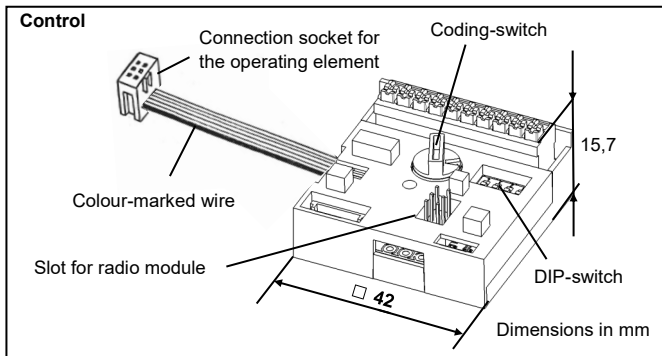

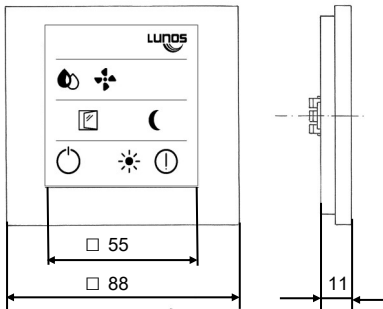
**Operating element  
with frame****Power supply**

Example 5/NT18

(not in the scope of delivery)

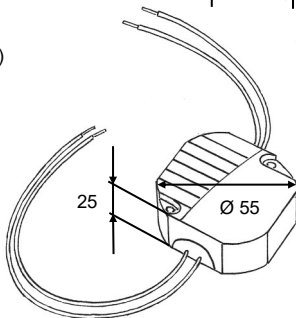

Dimensions in mm

The control unit, the operating element and the power supply can be appropriately installed in a standard switch box (90 mm deep), as shown.

If the power supply is installed at a different location, a simple, 42 mm deep switch box will be sufficient.

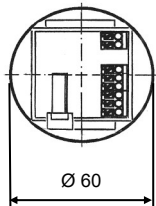
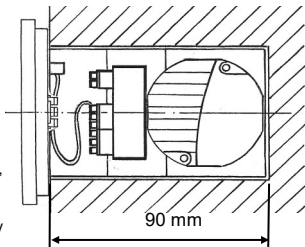

Power supply (to be connected according to circuit diagram)

Switch box 90mm

Metal carrier plate (8x hook on the on the top)

Control unit

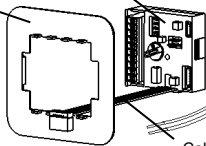
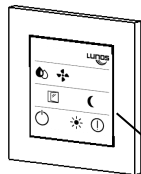

Cable

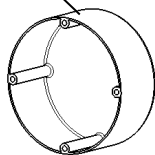

Operating element snapped into place in the frame

### Attention!

Connect control unit and operating element only via the cable of the control unit!  
An extension of the cable is not possible!

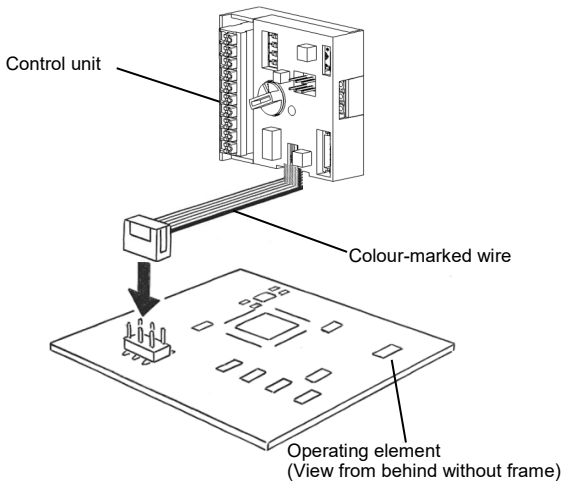

Plug the operating element and the control unit together correctly, using the colour-marked wire of the connection cable for orientation.

Safety instructions

Caution! Any assembly work may only be carried out after disconnecting the supply voltage!



Before connecting the device to the mains voltage, make sure that all connection lines are voltage-free (dead)! (Separation from the power supply with a minimum contact opening of 3 mm, e.g. electric fuse).



Each electric circuit of this ventilation system must be fitted with a residual current protection (e.g. FI switch/RCCB)!



Electrical connection only by a specialist.

Additional installations and electrical components in the ventilation unit are not admissible!

Use the following cables for electrical connection:

- Cable to the ventilation devices: e.g. J-Y (St) Y 2 x 2 x 0.8 min. 0.5 mm<sup>2</sup>, max. 1.5 mm<sup>2</sup>
- Cable for the supply voltage: e.g. NYM 3 x 1.5 mm<sup>2</sup>

Colour-marked wire

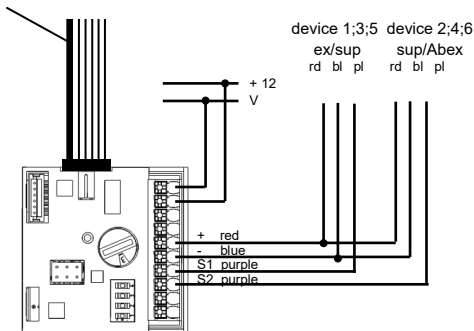

Maximum number of  
connectable ventilation  
units:

Power supply	e <sup>2</sup>
5/NT18	6
5/NT60	10
5/NT100	10 + 10



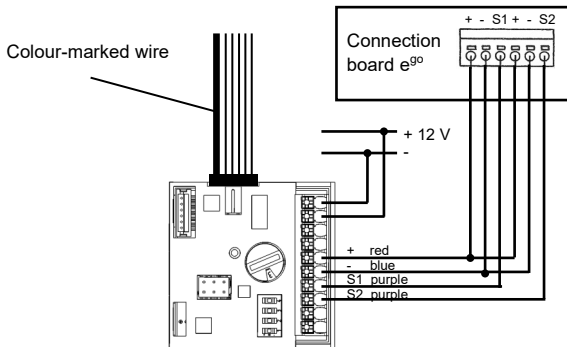

Maximum number of connectable ventilation units:

Power supply	e <sup>90</sup>
5/NT18	3
5/NT60	5
5/NT100	5 + 5

Colour-marked wire

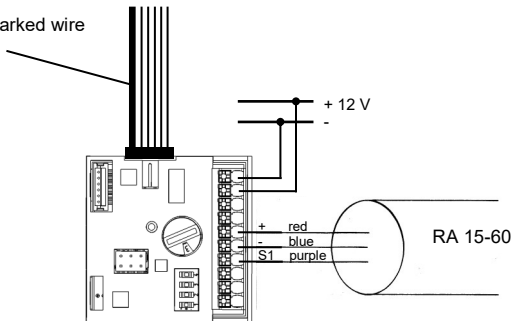

Maximum number of connectable ventilation units:

Power supply	RA 15-60
5/NT18	1
5/NT60	1 + 1
5/NT100	1 + 1 + 1

Colour-marked wire

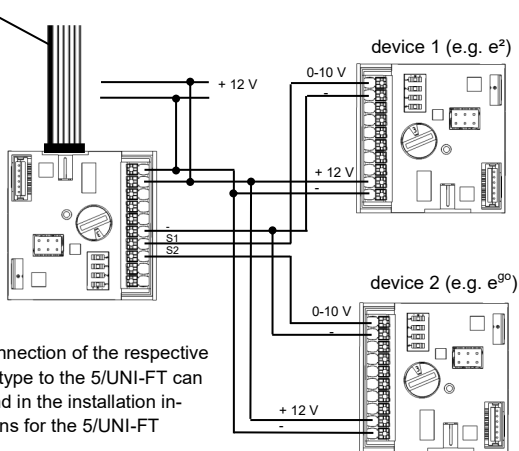

The connection of the respective device type to the 5/UNI-FT can be found in the installation instructions for the 5/UNI-FT

The connected device type must be set on the coding switch according to the following table. It can basically be switched in five or eight stages. The listed nominal volume flows apply to the respective illuminated LED. DIP switch 2 can be used to choose whether the ventilation system should run with a permanent base load or whether it should be able to be switched off (see DIP switch settings).

	Typ	DIP 4 active	Stage 1	Stage 2	Stage 3	Stage 4
0	RA 15-60	-	15 m <sup>3</sup> /h*	30 m <sup>3</sup> /h*	45 m <sup>3</sup> /h*	60 m <sup>3</sup> /h*
3	e <sup>2</sup>	e <sup>2</sup> short	15 m <sup>3</sup> /h	20 m <sup>3</sup> /h	30 m <sup>3</sup> /h	38 m <sup>3</sup> /h
5	e <sup>2</sup> 60	e <sup>2</sup> 60short	5 m <sup>3</sup> /h	20 m <sup>3</sup> /h	40 m <sup>3</sup> /h	60 m <sup>3</sup> /h
9	e <sup>90</sup>	only HRV**	5 m <sup>3</sup> /h	10 m <sup>3</sup> /h	20 m <sup>3</sup> /h	45 m <sup>3</sup> /h*
C	e <sup>2</sup> 60***	e <sup>2</sup> 60short	Unpaired operation, levels like P5			
E	0-10 V		Levels according to each device			
F	Programming mode (description see page 13)					



\* exhaust air only

\*\* in pure operation with heat recovery, stage 4 also runs at 20 m<sup>3</sup> / h in reversing operation

\*\*\* unpaired operation works only with e<sup>2</sup>60 devices. Connect one device to S1 and two devices to S2

A calibration of the flowrates is also possible and is described in the extended functional description at [www.lunos.de](http://www.lunos.de).

De-energize the control, set the coding switch to position F and restore the power supply. The event LED flashes continuously and signals the activated programming mode. Briefly press the buttons listed below to activate and deactivate the respective function. The settings are accepted by pressing the ON / OFF button for 3 seconds. Discarded by pressing the Sun button for 3s. De-energize the control and set the coding switch again according to the table on the previous page.



Function	Button	LED feedback
Intelligent* humidity control		1.LED flashes, intelligent control active 1.LED OFF, intelligent control deactivated
Filterreplace-ment indicator		2.LED flashes, indication active 2.LED OFF, indication deactivated



\* The regulation takes place almost continuously and in an "intelligent" way, in which a distinction is made between permanently high relative humidity or a rapid increase (e.g. by showering).



If the relative humidity cannot be reduced significantly within a period of two hours (e.g. in summer), the fan is switched to the basic ventilation level.



If the relative humidity increases by more than 5% within one hour during the lowering mode, the lowering mode is ended. If the lower switching threshold is not reached and the basic ventilation level is set to OFF, the fan is switched off.

If the intelligence is deactivated, the system is only regulated according to the measured relative humidity. This can lead to increased ventilation volume, especially in summer, and humid and warm air may be transported into the interior.

-  Interval operation OFF
  -  Every 4 h for 30 min on stage 3
  -  Every 2 h for 15 min on stage 3
- 1 2 3 4

-  Without base ventilation
  -  Base ventilation, OFF during the night possible, max. 8 hours
  -  Landlord protection, permanent base vent. on lowest stage
- 1 2 3 4







-  50% - 70%
  -  45% - 75%
  -  55% - 65%
- 1 2 3 4

-  Special function deactivated
  -  Special function activated (see table page 12)
  -  -
- 1 2 3 4

## Factory settings



White DIP-switch

Symbol	Single button press	Button pressed for 3 seconds	Button pressed for 10 seconds
	Activating or deactivating the humidity-sensitive automatic mode	Setting of the lowest ventilation stage in the automatic mode	-
	Setting of the airflow volume	Changeover between 5-stage and 8-stage operation	-
	Activating or deactivating the intensive ventilation	Changing the runtime of the intensive ventilation	Setting of the stage for the intensive ventilation
	Activating or deactivating the night-time reduction	Defining the runtime of the night-time reduction	Defining the active stage during night-time reduction
	Activating or deactivating the summer mode	Defining the operating time of the summer mode	-
	Switching on the ventilation system Setting of the LED brightness level	Switching off the ventilation system	-
	-	Resetting the filter replacement	-

An advanced feature description can be found on [www.lunos.de](http://www.lunos.de)

The Smart Comfort offers you the possibility to switch all functions of your ventilation devices and to recognize their current operating status. It contains a humidity sensor, which controls the ventilation devices appropriately in automatic operation.

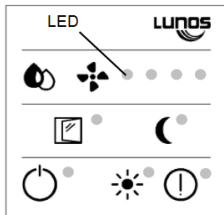

### Drop

The humidity-sensitive automatic mode is activated or deactivated via the button with the drop symbol. In automatic mode, the LEDs 1-4 light up in low brightness. The active stage is displayed with full brightness. In the standard, the first stage is switched at a relative humidity of 50%. The highest ventilation stage is switched from a humidity value of 70%.



### Fan

The ventilation stage can be set using the "Fan" button. The manual adjustment of the ventilation stage is performed in a rolling manner, i.e. each pressure on the button increases the stage by one. After the highest stage, the lowest stage or OFF follows again. When the automatic mode is activated, manual changes of the ventilation stage are valid for one hour.



**Window**

The window symbol stands for the intensive ventilation mode. When activated, the LED next to the symbol illuminates continuously and the fans change to the highest available ventilation stage. The mode automatically ends after the set time (factory setting: 30 minutes). The ventilation system then switches back to the previously set operating mode (manual or automatic mode).

**Moon**

Pressing the "Moon" button activates or deactivates the night reduction. In the factory setting, the ventilation system goes to the "OFF" stage and the LEDs light up with low brightness. The system automatically returns to the previously set mode after the set time has elapsed (factory setting: 8 hours). The LEDs light up again with full brightness.

**Sun**

This button is used to activate and deactivate the summer mode. When the mode is active, the LED next to the symbol illuminates. By the activation, only the reversing time, i.e. the change between supply air and exhaust air operation of each unit, is increased to one hour. The mode runs according to the set runtime (factory setting: 8 hours). By the increase, heat recovery is bypassed and cool air can be supplied to the utilisation unit and distributed by means of effective cross ventilation.

## Symbol descriptions



### ON/OFF

The brightness of the LEDs can be adjusted in a rolling manner by a simple push of this button. It is switched between OFF, dark and bright.

If the button is pressed for three seconds, the ventilation system will be switched off completely. To turn a flick of the button.



### Event

Press the "Event" button for 3 seconds to confirm that a filter replacement has been carried out. A successful reset is confirmed by a triple flashing of the Event LED.

## Factory settings

EN

The factory settings are as follows:

- Device type: e<sup>2</sup>
- Automatic mode: the lowest stage in humidity-sensitive mode is the lowest ventilation stage, i.e. without OFF. Control range 50% -70%
- Intensive ventilation: active for 30 minutes, highest ventilation stage
- Night reduction: active for 8 hours, ventilation stage OFF
- Summer ventilation: active for 8 hours, reversing time 1 hour

By pressing and holding the "Sun" and "Event" buttons for 10 seconds, the factory settings are restored. The control starts again and all LEDs light up briefly three times.

The event LED of the operating element illuminates continuously to signalise that a filter is dirty.

Remove the inner screen of the ventilation unit, remove the filter, insert the new or cleaned filter, put the inner screen back on.

Reset the filter monitoring display by pressing the "Event" button for three seconds. The function is reset.

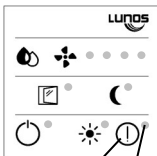

Event button

Example inner screen e<sup>2</sup>

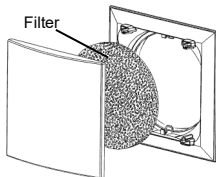

LED illuminates continuously when filter is dirty

Please note the filter replacements you have carried out. (Filters should be changed approx. 3 months after the last filter replacement):

Filter replacement date	Expected filter replacement	Type of filter used

**LUNOS Germany**

LUNOS Lüftungstechnik GmbH &amp; Co. KG

für Raumlufsysteme

Wilhelmstr. 31

13593 Berlin · Germany

Phone +49 30 362 001-0

Fax +49 30 362 001-89

info@lunos.de

www.lunos.de