

FLIP ZERO

ELECTRONIC VIBRATION

English

INCLUDED PARTS

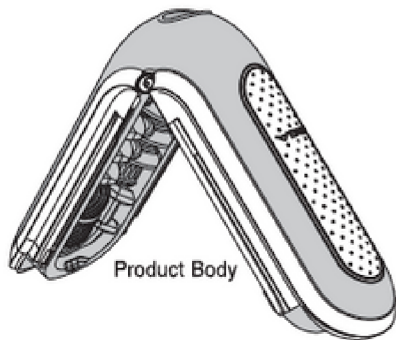

Transportation
Anchor Ring

※ Please remove and
dispose of after opening.



Clear Case

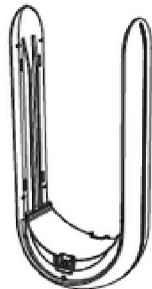

Slide Arms



Charging Base



USB Cable



Pouch of HOLE LOTION REAL X2

SET UP / CHARGING

- 1 Connect the USB cable to the Charging Base, then plug into a USB port or wall plug adapter.

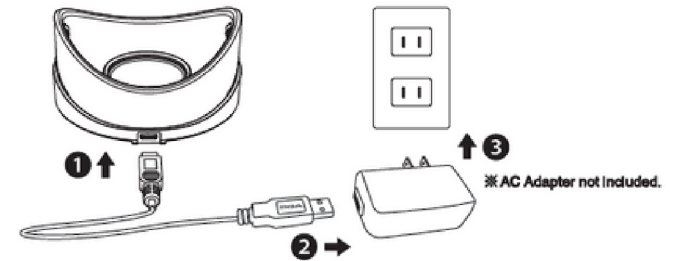

⚠ Please charge fully before first use.

- 2 Place Product Body, with Slide Arms attached, directly onto the Charging Base upright. (The button can be facing up or down - the item will charge in either position.)
 - ※ Ensure the Charging Base and Slide Arm connectors are in contact.
 - ※ Ensure the connectors are clean.

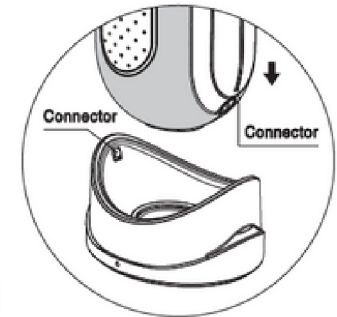
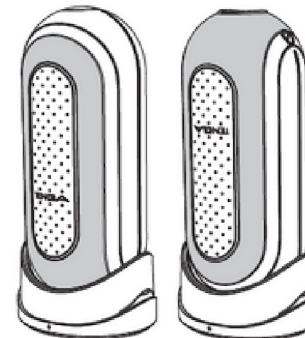

- 3 The Charging Lamp will turn on when the item is charging. When the lamp turns off, charging is complete.

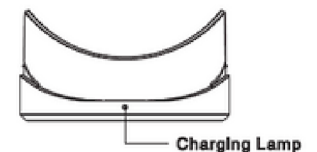

⚠ To maintain product quality, please ensure to fully charge at least once every 6 months.

HOW TO OPEN

① Remove Slide Arms from Product Body

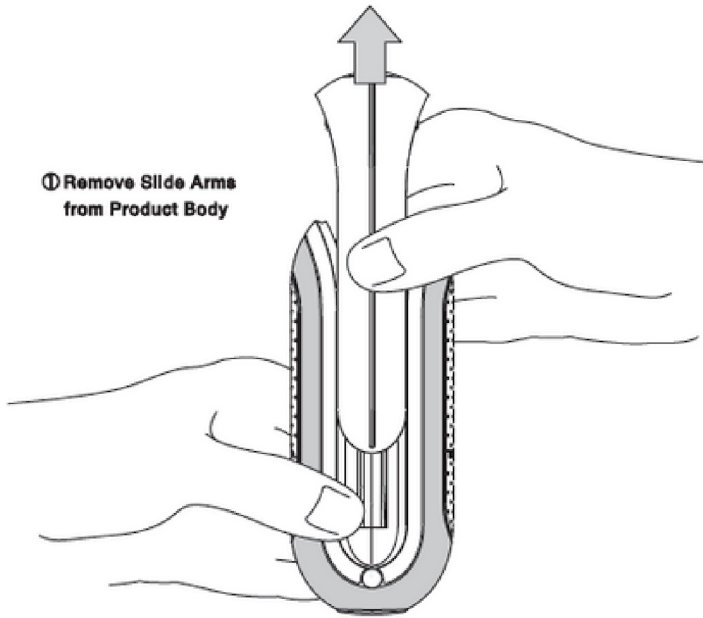

② Hold Product Body by the Slide Arm rails from both sides and squeeze until both locks click open.

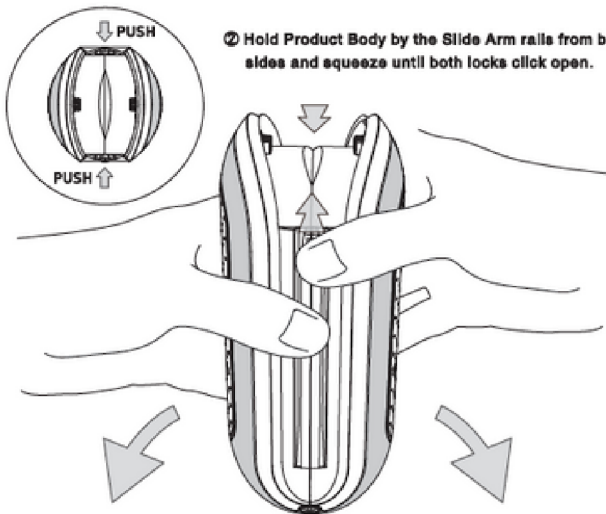

BEFORE USE

① Fully lubricate the inside of the item.

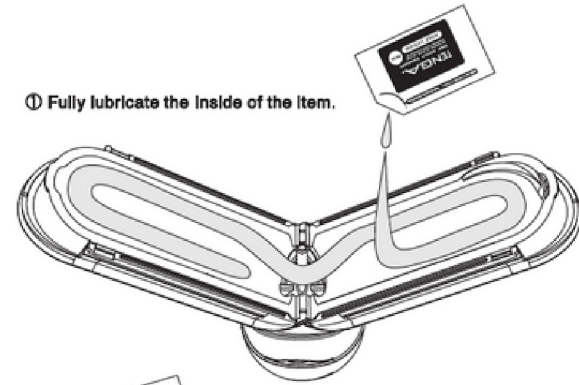

② Close the item ensuring both locks click shut, and slide on the Slide Arms. Lubricate the insertion point.

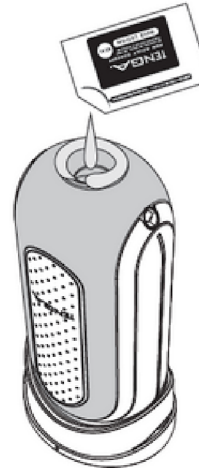

⚠ Over-lubrication may lead to spillage from the One-Way Valve. While this may vary by user, we suggest 10~20ml of our HOLE LOTION for best use.

After you have used up the included tester pouches of HOLE LOTION, we suggest Tenga HOLE LOTION (sold separately) for further uses.

MILD REAL WILD SOLID

※ Included pouches are of HOLE LOTION REAL.



HOW TO CHANGE MODES

Turn the product on by pressing and holding the Button for 2 to 3 seconds.

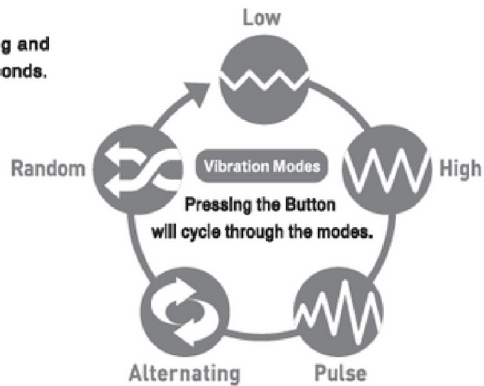
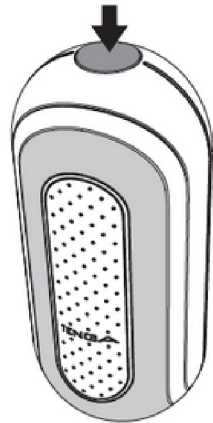

※ After use, be sure to press and hold the button to turn the item OFF. Removing the Slide Arms will cause the vibrations to stop, but does not turn the item OFF.

HOW TO USE THE PRESSURE PADS

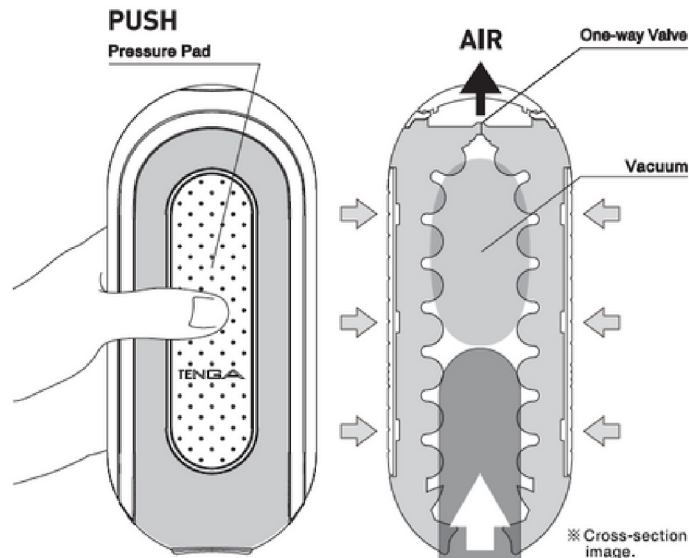

After Insertion, you can use the Pressure Pads to manually control the pressure, or squeeze out the Internal air to create strong vacuum suction.

HOW TO CLEAN THE PRODUCT / SLIDE ARMS

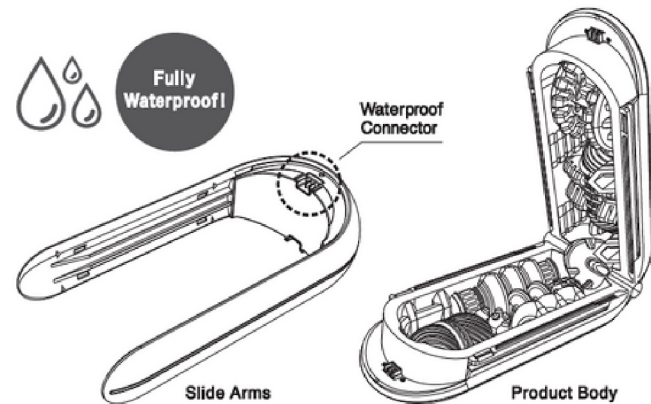

- After use, first turn the product OFF. Remove Slide Arms, open the Product Body and wash both thoroughly with cold or tepid water.
 - ※ If you wish to use soap, please ensure it is a mild or neutral soap.
 - ※ After washing, thoroughly dry the Waterproof Connector with a towel or cloth.
- Pat dry with a dry cloth.
 - ※ Do not wash with hot water. ※ Do not leave the product submerged in water for extended periods of time, or attempt to boil the product.
 - ※ Alcoholic or highly acidic/alkaline cleansers can lead to product damage, so please refrain from use.
 - ※ The elastomer sleeve may discolor with repeated use.

HOW TO CLEAN THE CHARGING BASE

- Always unplug the item and remove cables from Charging Base before cleaning.

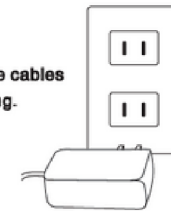

- Clean with a wrung-out, damp cloth.
 - ※ Do not wash with water, the Charging Base is NOT waterproof.

NOT Waterproof!

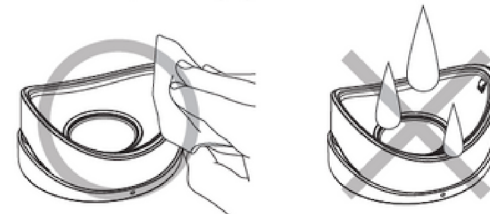

⚠ To avoid electric shocks, electrical damage or fire hazards, please do NOT submerge Charging Base in water. Please do not place anything other than the Product Body or Slide Arms on the Charging Base.

HOW TO DRY & STORE

Pat dry with a dry cloth after washing.

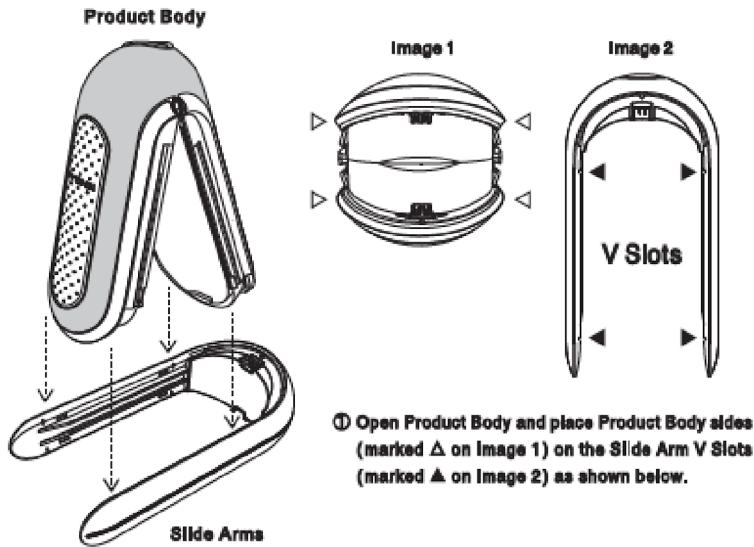

- ① Open Product Body and place Product Body sides (marked Δ on Image 1) on the Slide Arm V Slots (marked ▲ on Image 2) as shown below.

- ② Place in a well ventilated area to air dry.
※ Please dry well to ensure hygienic storage.

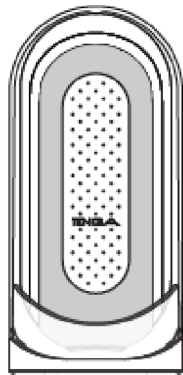
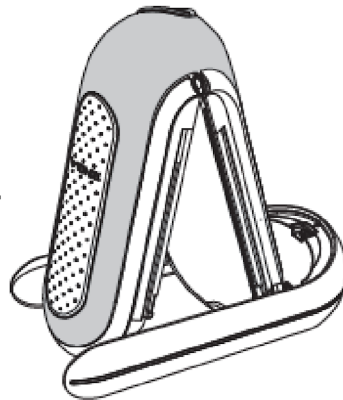

- ③ Once fully dry, close Product Body, replace Slide Arms, place on the Charging Base and cover with the Clear Case.
※ Store in a cool, dry, dark place away from direct sunlight and/or humidity.

CHARGING THE ITEM WHILE DRYING

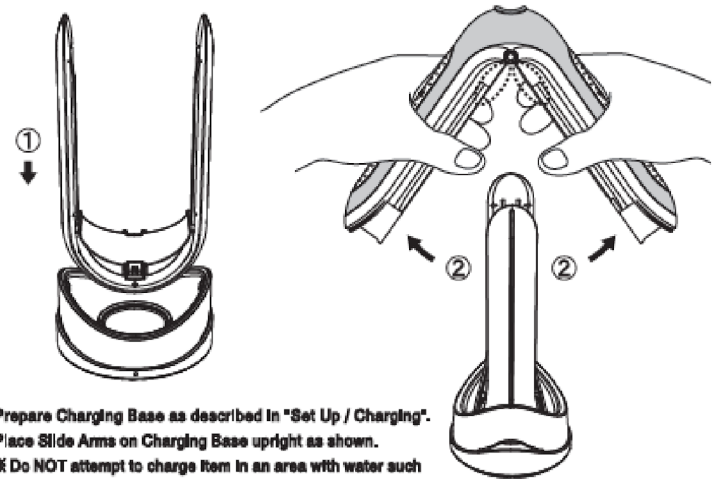

- ① Prepare Charging Base as described in "Set Up / Charging". Place Slide Arms on Charging Base upright as shown.
※ Do NOT attempt to charge item in an area with water such as the bathroom.

- ② With the Product Body open, place onto the Slide Arm Slots as shown.

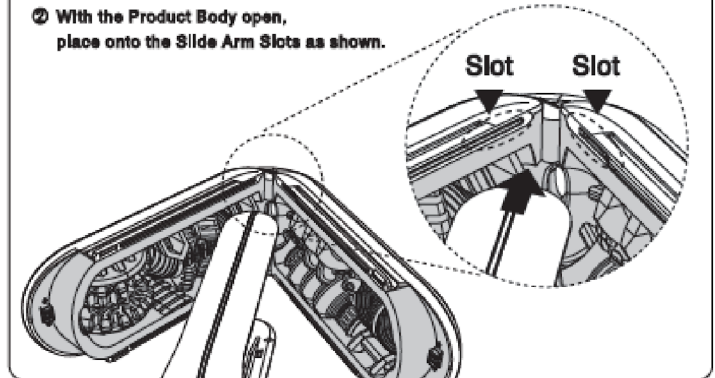

- ③ Place in a well ventilated area to air dry.
※ Please dry well to ensure hygienic storage.

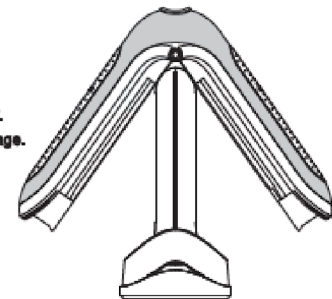

TROUBLESHOOTING

- **The product won't turn On**
 - **Press and hold Button for 2~3 seconds.**
 - **Ensure the item is fully charged.**
 - **During charging, ensure all terminals are properly plugged in.**
- **The product won't stay on / the vibration is weak**
 - **Ensure the item is fully charged.**
 - **Deplete the battery completely once, then fully charge.**
There are cases where doing so several times will fix the problem.
 - **If a long time has passed since purchase, the product life of the battery may have ceased.**
- **The product won't charge / Charging Lamp won't turn on**
 - **Ensure all terminals are properly plugged in.**
 - **Ensure USB cable is connected the right way up on the Charging Base.**
 - **Ensure product isn't already fully charged.**
- **If the product isn't fully charged after 90 minutes, there may be a problem with the charging connection. Ensure Slide Arms are facing straight up and connectors of Charging Base and Slide Arms are touching on both sides.**

USAGE WARNING

- **Keep away from direct sunlight, and areas that get hot and humid.**
These can lead to product malfunction, overheating of product, or fire hazards.
- **Silicone-based / oil-based lubricants / other oils such as massage oil or baby oil may cause damage to the product material.**
- **Do not store in humid areas such as bathrooms. Do not store before fully drying.**
- **Ensure product is fully cleaned, leaving no fluids on the item before storing.**
- **Do not use alcoholic or acidic/alkaline cleaners. Do not wash with hot water.**
Doing either could lead to product discoloration or deformation.
- **Do not drop or expose to strong forces. This may lead to product malfunction, electric shock or electrical damage.**
- **Charge only with peripherals included. Do not charge other products with included peripherals.**
- **To avoid fire hazards, do not use near fire or open flames.**
- **If you feel unwell or any discomfort during use, stop use immediately and contact a medical professional.**
- **When removing USB cables, always hold USB cables at the ports and terminals.**
Damaged USB cables can be cause for electrical or fire hazards.
- **When removing AC adapters, always pull while holding the adapter itself.**
Do not pull by the cable. Damaged USB cables can be cause for electrical or fire hazards.
- **Do not use item during charging process.**
- **This product is designed to be reusable, but if you notice any damage please cease use immediately and turn the item OFF. Damaged items may cause accidents or injuries.**
- **Always disconnect cables during cleaning. Ensure your hands are dry before removing cables.**
Not doing so may lead to electrical hazards.
- **Disconnect cables at all times when not charging the item.**
Build-up of dust or dirt on connections may lead to fire or electrical hazards.
- **Keep out of reach of children.**
- **TENGA Co., Ltd. and its subsidiaries cannot be held liable if any parts of the item are ingested.**
- **Do NOT share this item with others.**
- **This product is a novelty item. TENGA Co., Ltd. cannot be held liable for any use other than its intended use. Please use at own risk.**

Disposal of Product

This product includes a Lithium Ion Battery. Please consult your local authorities regarding disposal of items that house Lithium Ion Batteries.

PRODUCT WARRANTY

This product is covered by a One Year Warranty from the date of purchase. Please note the warranty will not cover the following circumstances.

● If you are unable to provide a valid proof of purchase. ● If the product damage is due to your use or breaking of the item. ● If you attempted to dismantle or modify the item, or attempted to have it fixed by unauthorized parties. ● If the damage was caused by dropping or other accidental damages after purchase. ● If the item was damaged in cases such as house fires or natural disasters. ● If the item is damaged from normal wear-and-tear of product during fair use. (This includes discoloration of elastomer sleeve.)

WARNING

- If you are wearing a pacemaker, or any other medical device, please consult a doctor before use.
- The Product Body, Slide Arms and Charging Base all house powerful magnets. Do not expose items that can be affected by magnetic fields, such as smartphones, watches, IC cards or music players to these magnets, as it could damage your items.
- Ensure all connectors, plugs and sockets are clean.
Built-up dust or dirt can cause electrical and/or fire hazards.
- Do not attempt to dismantle or modify the product. This may lead to dangers such as fire and electrical hazards, among other possible physical injuries.
- Do not charge while the product is ON. This may lead to product malfunctions or fire hazards.
- Do not place any metallic items on the Charging Base.
This may lead to electrical hazards such as electric shocks, or fire hazards.
- Do not use USB cables if they are damaged. This may lead to electrical and fire hazards.
- Do not attempt to bend USB cables or excessively pull on them. Do not wrap USB cables around the Charging Base. Do not store these items under heavy objects or near heating appliances.
This may lead to electrical or fire hazards.
- To avoid electric shocks, electrical damage or fire hazards, please do NOT submerge Charging Base in water.
Clean with a wrung-out, damp cloth. Do not wash with water, the Charging Base is NOT waterproof.