

INSTALLATION GUIDE

ACCUAIR
SUSPENSION



AA-4279

2019-PRESENT

JEEP GLADIATOR (JT)

AIR SUSPENSION SYSTEM



CONGRATULATIONS!

Your AccuAir® Jeep JT Air Suspension system reflects a unique solution to balancing enhanced off road terrain and obstacle clearance with everyday drivability and ride quality. The AccuAir® JT system features remote mounted seamless air tank, a quality compressor, mounts and all fittings necessary to replace your coil springs with ruggedly designed four corner air bags allowing you to select a ride height tailored to your off road adventures. Back on the road, a unique speed sensing value presets ride height to a maximum of 4.0" of lift (approx.), helping to preserve familiar ride comfort. Enjoy your AccuAir® JT system by Treading Lightly® and following all instructions and product safety messaging below. If you have further questions contact us at: sales@AccuAir.com. Our team is here to help.

A FEW WORDS ABOUT PRODUCT SAFETY

Before installation, please take a moment to review the following safety information and installation instructions. Important safety information is generally preceded by one of three signal words indicating the relative risk of injury. The signal words mean:



WARNING:
A hazardous situation which, if not avoided, could result in death or serious injury. You **CAN** be **killed** or **seriously hurt** if you don't follow instructions.



CAUTION:
A hazardous situation which, if not avoided, could result in minor or moderate injury. You **CAN** be moderately **hurt** and may also suffer property damage if you do not follow instructions.



NOTICE:
Careful attention is required to this instruction or operation but does generally not relate to personal injury. Damage to your AccuAir® product or other property may result if you don't follow instructions.

The suspension of this vehicle has been optimized for off road utility through installation of an AccuAir® system allowing control/adjustment of ride height to accommodate challenging terrain & obstacles. The suspension feel and handling maybe different than an unmodified Jeep.

To reduce risk of roll-over other accident & serious injury always:

- Inspect components including bags, lines, valves & compressor before use, followed by system self-test. Maintain & repair as indicated. On road height limited to approx. 4.0" by system speed & ride height sensors. **REPLACE & DO NOT USE ON ROAD IF SPEED SENSOR DAMAGED/INOPERATIVE.**

- DO NOT** modify or substitute AccuAir® components of this system. Use of oversize tire/wheel combinations may increase stopping distances, ride height and/or compromise performance of vehicle stability control and other systems.
- Avoid excessive speeds, abrupt maneuvers, surfaces/obstacles which may induce a tripping moment. All occupants **BUCKLE UP & USE** supplemental restraints.
- Consult the AccuAir® installation manual (sales@AccuAir.com) & OEM off road supplement for additional safety information.

⚠ WARNING: SUSPENSION MODIFIED WITH VARIABLE HEIGHT AIRBAGS - HIGHER ROLLOVER RISK



Inspect Components Followed by System Self-test.

DO NOT Modify or Substitute AccuAir® Components of This System.

Avoid Excessive Speeds, Abrupt Maneuvers, Surfaces/Obstacles Which May Induce a Tipping Moment.

Always Buckle Up.

See AccuAir® Installation Manual & OEM Off Road Supplement for Additional Safety Information

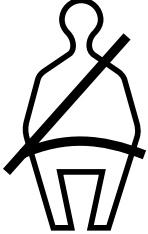

Affix warning decal on driver's side visor in clear view of all occupants.



WARNING:
This advanced AccuAir® JT kit requires professional installation, with access to vehicle lift and experience with Jeep JT suspension, electrical wiring, Jeep maintenance recommendations, safety messaging, torque & other specifications, general repair safety including personal protection, vehicle rack safety, isolation and containment of OEM spring assemblies during removal.



WARNING:
Incorrect shock length will distort air bag placement and lead to burst or reduced service life. USE front and rear shock absorbers included with this kit.
Replacement shocks must be FRONT: 26.125" (allowed variance .125"); REAR: 27.72" (allowed variance .125").



CAUTION:
Risk of Eye Injury. Safety glasses, gloves & other personnel protection should be worn when working with this product.



NOTICE:
Never lower vehicle from rack or following inspection/repair without air bags being fully inflated.

⚠ WARNING

CANCER AND REPRODUCTIVE HARM

WWW.P65WARNING.CA.GOV

- The drag link must be adjusted to center the steering wheel before the vehicle is driven. Failure to do so will cause computer errors, odd handling characteristics, and poor performance.
- If larger tires (10% more than the OEM diameter) are installed, speedometer recalibration will be necessary. Contact your local Jeep dealer.
- After installation, a qualified alignment facility is required to align the vehicle to the OEM specification.

If you have any questions or reservations about installing this product, contact AccuAir Customer Service.

WHAT IS COVERED?:

Subject to the terms, exclusions and limitations herein, Arnott, LLC. (“Warrantor” or “AccuAir”) exclusively warrants to the initial retail purchaser of a AccuAir Jeep JT suspension kit that AccuAir will according to terms herein, repair defects in or replace AccuAir supplied components which, upon AccuAir inspection are determined to have defects in materials or workmanship existing as of the date of sale to the initial retail customer (hereafter “Customer”). This Limited Warranty is the sole and exclusive warranty made or authorized by Warrantor. This Limited Warranty is not a warranty or promise of any particular future performance.

The term of this Limited Warranty shall be three years as measured from the date of sale to initial Customer (the warranty “TERM”). Any claim under this limited warranty must be made within six months of the last day of the warranty TERM or will be forever waived. The duration of any implied warranty shall be limited to the three year term of express limited warranty above.

WHAT IS NOT COVERED?:

Your AccuAir **Limited Warranty does not cover:** (1) defect in a AccuAir air suspension kit or component causing or contributing to damage or defect, of any type whatsoever, to the vehicle it is installed upon or any electrical system or other vehicle system or component separately warranted or supplied by a manufacturer other than AccuAir, (2) damage to AccuAir components or your vehicle from altering or disabling any component of your vehicle or AccuAir product; additions, alterations, or other products or components not supplied by AccuAir, (3) installation or use contrary to professional installation recommendations, or other installation/use contrary to instructions and safety messaging included within your AccuAir product, (4) expected wear and tear on airbags and other components considering vehicle use, damage related to failure to adequately, install, inspect, maintain, adjust or service as recommended or required, damage resulting from improper suspension set-up, loading, accident, collision, vandalism, abuse, misuse, neglect, fire, flood, normal wear, defects in or degradation of finishes, reflecting corrosion, UV or other environmental influences (5), AccuAir, components used in competition, other off road use or events which may involve unforeseen vehicle components, suspension set ups, contact between vehicles, rocks or obstacles, other components of your vehicle and your AccuAir components, damage or degradation of performance, (6) *labor, lost time, lost use or opportunities, reasonable delays in remedies hereunder, other consequential, incidental, punitive or other damages or costs, including those incurred in removing, reinstalling or delivering your AccuAir component to AccuAir for inspection, repair or replacement.*

OBTAINING WARRANTY & CUSTOMER SERVICE:

Register your AccuAir Purchase. For questions or claims contact AccuAir Customer Service: **100 Sea Ray Drive, Merritt Island, FL 32953.** You will be asked to advise AccuAir in writing of your understanding of all defects and provide AccuAir an opportunity to repair or replace the affected component(s) subject to the terms of this Limited Warranty. Please have proof of purchase available.

REMEDY LIMITED TO REPAIR/REPLACEMENT BY ACCUAIR. BINDING, SINGLE CLAIM ARBITRATION-VENUE:

Upon Customer’s removal and delivery to AccuAir for inspection and AccuAir determination of a covered defect, *the exclusive remedy provided hereunder* shall at AccuAir’s option be repair or replacement of the defective AccuAir component(s). Your sole and exclusive remedy for breach of this Limited Warranty or any implied warranty imposed by law, is the reasonable costs for replacement parts necessary to correct the defect(s) upon which the finding of breach is based. *For separate, valuable consideration received; all claims arising from or related to purchase or use of AccuAir components shall exclusively be maintained as a separate action by each Customer applying Florida state law*

(without reference to treaties or conflict of law provisions) through binding arbitration before a neutral selected by Customer from the JAMS® panel closest to Merritt Island, Florida. To the extent permitted by law, each party shall bear its own costs and fees. Any claim to enforce an arbitration award or for other breach or damages under this Limited Warranty can only be brought in a court of competent jurisdiction closest to Brevard County, Florida.

OTHER EXCLUSIONS –LIMITATION OF DAMAGES - YOUR RIGHTS UNDER STATE LAW.

No employee, other agent of AccuAir or authorized reseller may, amend or waive this written Limited Warranty or make additional representations or warranties regarding any AccuAir features, performance, workmanship or materials. AccuAir reserves the right to make changes in design and changes or improvements upon its products without imposing any obligation on itself to install or upgrade the same upon products previously manufactured.

By installation and use of your AccuAir product, and/or submitting a claim under this **Limited Warranty**, you acknowledge that you have received and understand all product instructions, warnings and this **Limited Warranty** and agree to be bound by all terms therein, reflecting the exclusive terms and remedies of the parties bargain.

*This **Limited Warranty** gives you specific rights. You may also have other rights that vary from state to state. For example, some states do not allow limitations of how long an implied warranty lasts and/or do not allow the exclusion or limitation of incidental or consequential damages, so the limitations and exclusions herein may not apply to you. All other warranties are hereby disclaimed, except to the extent prohibited by applicable law.*



INCLUDED PARTS

Air Suspension Conversion Kit	VIAIR Inflation System
JRi Custom Tuned Shocks	Front Lower Control Arms
e+ Connect	Rear Upper and Lower Control Arms
TouchPad+ Upgrade	Adjustable Front Track Bar
Height+	Front and Rear Sway Bar End Links
Height Sensor Brackets	Front and Rear Brake Line Extension Brackets
VU4 4-Corner Manifold	Install Kit for ECU, Air Tank, Compressor
3 Gallon Seamless Tank	Air Compressor Bracket
VIAIR 485C Compressor	

INDEX

Wire Termination Points, Fuse Box, Speed Module Routing & Plumbing Routing Diagrams	7
Wiring	15
Front Installation	28
Rear Installation	37
Troubleshooting & Technical Support	52
Final Clearance Check & Torque Steps	53

REQUIRED TOOLS

SAE & SAE Hex Key Sockets/Wrenches (5/32", 7/32" & 5/16" Hex Key Sockets, 7/16", 1/2", 9/16", 3/4", 13/16", 7/8" & 1-1/8")		Metric & Metric Hex Key Sockets/Wrenches (6mm Hex Key Socket, 8mm, 10mm, 13mm, 15mm, 18mm, 19mm, 21mm, 22mm & 24mm)	
Measuring Tape	Jack Stands	Ball Peen Hammer	Floor Jack
Safety Glasses	Pliers	Wheel Chock	Torque Wrench
Blue Loctite			

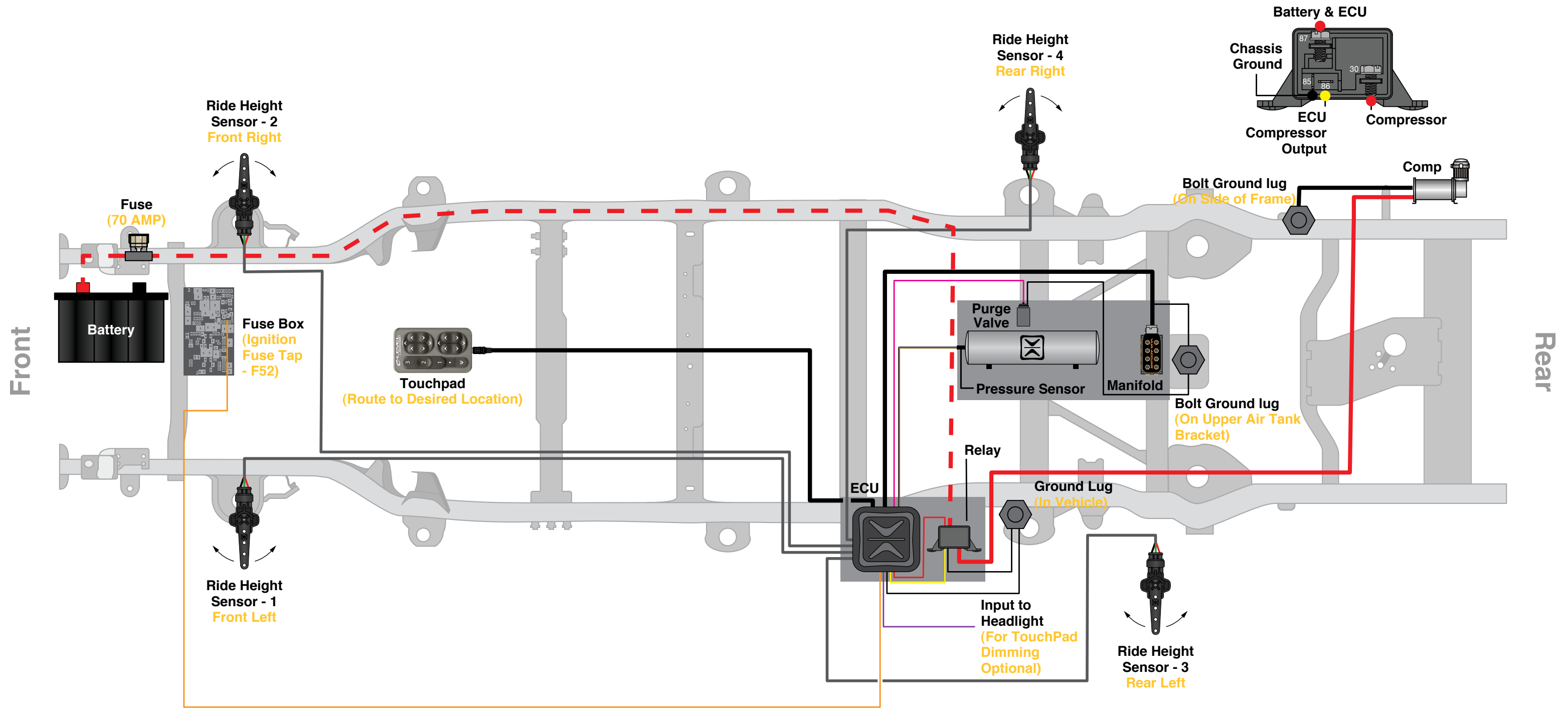

TAP INTO F52

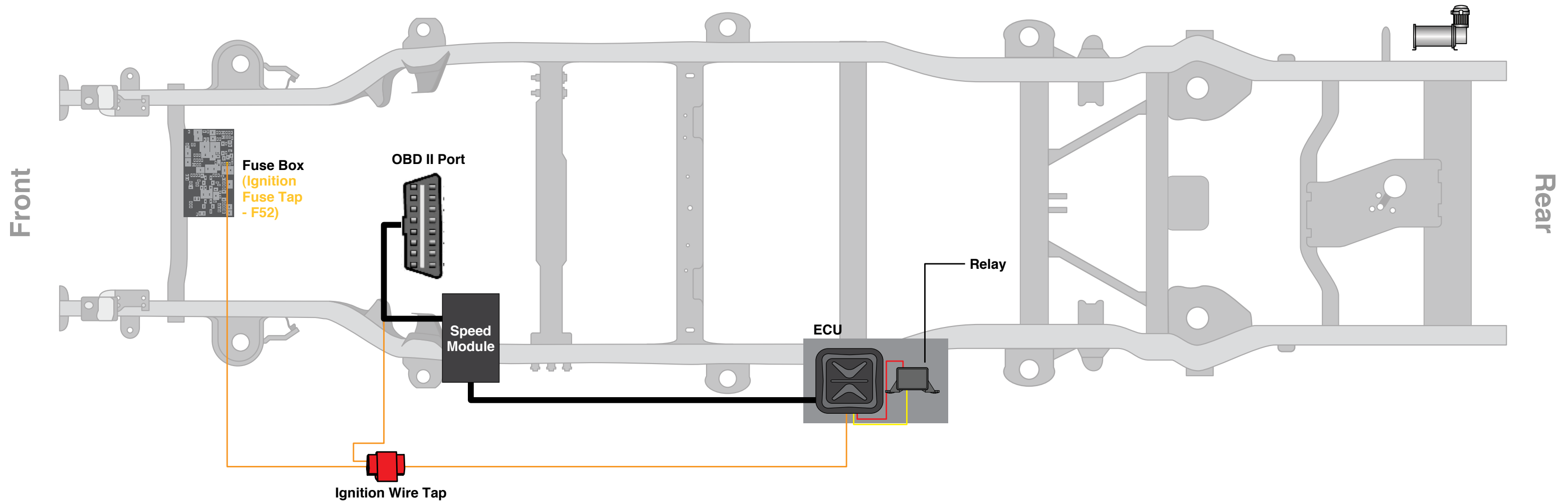

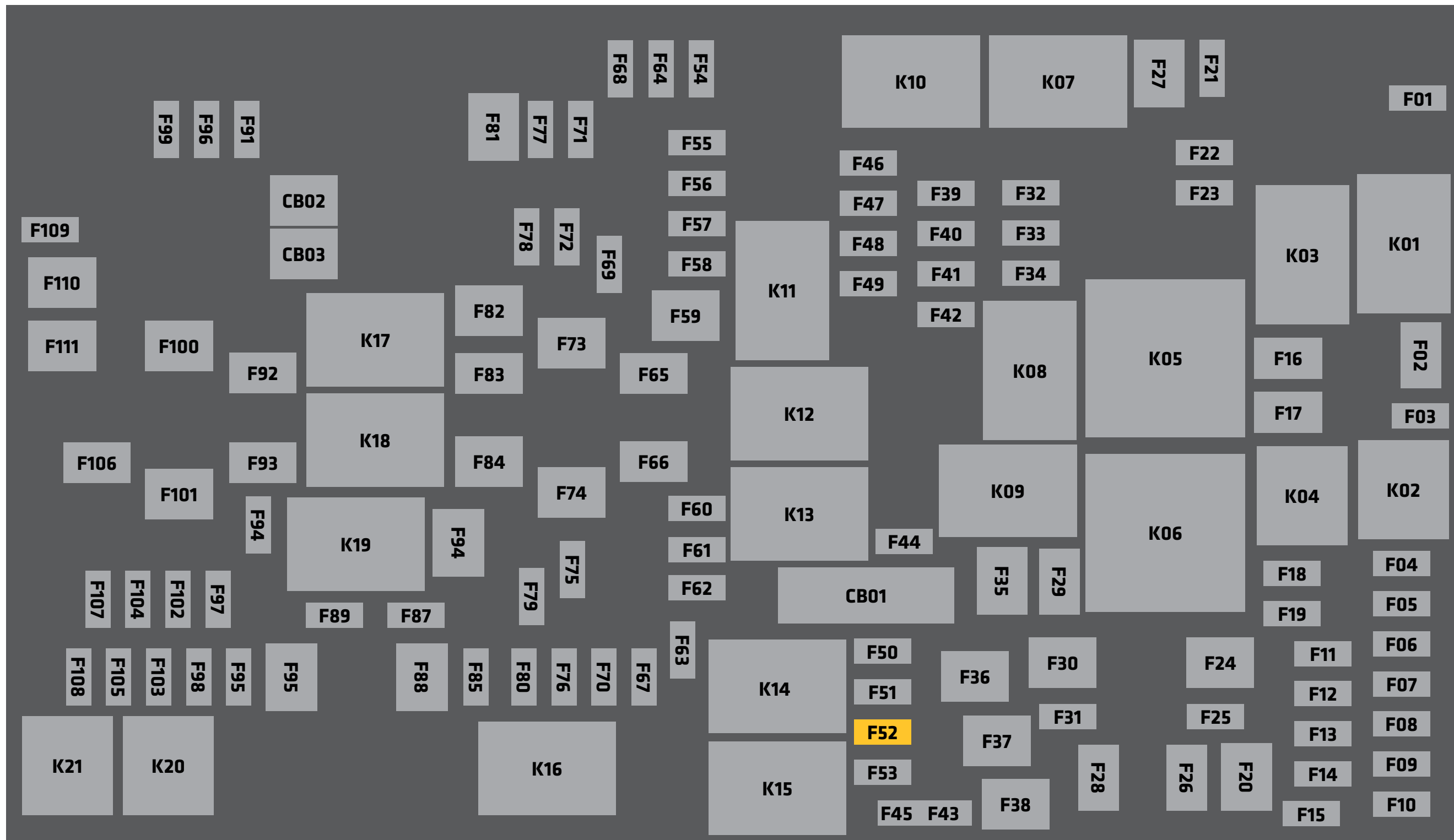

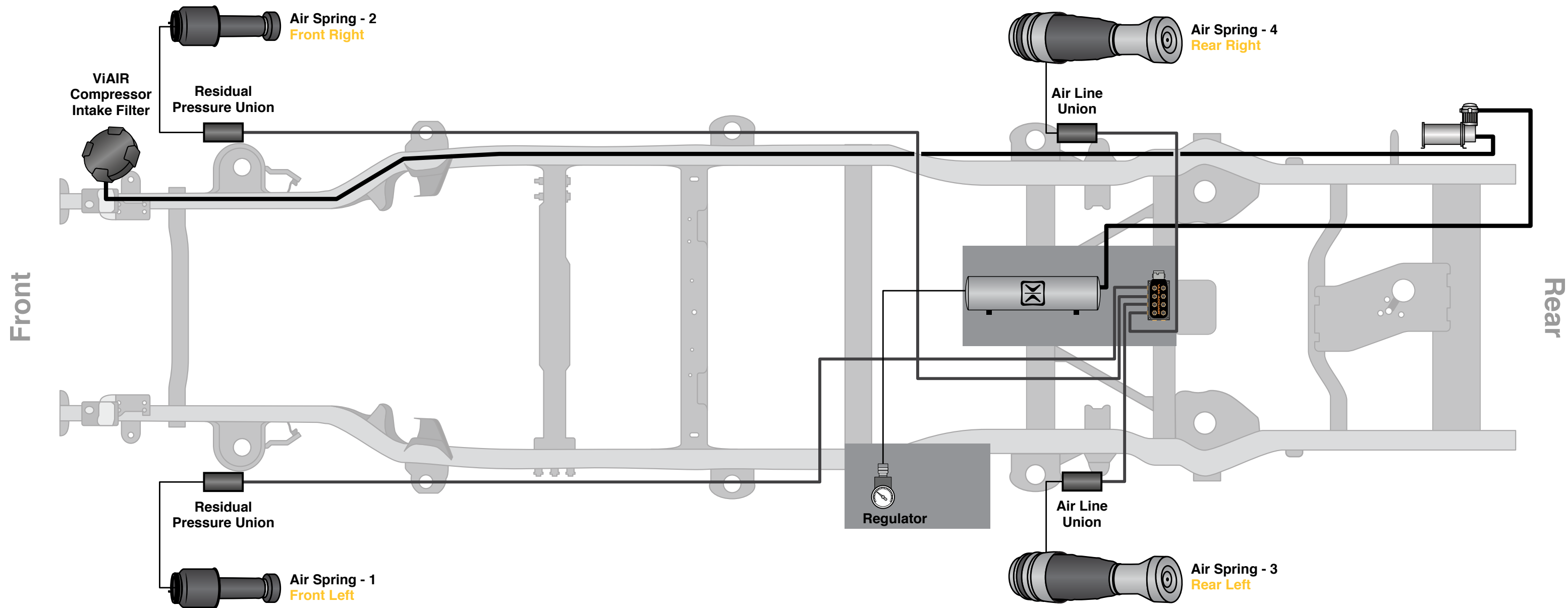



1. Remove plastic tray from under rear seat. Remove plastic bolt box under the driver rear seat. Fold carpet forward. (Figures 1, 2)



FIGURE 1



FIGURE 2

2. Locate the rubber plug in the floor located above the gas tank. Remove and install supplied grommet. (Figures 3, 4)



FIGURE 3



FIGURE 4

3. Take the 6 gauge power wire with the 70 AMP fuse installed. (Figure 5)
Lay the fuse on top of the battery and route remaining wire along the passenger side frame rail to the floor drain plug underneath the center of the vehicle. **Do not connect to battery at this time.**



FIGURE 5

- 4. Install the upper part of the air tank bracket with VU4 manifold attached. This spacer must be used when installing the bracket to prevent crushing the crossmember when it is fully tightened. (Figure 6)



FIGURE 6

- 5. Plug in the VU4 harness and run through the grommet in the floor to the inside of the cab. (Figures 9, 10)



FIGURE 9



FIGURE 10

Snug bolt. **Do not completely tighten at this time.** You will come back and tighten this bolt after the lower bracket is installed. (Figures 7, 8)



FIGURE 7



FIGURE 8



- 6. Run 3/8" tubing from the VU4 to all four spring locations. Run in a safe location away from heat and objects that will pinch or chafe the lines. (Figure 11)

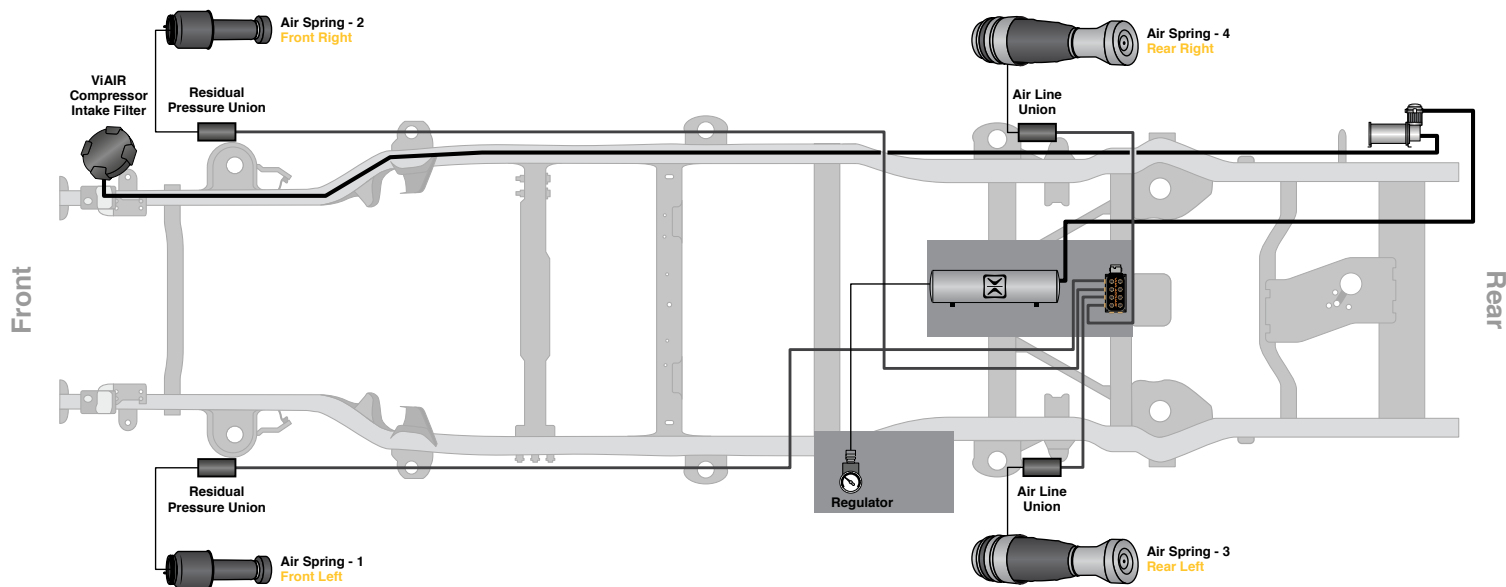

- 7. Start supplied bolts into existing threaded holes on passenger rear of frame. The bracket will slide over these bolts. Install the compressor bracket. Ensure the leader hose from the compressor is routed above the frame. (Figures 12, 13, 14)



FIGURE 12



FIGURE 13

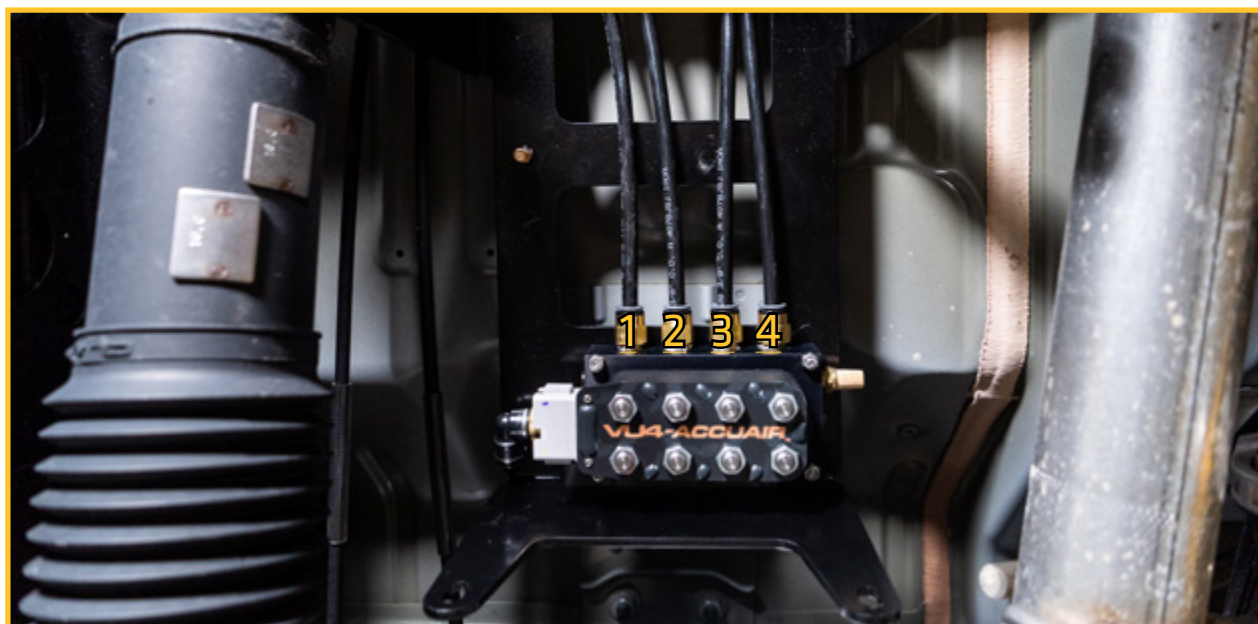

FIGURE 11



FIGURE 14

8. Ground the compressor to the frame using the factory bolt located in front of the compressor mounting location. (Figures 15, 16)



FIGURE 15



FIGURE 16

9. Run power from compressor to the inside of the cab through the rubber grommet in the floor. (Figure 17)



FIGURE 17

10. From inside the cab, run the tank pressure and dump plugs and wires through the grommet in the floor to the exterior of the Jeep. (Figure 18)

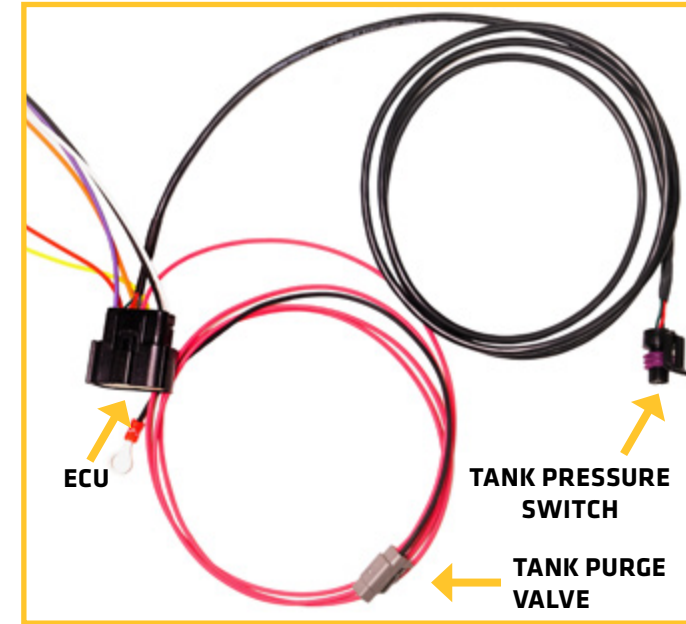

FIGURE 18

11. Install the lower tank bracket to the upper tank bracket using the supplied hardware. Two bolts in the front of the brackets utilize factory threaded holes in the transmission cross-member. (Figure 19, 20, 21)



FIGURE 19

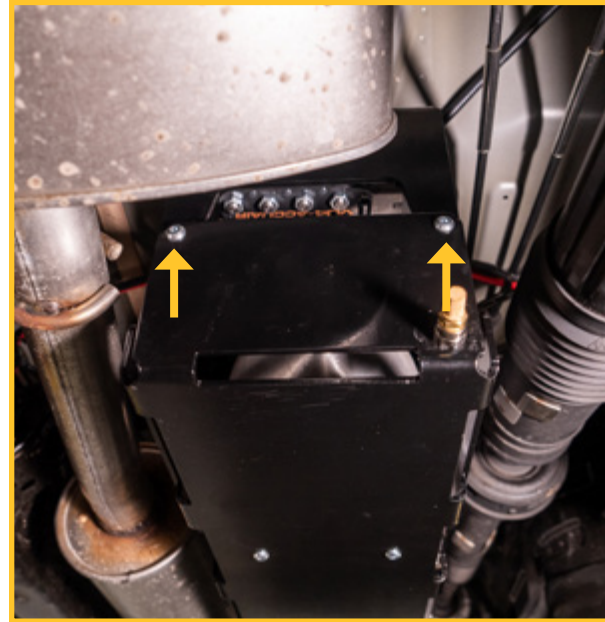

FIGURE 20



FIGURE 21

(USE BLUE LOCTITE WHEN INSTALLING THE M8 FASTENERS TO THE FACTORY CROSSMEMBER)

NOTE: Finish tightening the upper tank bracket mounting bolt at this time.

12. Plug in tank pressure sensor located on the front of the air tank. (Figure 22)



FIGURE 22

13. Plug in the tank purge valve. (Figure 23)



FIGURE 23



- 14. Ground the VU4 harness and purge valve to the stud located on the top bracket using supplied washer and Nyloc nut. (Figures 24, 25)

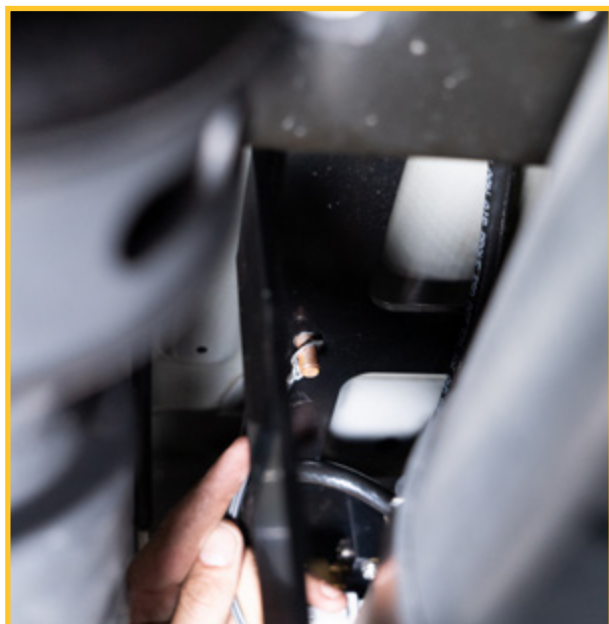

FIGURE 24

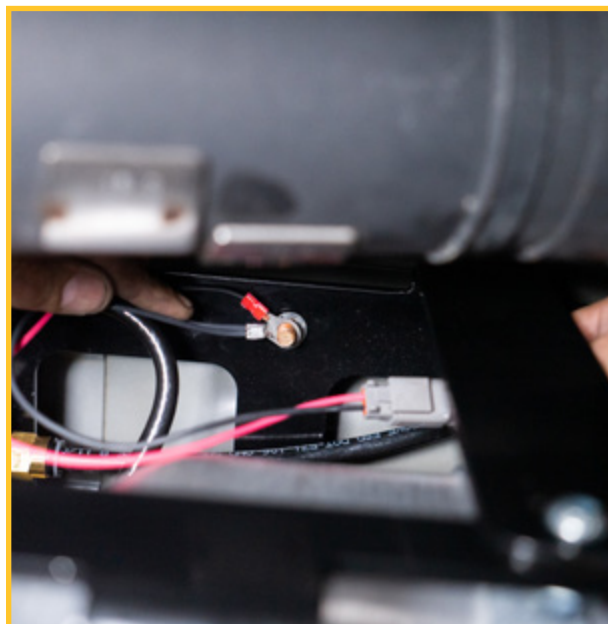

FIGURE 25

- 15. Run 3/8" tubing from VU4 supply to tank. (Figure 26)

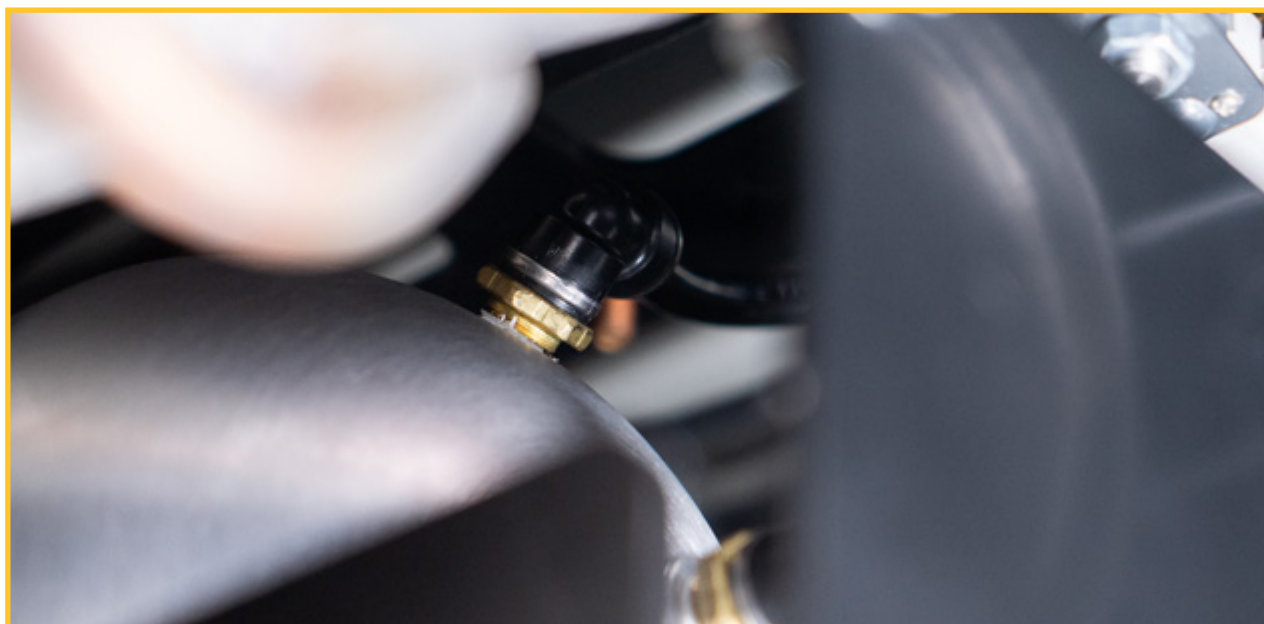

FIGURE 26

- 16. Run 3/8" tubing from PTC on the compressor leader hose to the air tank. (Figure 27)



FIGURE 27

- 17. Run the 3/8" tubing from the intake of the compressor to the air box area under the hood and install ViAIR compressor filter. (Figure 28)



FIGURE 28



18. Run 1/4" tubing from the front of the air tank through the rubber grommet inside the cab. (Figure 29)



FIGURE 29

1. With vehicle on flat level ground, set emergency brake & chock rear tires/wheels.
2. Raise front of vehicle. Support frame rails using jack stands at indicated lift points in OEM service manual.
3. Remove the front tires/wheels using a 22mm socket.
4. Remove OEM front sway bar end links using a 6mm hex key socket/wrench & 18mm socket/wrench. (Figure 30)



FIGURE 30

5. Disconnect OEM front track bar from frame using a 21mm socket/wrench. (Figure 31)

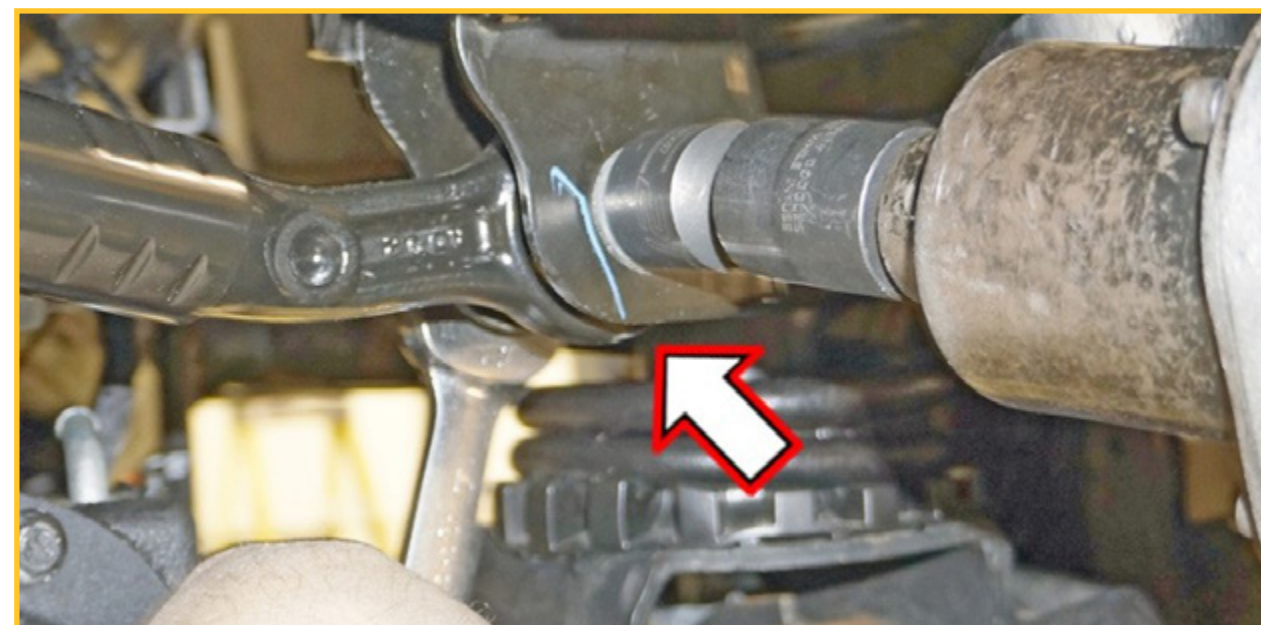

FIGURE 31



- 6. Disconnect OEM front shock from upper shock tower mount & lower axle mount using a 18mm socket/wrench. (Figure 32)

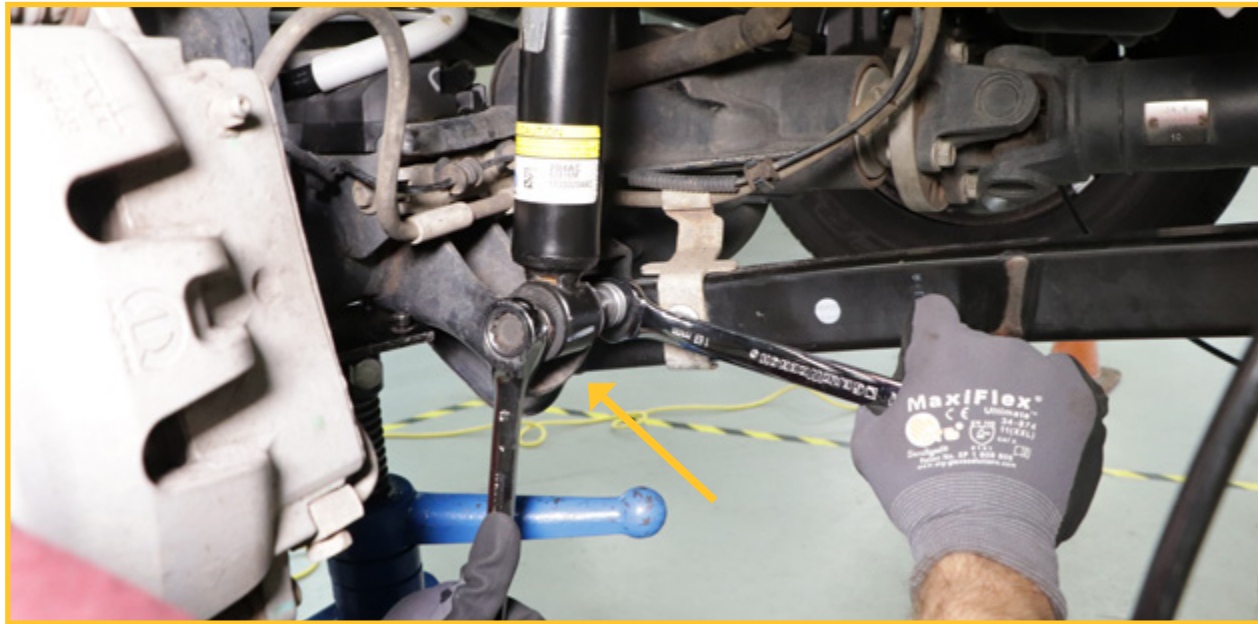

FIGURE 32

- 7. Disconnect OEM front brake line brackets from OEM front lower control arms using a 15mm socket/wrench. (Figure 33)



FIGURE 33

- 8. Disconnect wiring harness from passenger side OEM front upper control arm using pliers.
- 9. While checking for appropriate slack in ABS lines, brake lines, differential vent hose, etc, lower front differential & remove OEM front coil springs.
- 10. Remove the bump stop and upper/lower spring isolators. (Figures 34, 35, 36)

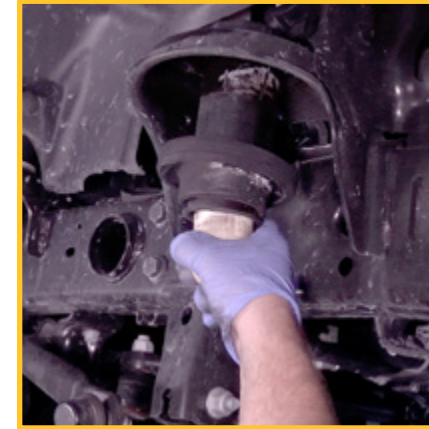

FIGURE 34

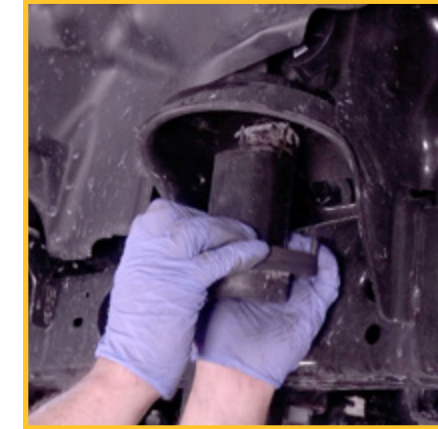

FIGURE 35



FIGURE 36

- 11. Attach air line from **AA-4391** to inside of air spring top. (Figures 37, 38)



FIGURE 37



FIGURE 38



12. Install the new air springs with the air line going through the top mount hole of the frame. (Figures 39, 40)

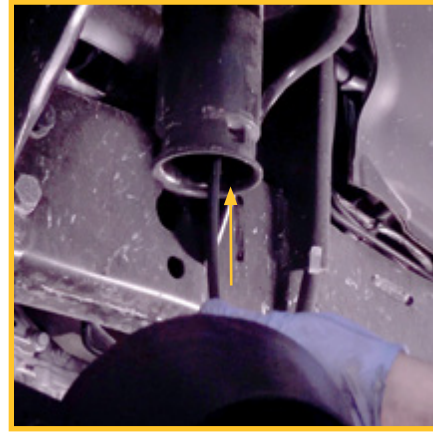

FIGURE 39



FIGURE 40

13. Install and tighten the top and bottom mount nuts on the air spring studs. Tighten to 17 ft-lbs. (Figures 41, 42)



FIGURE 41

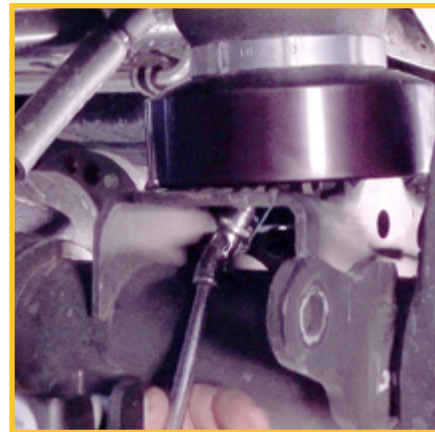

FIGURE 42

14. Install top cap with the air line passing through the center. Seat the cap on the top mount. (Figures 43, 44)



FIGURE 43



FIGURE 44

15. One at a time, remove the OEM front lower control arms & install the new front lower control arms using the OEM hardware, a 21mm socket/wrench, & 24mm socket/wrench.

NOTE: Install the new front lower control arms with the offset bend toward the inside of the vehicle.

AIR SPRING PLUMBING

16. Using the residual pressure union, connect the 1/4" air line from the air spring and 3/8" air line from the VU4. (Figure 45)



FIGURE 45



FRONT RIDE HEIGHT SENSOR INSTALLATION

17. Install the front ride height sensor bracket assembly on the vehicle. The bracket will slide under the heat shield and attach to the frame using the same bolt for the heat shield. The provided nut will be installed to the back of this heat shield bolt. Tighten to 65 in-lbs. Interlock the upper tab of the sensor bracket into the cutout on the upper control arm mount. (Figures 46, 47)

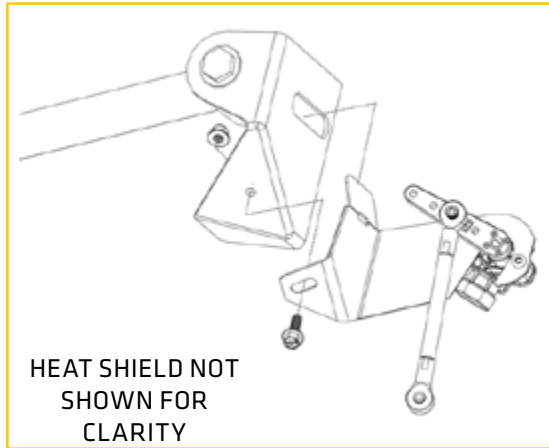

FIGURE 46 - RIGHT FRONT

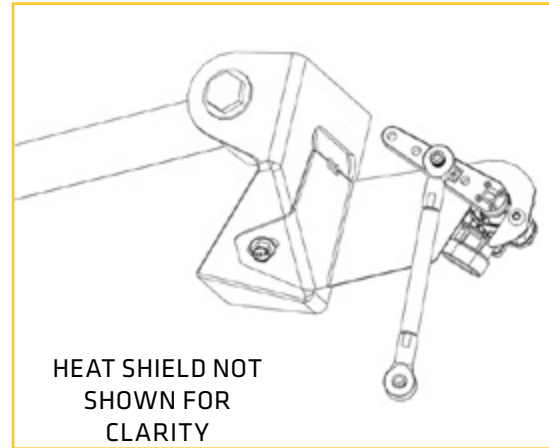

FIGURE 47 - RIGHT FRONT

18. When installed it should look as shown. (Mount link to lower control arm.) (Figure 49)



FIGURE 48



NOTICE:

If lowering vehicle before moving onto rear installation, front air springs **MUST** be inflated. Failure to inflate will cause air spring damage.

19. Install Front Brake Line Bracket to front lower control arm with OEM hardware using a 15mm socket/wrench. (Figure 49)
Connect OEM front brake line bracket to bracket using supplied 1/4" x 1" Fine Thread Bolt with 1/4" SAE Washer outside & 1/4" SAE Washer with 1/4" Nylon Insert Lock Nut on inside with a 7/16" socket/wrench.



FIGURE 50

20. Install JRi front shock with OEM hardware at upper shock tower mount using a 18mm socket/wrench. Connect JRi shock at lower axle mount with OEM hardware using a 18mm socket/wrench. Secure, but **do not completely tighten** at this time. To set bushings properly for ride height, these will be tightened once vehicle is on ground with full vehicle weight on tires/wheels.

NOTE: JRi shocks are monotubes and designed to be mounted with cylinder body up for proper installation of pre-installed upper mount bushings.

21. Install front tires/wheels using a 22mm socket Lower vehicle to ground. Torque 130 ft-lbs.



FRONT INSTALLATION

22. Make sure that tires/wheels are pointed straight ahead. Install fixed end of Front Adjustable Track Bar to frame with OEM hardware using a 21mm socket/wrench. (Figure 52)

NOTE: Do not tighten at this time.

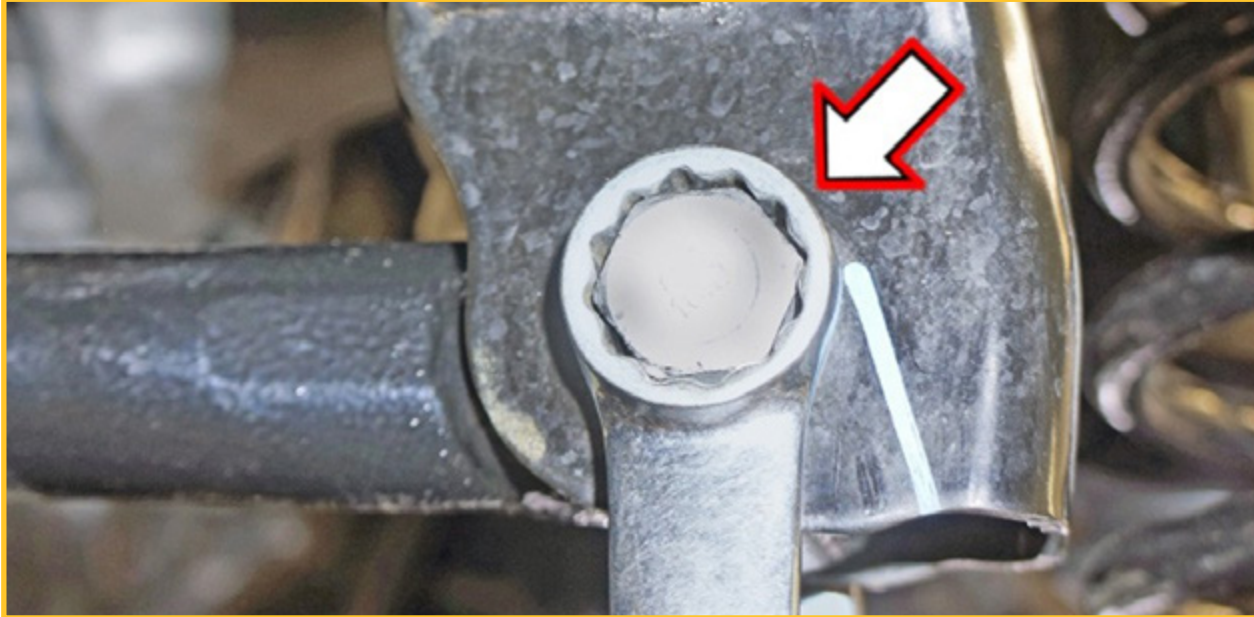

FIGURE 52

23. Install supplied Rod End Bushings onto rod end of track bar. Install rod end assembly into front axle mount with OEM hardware using a 21mm socket/wrench. (Figure 53)

NOTE: Do not tighten at this time.

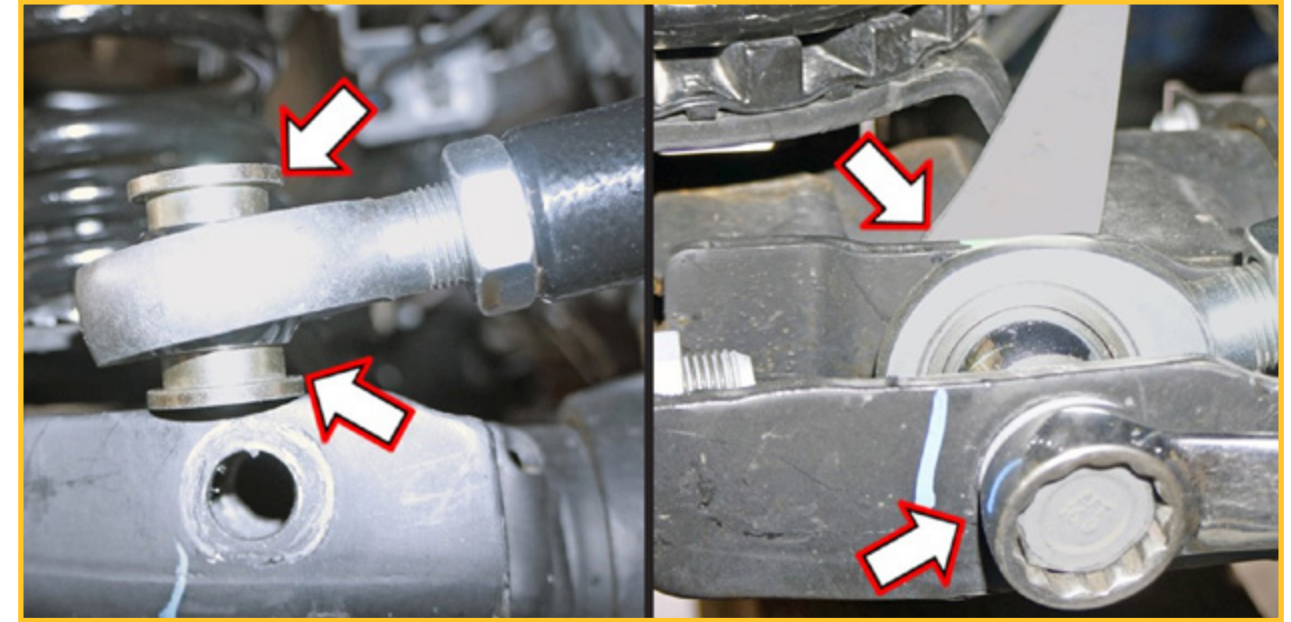

FIGURE 53

24. Install new front sway bar end links.

NOTE: It may be necessary to turn steering wheel to align track rod end with mount.

Check front of vehicle to make sure body is centered over front tires/wheels. Using a measuring tape, measure from inside of tire to frame on driver side. Then measure passenger side. Compare two measurements; the aim is to make both sides equal.

NOTE: If driver side measurement is greater than passenger side, track bar needs to be lengthened. If passenger side measurement is greater than driver side, track bar needs to be shortened.

Remove adjustable rod end of track bar, loosen jam nut using a 1-1/8" wrench & turn rod end to adjust in or out. Once body is properly aligned over front tires/wheels, tighten OEM hardware using a 21mm socket/wrench. Fully tighten all OEM hardware at upper frame mount & axle mount. Fully tighten jam nut of adjustable front track bar using a 1-1/8" wrench.



REAR INSTALLATION

1. Disconnect both rear sway bar links from chassis and sway bar. (Figures 55, 56)



FIGURE 55



FIGURE 56

2. To gain access to the upper shock bolts, the fender liner can be pulled back to allow a wrench to loosen the shock. (Figure 54)



FIGURE 54

3. Remove factory shocks. This will allow the rear axle to droop enough to remove the factory coil springs. (Figures 57, 58)



FIGURE 58



FIGURE 59

4. Lower the rear axle and remove the rear coil springs and rubber spring isolators. (Figures 59, 60)



FIGURE 59



FIGURE 60



5. Install the new JRI Shocks. (Figures 61, 62)



FIGURE 61



FIGURE 62



FIGURE 65



FIGURE 66

6. One at a time, remove and replace the rear arms, starting with the upper arms first. (Figures 63, 64, 65, 66, 67, 68, 69, 70)



FIGURE 63



FIGURE 64



FIGURE 67



FIGURE 68



FIGURE 69



FIGURE 70

- 7. On the upper arms, you will need to install the height sensor bracket while installing the upper link bar bolt on the frame. Ensure the locating tabs on the height sensor bracket are sitting against the mount. When installing the upper link bar, the welded tab for height sensor linkage should be on top and towards the frame. (Figure 71)



FIGURE 71

- 8. After you finish installing all four rear arms, connect the rear height sensor linkage to the upper arm using the supplied hardware and spacer. (Figures 72, 73)



FIGURE 72



FIGURE 73

- 9. From the inside of the cab, feed all four height sensor plugs through the grommet and route to corresponding height sensors. (Figures 74, 75)

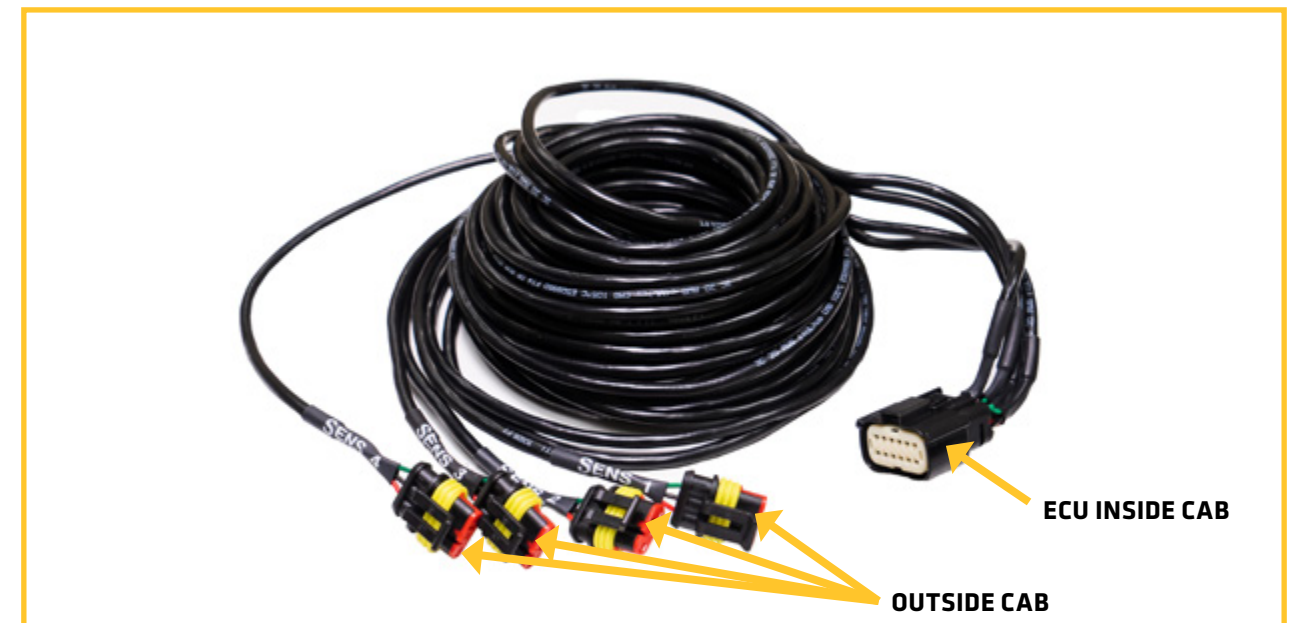

FIGURE 74



NOTE: Store excess wire inside of cab.

10. Install new rear air springs by inserting the locating tab inside the hole on the lower perch and rotating the bag to the rear of the vehicle. Ensure locating tabs are on the outside of this bracket (towards center of the axle). (Figures 76, 77, 78, 79)



FIGURE 75



FIGURE 76



FIGURE 77



FIGURE 78



FIGURE 79



11. Connect the 1/4" air line supplied to the top of the air spring. Then push the top of the air spring into the factory spring pocket and install the retaining clip as pictured. (Figures 80, 81, 82)



FIGURE 80



FIGURE 81



FIGURE 82

12. Route the 1/4" line to meet the 3/8" line from the VU4 and connect using supplied fitting. (Figure 83)

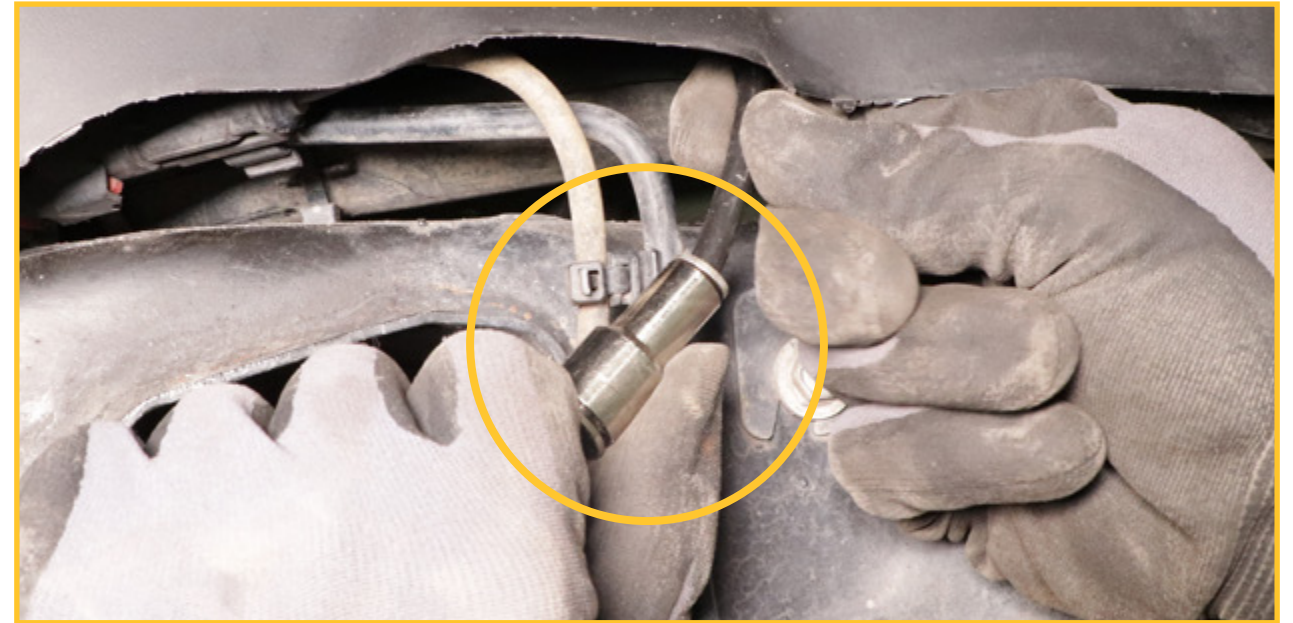

FIGURE 83

13. Install new rear sway bar end links.
14. Install supplied grease cerk on both ends of each end link.
15. Install the track bar relocation bracket to the rear axle using the supplied hardware and spacers through the factory mounting hole. (Figures 84, 85)



FIGURE 84



FIGURE 85



with Nyloc washers. At this time, you can reinstall the track bar to the new mounting location. (Figures 86, 87)



FIGURE 86



FIGURE 87

17. Install the rear bump stop extensions using supplied hardware. (Figures 88, 89)



FIGURE 88



FIGURE 89

18. Inside the cab, route the VU4 harness, 12V power supply, height sensor, compressor power, and ECU main plug to the drivers side and through the factory carpet cutout as pictured. (Figure 90)

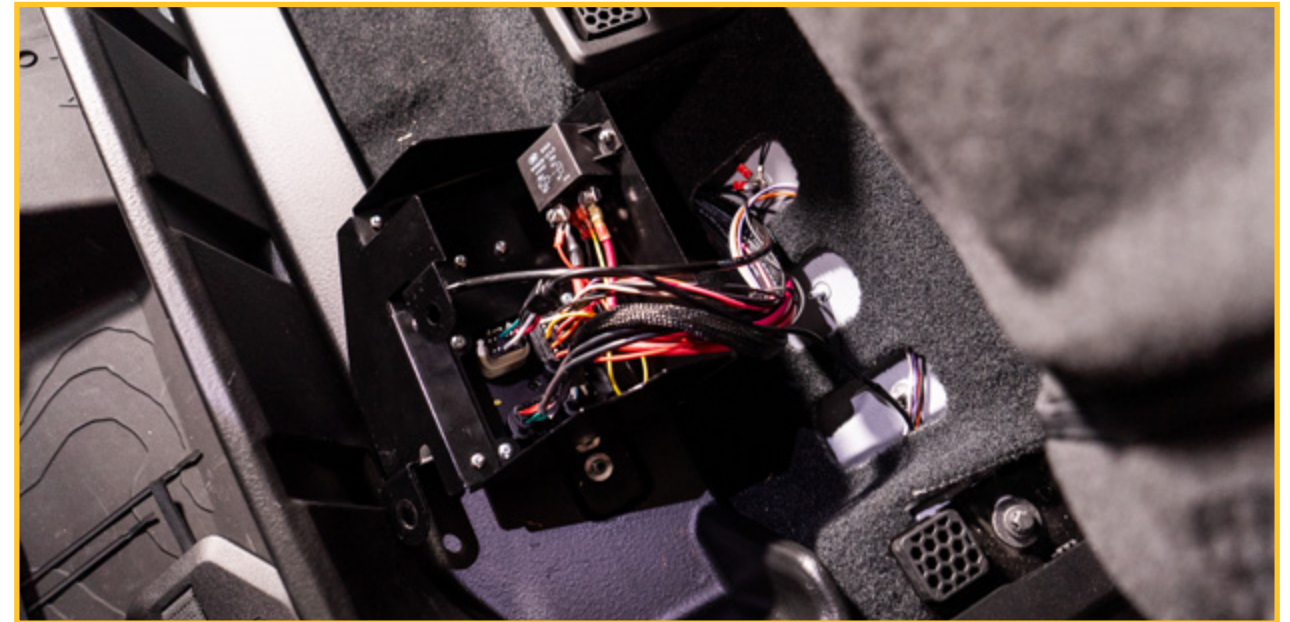

FIGURE 90

19. Make all connections to the ECU and compressor relay. Route the orange, purple speed module wire and TouchPad harness to the drivers side lower kick panel. (Figure 91)

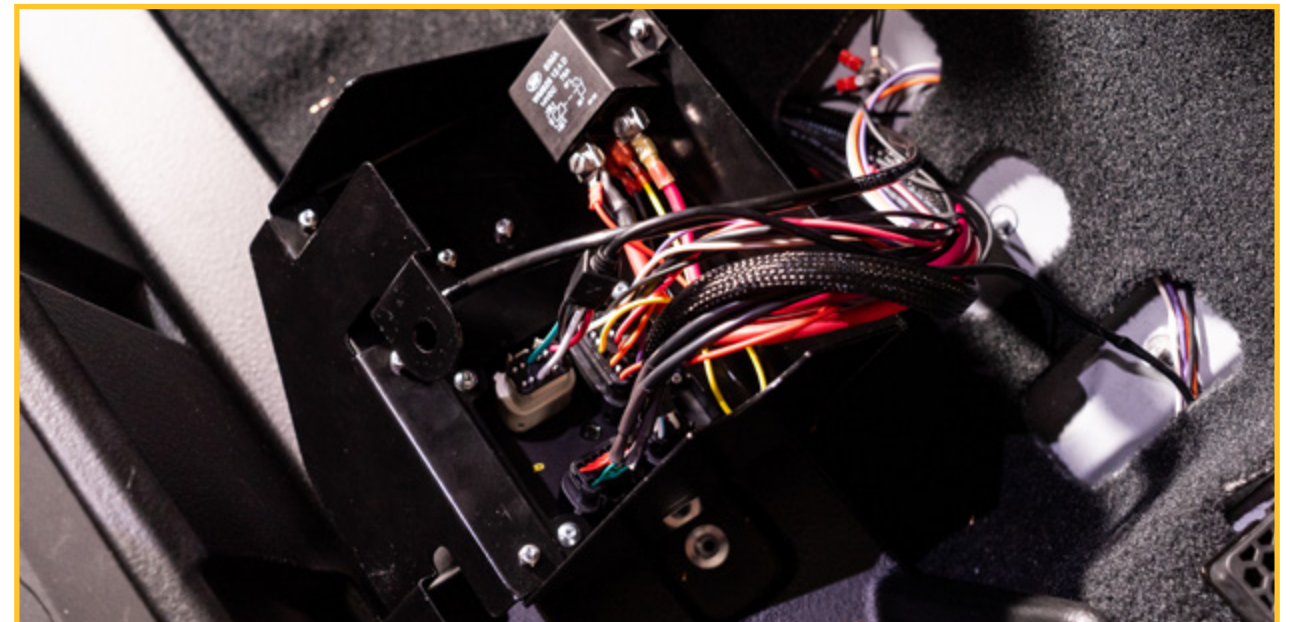

FIGURE 91



20. There will be three grounds, one from the ECU, one from the speed control module and one from the compressor relay. They will go on the stud as pictured. (Figure 92)



FIGURE 92

22. Replace the plastic tray. The ECU bracket utilizes two of the factory mounting points on the drivers side. (Figures 94, 95)



FIGURE 94



FIGURE 95

21. Connect 1/4" tubing from the air tank to the PTC fitting on the regulator for the inflation system. (Figure 93)



FIGURE 93

23. Replace the bolt storage bin behind the ECU bracket. Make sure both grounds are still in position before tightening. (Figures 96, 97)



FIGURE 96



FIGURE 97



- Route the orange ignition-on wire to the fuse box located under the hood and connect to fuse 52 using the supplied fuse splice. Crimp and make battery connection for the main power wire and install the 70 AMP fuse. (Figures 98, 99)



FIGURE 98



FIGURE 99

- Install the speed module using hardware from the box labeled **AA-4103**. The supplied speed module must be installed to allow full functionality of the system. View video using QR code to the right for installation process.



SPEED MODULE VIDEO

- Start vehicle. Make sure there are no dash lights pertaining to suspension.
- Bounce the vehicle a couple of times. This will help suspension settle to new ride height. Cycle steering lock-to-lock & check all components for proper operation & clearances. Pay special attention to clearance between tires/wheels, Shocks, control arms, brake hoses, ABS wiring, etc.
- Front Tighten & Torque Sequence.
 - Track bar at frame using a 21mm wrench. Torque 52 ft-lbs.
 - Track bar at axle using a 21mm wrench. Torque 52 ft-lbs.
 - Front shock absorber upper mount using a 18mm wrench. Torque 81 ft-lbs. Front shock absorber lower mount using a 18mm wrench. Torque 74 ft-lbs.
 - Sway bar end link upper bolt using a 19mm socket/wrench. Torque 59 ft-lbs.
 - Sway bar end link lower bolt using a 18mm socket/wrench. Torque 59 ft-lbs.
- Rear Tighten & Torque Sequence.
 - Track bar bracket bolts. 1/2" Bolts Torque 90 ft-lbs. 9/16" Bolt Torque 130 ft-lbs.
 - Track bar at the bracket. Torque 130 ft-lbs.
 - Rear shock absorber upper mount using a 18mm socket/wrench. Torque 81 ft-lbs. Rear shock absorber lower mount using a 18mm socket/wrench. Torque 74 ft-lbs.
 - ADX Reservoir clamp. Double check position & clearance. Tighten with 5/32" Hex Key socket.
 - Sway bar end link mount using a 18mm socket/wrench. Torque 59 ft-lbs.

CHECK FOR SYSTEM LEAKS

Place all 4 wheels on the ground and inflate air springs with the TouchPad. Check for system leaks using soapy water on all pneumatic connections to the air springs and the regulator.



CALIBRATION VIDEO

CALIBRATION

Once system installation is complete, the system will need to be calibrated. Calibration is a process that will learn the vehicle range of travel and automatically set ride heights.

The vehicle needs to be on level ground with the wheels pointed straight ahead. Leave the vehicle running to power the compressor(s) during this procedure.

Before starting calibration, turn on the vehicle and let the compressors run to fill the tank. Once the compressor stops running (green "C" on TouchPad stops blinking) you may simultaneously hold the "dot" and "1" button for 5 seconds. You may let go when the vehicle starts to move up.

The vehicle will now open the valves to the air springs and run the compressor to fill all air springs. The system will continue doing this until the set pressure is achieved at which

point the maximum suspension travel will be defined.

Next, the vehicle will exhaust all air from the air springs to define the minimum travel.

Calibration is complete when the system prompts a position 2 two adjustment ("2" will be flashing on the TouchPad). This may take some time as the system has to fill the tank and air springs from near empty.



WARNING:

The system will automatically **raise/lower** the vehicle in the next procedure. Remove all obstructions and keep clear of vehicle before proceeding.

FINAL NOTES

After installation is complete, double check that all nuts & bolts are tight. Refer to the following chart for proper torque specifications.

NOTE: Do not re-tighten nuts & bolts where thread lock compound was used.

With vehicle placed on ground, cycle steering lock to lock & inspect steering, suspension, brake lines, front & rear drive lines, fuel lines & wiring harnesses for proper operation, tightness & adequate clearance.

Have headlights readjusted to proper settings.

Have a qualified alignment center align vehicle to OEM specifications.

After first 100 miles, check all hardware for proper torque & periodically thereafter.

TORQUE SPECIFICATIONS					
INCH SYSTEM			METRIC SYSTEM		
Bolt Size	Grade 5	Grade 8	Bolt Size	Class 8.8	Class 10.9
5/16	180 in-lbs	240 in-lbs	6MM	60 in-lbs	108 in-lbs
3/8	30 ft-lbs	35 ft-lbs	8MM	216 in-lbs	23 ft-lbs
7/16	45 ft-lbs	60 ft-lbs	10MM	32 ft-lbs	45 ft-lbs
1/2	65 ft-lbs	90 ft-lbs	12MM	55 ft-lbs	75 ft-lbs
9/16	95 ft-lbs	130 ft-lbs	14MM	85 ft-lbs	120 ft-lbs
5/8	135 ft-lbs	175 ft-lbs	16MM	130 ft-lbs	165 ft-lbs
3/4	185 ft-lbs	280 ft-lbs	18MM	170 ft-lbs	240 ft-lbs

THE ABOVE SPECIFICATIONS ARE NOT TO BE USED WHEN THE BOLT IS BEING INSTALLED WITH A BUSHING.

COLDER CLIMATE TIPS

In the winter months, to keep your air system from freezing, we recommend adding CRC air brake antifreeze. This can be purchased at most automotive parts houses. We recommend that you add two caps (about 1 ounce) to the system through the compressor intake. To do this, you should adjust the suspension to deplete the air in the tank so the compressor will be running while you do this process. You want to slowly add the antifreeze to the system so it has time to vaporize and coat everything. You will need to do this periodically depending on how much use the vehicle has. Generally, once every two weeks will but can vary.

TROUBLESHOOTING & TECHNICAL SUPPORT

**MORE INFO?
ACCUAIR DOCUMENT LIBRARY**



PHONE: 833-247-3696



ACCUAIR



www.AccuAir.com | 833.247.3696
200 Sea Ray Drive, Merritt Island, FL 32953