

AA-5157

2020-PRESENT

JEEP GLADIATOR (JT, MOJAVE)

AIR SUSPENSION SYSTEM
INSTALLATION GUIDE





Product & Installation Overview	2
AccuAir® Suspension Limited Warranty	5
Included Parts	7
Required Tools	8
Wire Termination Points, Fuse Box, Speed Module Routing & Plumbing Routing Diagrams	9
Wiring	17
Front Installation	45
Rear Installation	63
Final Clearance Check & Torque Steps	75
Parts Appendix	77
Troubleshooting & Technical Support	Back Cover



WARNING:

Alignment must be performed at POSITION 2 immediately after installation.



NOTICE TO THE INSTALLER:

This suspension kit is installed differently than most suspension kits. We will have you install electrical and airlines first. Then you will install suspension system parts.



CONGRATULATIONS!

Your AccuAir® Jeep JT Air Suspension system reflects a unique solution to balancing enhanced off road terrain and obstacle clearance with everyday drivability and ride quality. The AccuAir® JT system features remote mounted seamless air tank, a quality compressor, mounts, and all fittings necessary to replace your coil springs with ruggedly designed four corner air bags allowing you to select a ride height tailored to your off road adventures. Back on the road, a unique speed sensing value presets ride height to a maximum of 4.0” of lift (approx.), helping to preserve familiar ride comfort. Enjoy your AccuAir® JT system by Treading Lightly® and following all instructions and product safety messaging below. If you have further questions contact us at: sales@AccuAir.com. Our team is here to help.

A FEW WORDS ABOUT PRODUCT SAFETY

Before installation, please take a moment to review the following safety information and installation instructions. Important safety information is generally preceded by one of three signal words indicating the relative risk of injury.

The signal words mean:



WARNING:

A hazardous situation which, if not avoided, could result in death or serious injury. You **CAN** be **killed** or **seriously hurt** if you don't follow instructions.



CAUTION:

A hazardous situation which, if not avoided, could result in minor or moderate injury. You **CAN** be moderately **hurt** and may also suffer property damage if you do not follow instructions.



NOTICE:

Careful attention is required to this instruction or operation but does generally not relate to personal injury. Damage to your AccuAir® product or other property may result if you don't follow instructions.



PRODUCT & INSTALLATION OVERVIEW

The suspension of this vehicle has been optimized for off road utility through installation of an AccuAir® system allowing control/adjustment of ride height to accommodate challenging terrain & obstacles. The suspension feel and handling may be different than an unmodified Jeep.

To reduce risk of roll-over other accident & serious injury always:

- Inspect components including bags, lines, valves & compressor before use, followed by system self-test. Maintain & repair as indicated. On road height limited to approx. 4.0" by system speed & ride height sensors. **REPLACE & DO NOT USE ON ROAD IF SPEED SENSOR DAMAGED/INOPERATIVE.**
- **DO NOT** modify or substitute AccuAir® components of this system. Use of oversize tire/wheel combinations may increase stopping distances, ride height and/or compromise performance of vehicle stability control and other systems.
- Avoid excessive speeds, abrupt maneuvers, surfaces/obstacles which may induce a tipping moment. All occupants **BUCKLE UP & USE** supplemental restraints.
- Consult the AccuAir® installation manual (sales@AccuAir.com) & OEM off road supplement for additional safety information.

WARNING: SUSPENSION MODIFIED WITH VARIABLE HEIGHT AIRBAGS - HIGHER ROLLOVER RISK

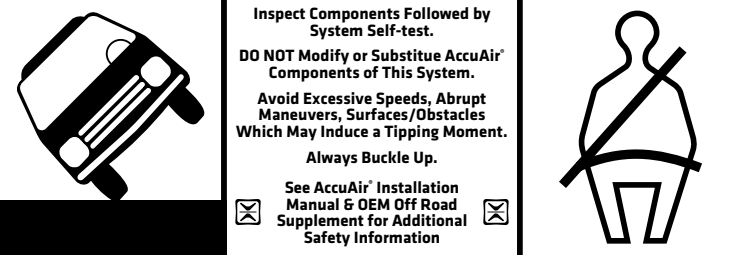

Inspect Components Followed by System Self-test.
DO NOT Modify or Substitute AccuAir® Components of This System.
 Avoid Excessive Speeds, Abrupt Maneuvers, Surfaces/Obstacles Which May Induce a Tipping Moment.
 Always Buckle Up.
 See AccuAir® Installation Manual & OEM Off Road Supplement for Additional Safety Information

Affix warning decal on driver's side visor in clear view of all occupants.



WARNING:

This advanced AccuAir® JT kit requires professional installation with access to a two-post vehicle lift. Experience with Jeep JT suspension, electrical wiring, Jeep maintenance recommendations, safety messaging, torque & other specifications, general repair safety including personal protection, vehicle rack safety, isolation and containment of OEM spring assemblies during removal will also be necessary.



WARNING:

Incorrect shock length will distort air bag placement and lead to burst or reduced service life. **ONLY** use front and rear shock absorbers included with this kit.



CAUTION:

Risk of Eye Injury. Safety glasses, gloves & other personnel protection should be worn when working with this product.



NOTICE:

Never lower vehicle from rack or following inspection/repair without air bags being fully inflated.



WARNING

CANCER AND REPRODUCTIVE HARM
WWW.P65WARNING.CA.GOV

- The drag link must be adjusted to center the steering wheel before the vehicle is driven. Failure to do so will cause computer errors, odd handling characteristics, and poor performance.
- If larger tires (10% more than the OEM diameter) are installed, speedometer recalibration will be necessary. Contact your local Jeep dealer.
- After installation, a qualified alignment facility is required to align the vehicle to the OEM specification.

If you have any questions or reservations about installing this product, contact AccuAir Customer Service.



ACCUAIR® SUSPENSION LIMITED WARRANTY

WHAT IS COVERED?:

Subject to the terms, exclusions and limitations herein, Arnott, LLC. (“Warrantor” or “AccuAir”) exclusively warrants to the initial retail purchaser of a AccuAir Jeep JT suspension kit that AccuAir will according to terms herein, repair defects in or replace AccuAir supplied components which, upon AccuAir inspection are determined to have defects in materials or workmanship existing as of the date of sale to the initial retail customer (hereafter “Customer”). This Limited Warranty is the sole and exclusive warranty made or authorized by Warrantor. This Limited Warranty is not a warranty or promise of any particular future performance.

The term of this Limited Warranty shall be three years as measured from the date of sale to initial Customer (the warranty “TERM”). Any claim under this limited warranty must be made within six months of the last day of the warranty TERM or will be forever waived. The duration of any implied warranty shall be limited to the three year term of express limited warranty above.

WHAT IS NOT COVERED?:

Your AccuAir **Limited Warranty does not cover:** (1) defect in a AccuAir air suspension kit or component causing or contributing to damage or defect, of any type whatsoever, to the vehicle it is installed upon or any electrical system or other vehicle system or component separately warranted or supplied by a manufacturer other than AccuAir, (2) damage to AccuAir components or your vehicle from altering or disabling any component of your vehicle or AccuAir product; additions, alterations, or other products or components not supplied by AccuAir, (3) installation or use contrary to professional installation recommendations, or other installation/use contrary to instructions and safety messaging included within your AccuAir product, (4) expected wear and tear on airbags and other components considering vehicle use, damage related to failure to adequately, install, inspect, maintain, adjust or service as recommended or required, damage resulting from improper suspension set-up, loading, accident, collision, vandalism, abuse, misuse, neglect, fire, flood, normal wear, defects in or degradation of finishes, reflecting corrosion, UV or other environmental influences (5), AccuAir, components used in competition, other off road use or events which may involve unforeseen vehicle components, suspension set ups, contact between vehicles, rocks or obstacles, other components of your vehicle and your AccuAir components, damage or degradation of performance, (6) *labor, lost time, lost use or opportunities, reasonable delays in remedies hereunder, other consequential, incidental, punitive or other damages or costs, including those incurred in removing, reinstalling or delivering your AccuAir component to AccuAir for inspection, repair or replacement.*

OBTAINING WARRANTY & CUSTOMER SERVICE:

Register your AccuAir Purchase. For questions or claims contact AccuAir Customer Service: **100 Sea Ray Drive, Merritt Island, FL 32953.** You will be asked to advise AccuAir in writing of your understanding of all defects and provide AccuAir an opportunity to repair or replace the affected component(s) subject to the terms of this Limited Warranty. Please have proof of purchase available.

REMEDY LIMITED TO REPAIR/REPLACEMENT BY ACCUAIR. BINDING, SINGLE CLAIM ARBITRATION-VENUE:

Upon Customer’s removal and delivery to AccuAir for inspection and AccuAir determination of a covered defect, *the exclusive remedy provided hereunder shall at AccuAir’s option be repair or replacement of the defective AccuAir component(s).* Your sole and exclusive remedy for breach of this Limited Warranty or any implied warranty imposed by law, is the reasonable costs for replacement parts necessary to correct the defect(s) upon which the finding of breach is based. *For separate, valuable consideration received; all claims arising from or related to purchase or use of AccuAir components shall exclusively be maintained as a separate action by each Customer applying Florida state law*

(without reference to treaties or conflict of law provisions) through binding arbitration before a neutral selected by Customer from the JAMS® panel closest to Merritt Island, Florida. To the extent permitted by law, each party shall bear its own costs and fees. Any claim to enforce an arbitration award or for other breach or damages under this Limited Warranty can only be brought in a court of competent jurisdiction closest to Brevard County, Florida.

OTHER EXCLUSIONS -LIMITATION OF DAMAGES - YOUR RIGHTS UNDER STATE LAW.

No employee, other agent of AccuAir or authorized reseller may, amend or waive this written Limited Warranty or make additional representations or warranties regarding any AccuAir features, performance, workmanship or materials. AccuAir reserves the right to make changes in design and changes or improvements upon its products without imposing any obligation on itself to install or upgrade the same upon products previously manufactured.

By installation and use of your AccuAir product, and/or submitting a claim under this **Limited Warranty**, you acknowledge that you have received and understand all product instructions, warnings and this **Limited Warranty** and agree to be bound by all terms therein, reflecting the exclusive terms and remedies of the parties bargain.

*This **Limited Warranty** gives you specific rights. You may also have other rights that vary from state to state. For example, some states do not allow limitations of how long an implied warranty lasts and/or do not allow the exclusion or limitation of incidental or consequential damages, so the limitations and exclusions herein may not apply to you. All other warranties are hereby disclaimed, except to the extent prohibited by applicable law.*



INCLUDED PARTS

DESCRIPTION	BOX #	PART #
JEEP JT WIRING & PLUMBING KIT	1	20-19851
TPAD ASSEMBLY	2	20-18842
JEEP JT ECU ASSEMBLY	3	20-19839
SPEED MODULE	4	20-19833
JEEP JT INFLATION BRACKET ASSEMBLY	5	20-19838
1/4" DOT AIRLINE (75FT)	6	20-20540
JEEP JT COMPRESSOR BRACKET ASSEMBLY	7	20-19837
MOJAVE SPRING & SHOCK COMPONENTS	8	20-20966
JEEP JT AIR SPRING KIT, BOX A	9	20-19834
JEEP JT AIR SPRING KIT, BOX B	10	20-19835
JEEP JT CONTROL ARM KIT ASSEMBLY	11	20-19840
JEEP JT SHOCK KIT	12	20-19836
JEEP INFLATION ACCESSORY KIT	13	20-19830

**FOR A FULL BREAKDOWN OF PARTS INCLUDED IN EACH BOX,
PLEASE REFER TO THE PARTS APPENDIX ON PAGE 77.**

**SAE & SAE Hex Key Sockets/Wrenches**

(5/32", 7/32" & 5/16" Hex Key Sockets, 7/16", 1/2", 9/16", 3/4", 13/16", 7/8" & 1-1/8")

Metric & Metric Hex Key Sockets/Wrenches

(6mm Hex Key Socket, 8mm, 10mm, 13mm, 15mm, 18mm, 19mm, 21mm, 22mm & 24mm)

Allen Wrenches

(4mm, 5mm & 6mm)

Measuring Tape**Safety Glasses****Wheel Chock****Blue Loctite****Jack Stands****Floor Jack****Pliers****Torque Wrench****Wire Brush****Wire Barrel Crimper****Wire Stripper****Heat Gun****T40 Torx Bit****Air Compressor****Rubber-Tipped Air Inflator**



WIRE TERMINATION POINTS

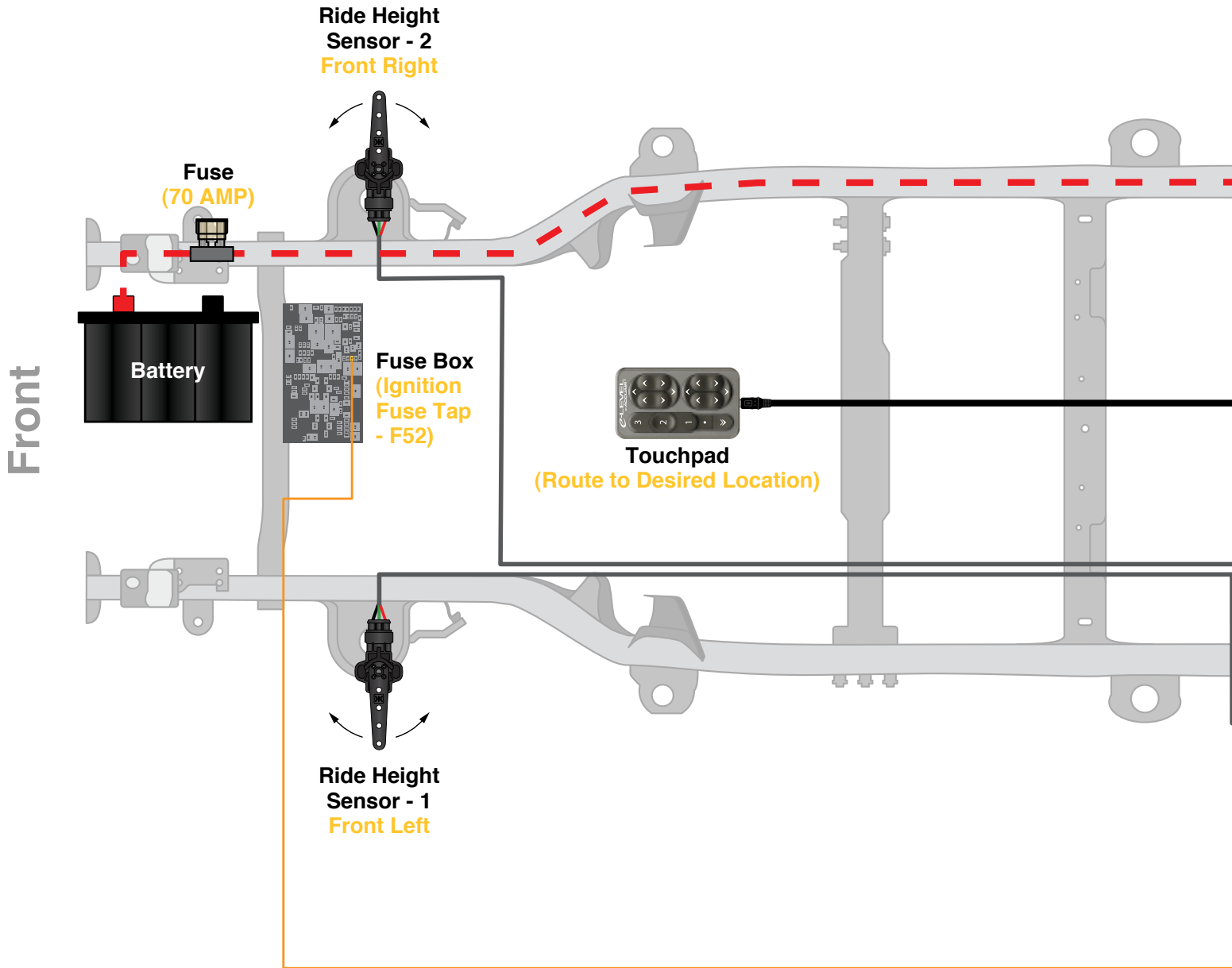

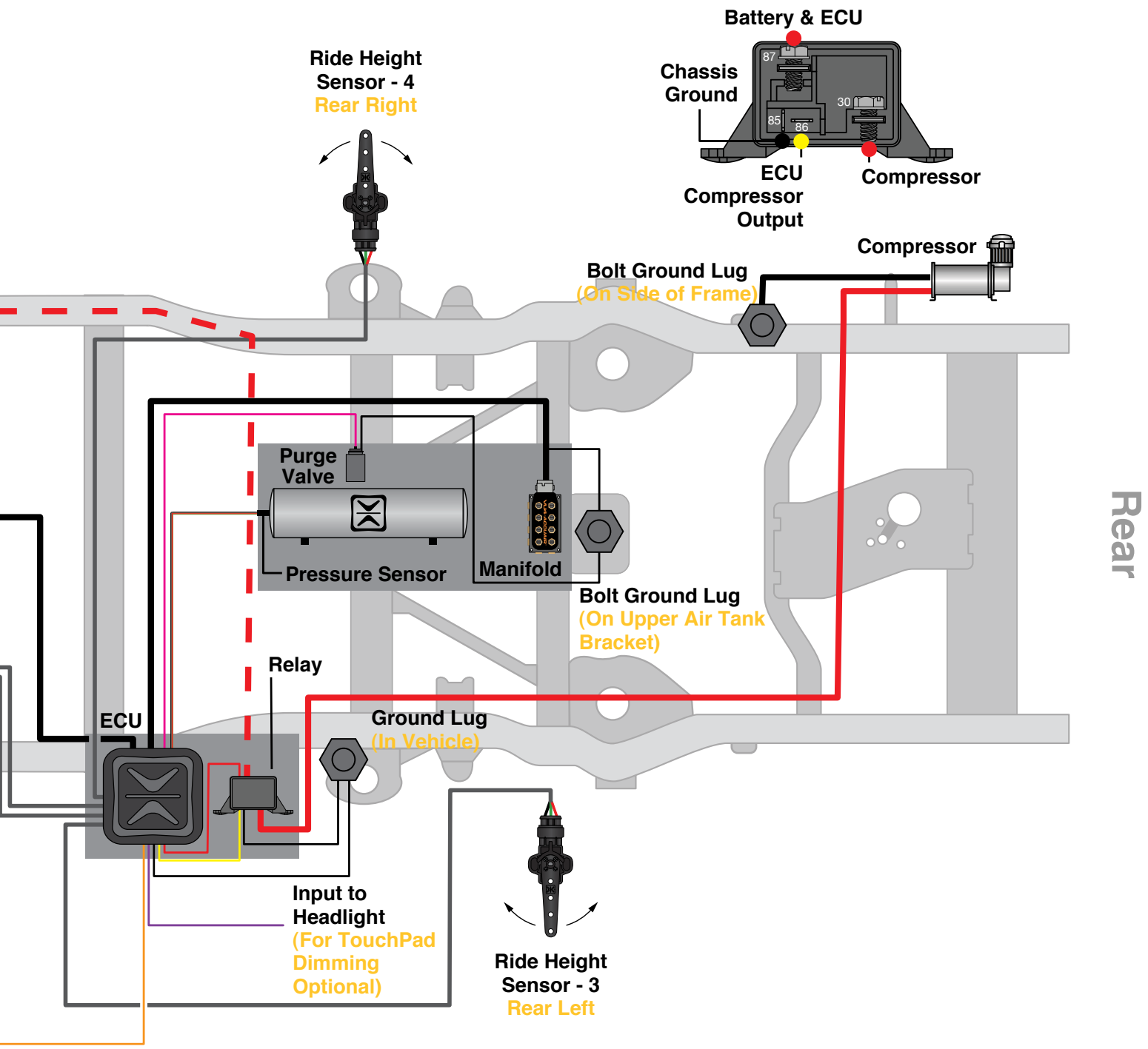

Rear



TAP INTO F52

Front

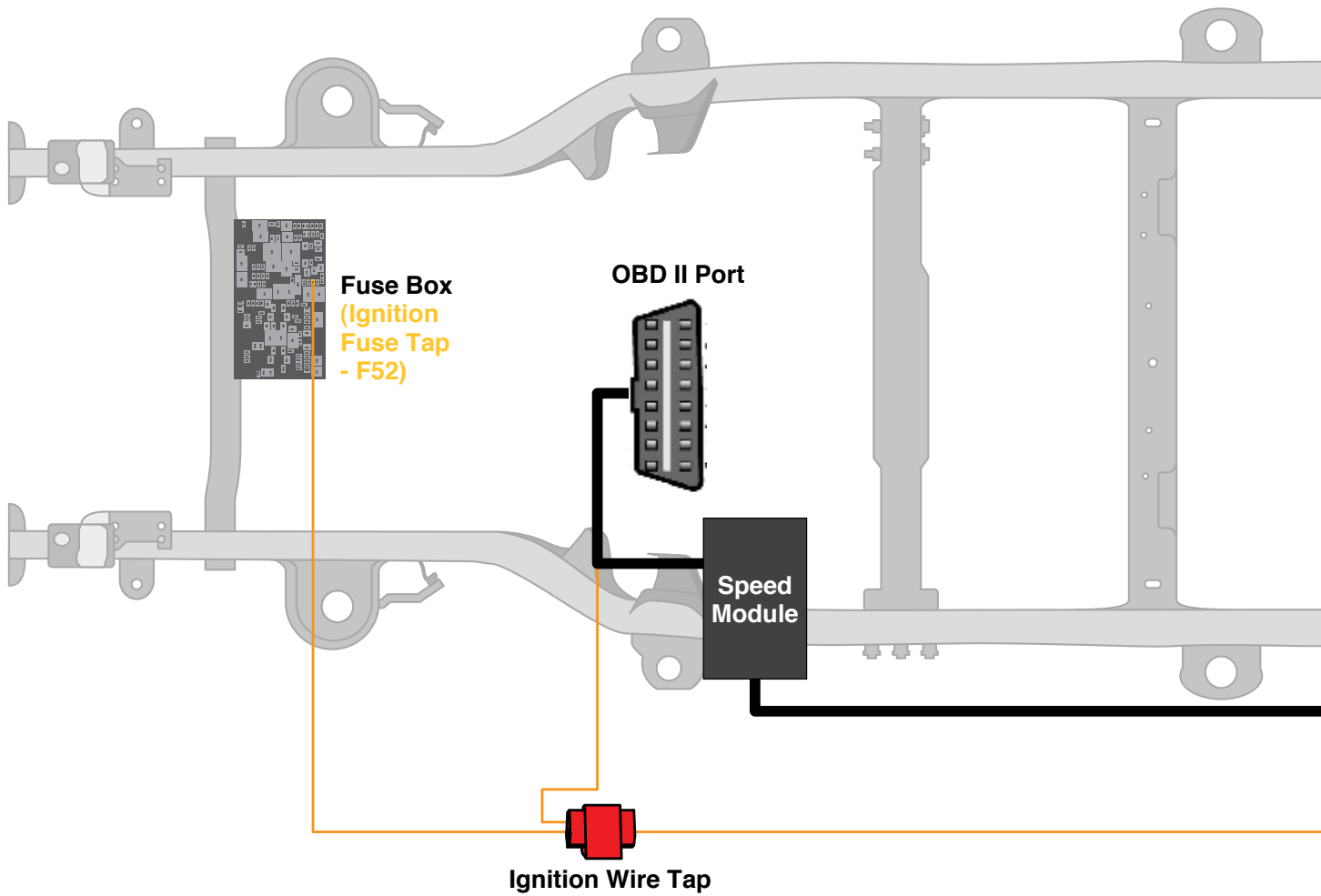

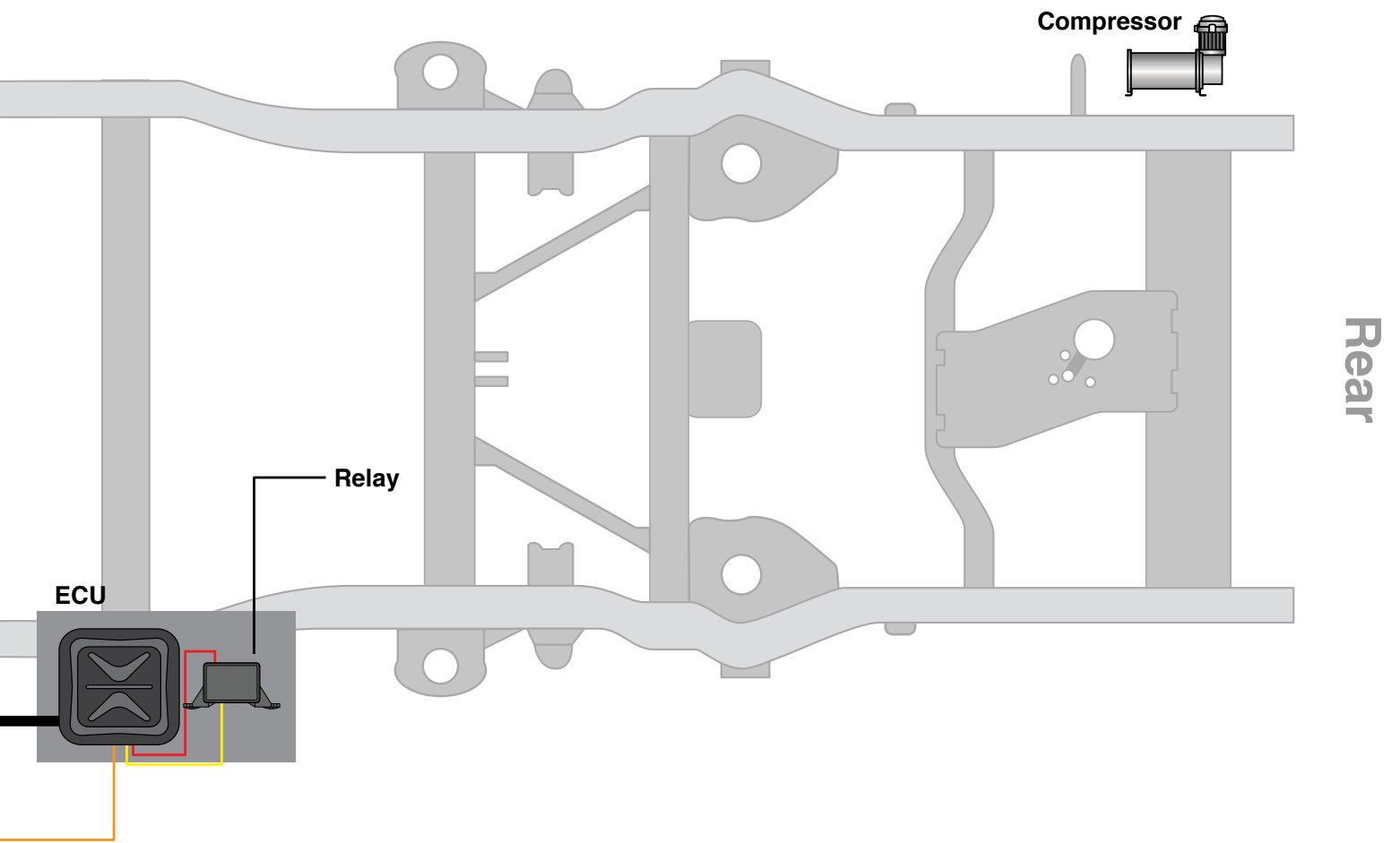



SPEED MODULE ROUTING

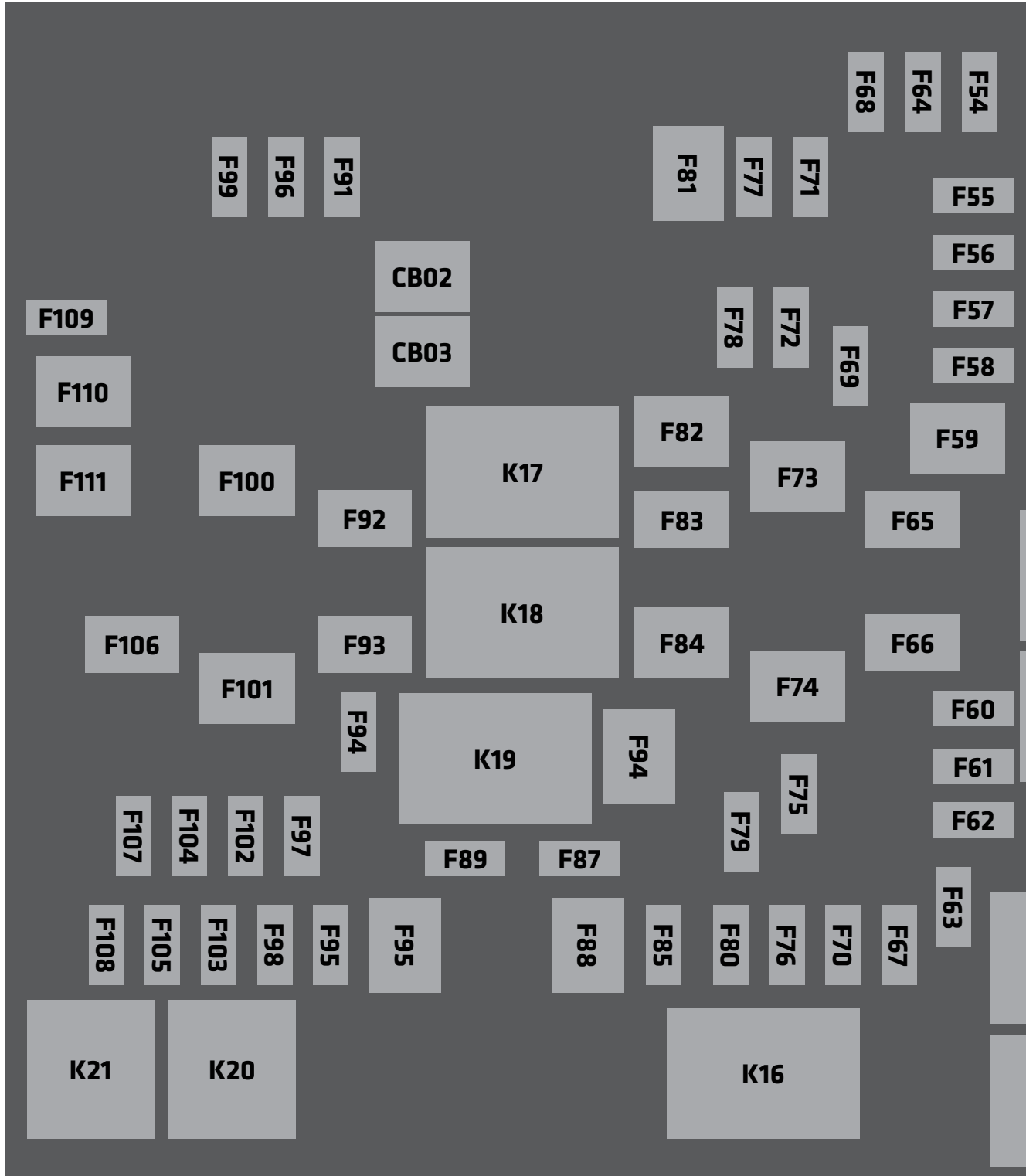





PLUMBING ROUTING

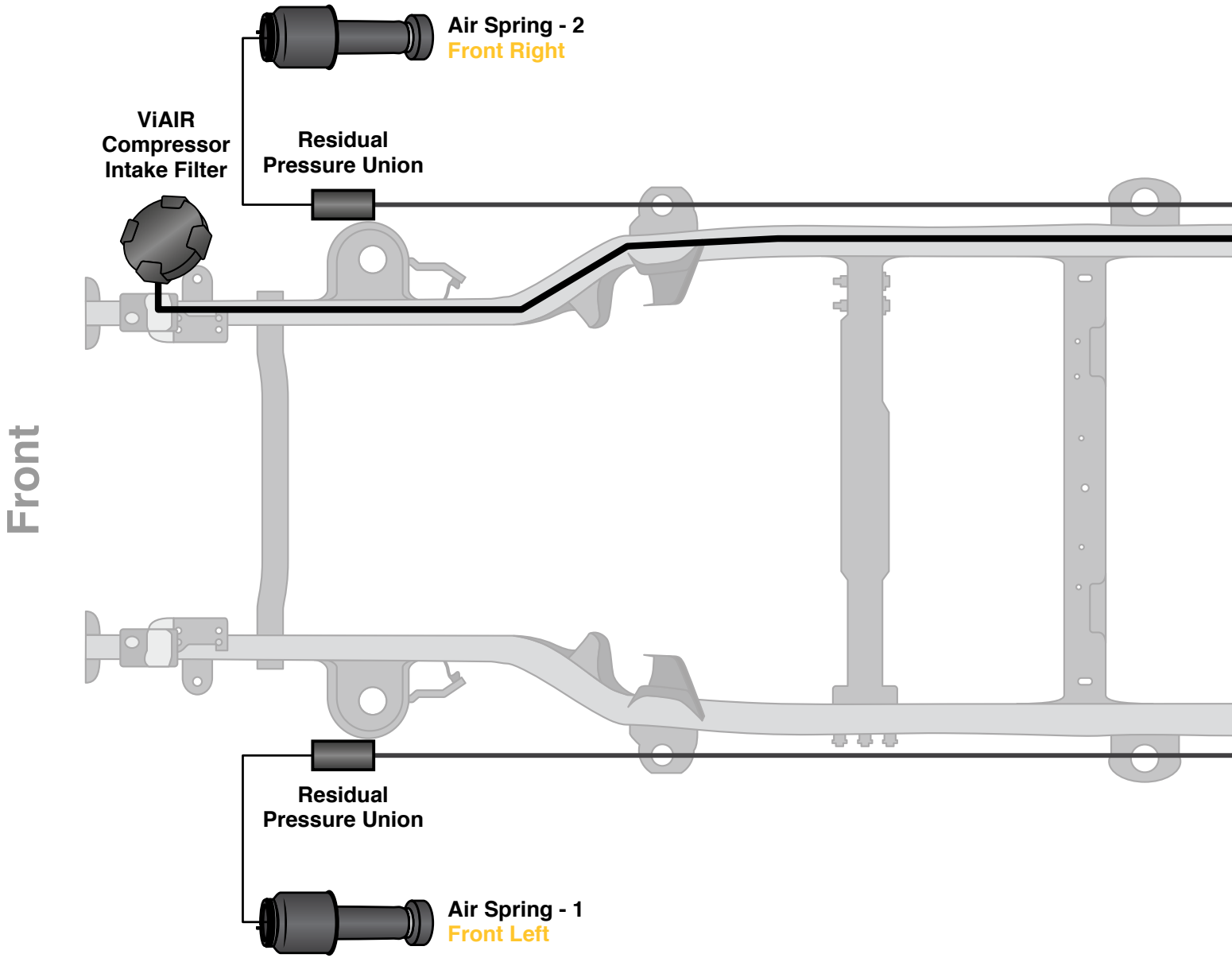

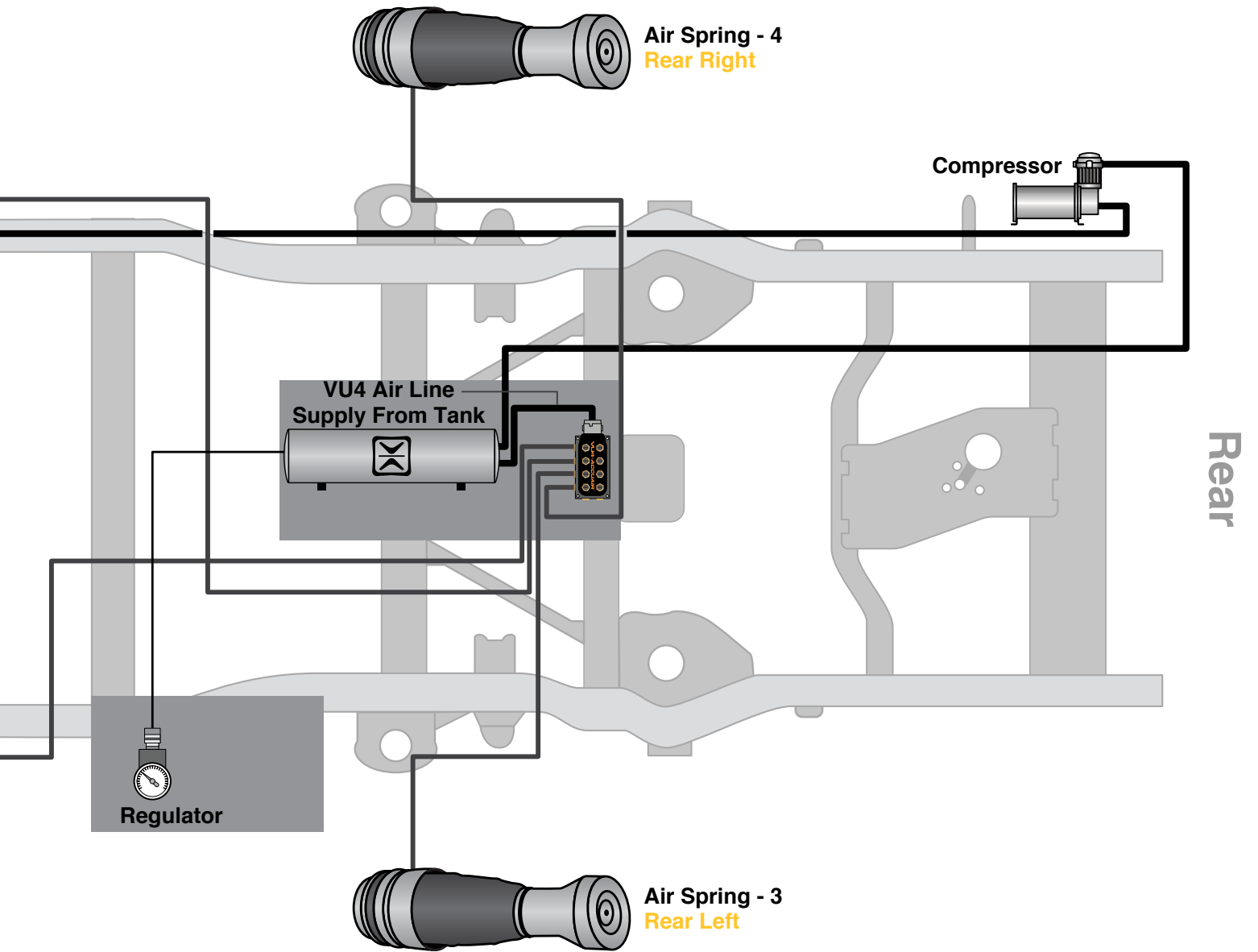



1. Locate the 6 gauge power wire in **Box 1**. (Figure 1)



FIGURE 1

2. Lay the fuse on top of the battery and route remaining wire along the passenger side frame rail to the floor drain plug underneath the center of the vehicle. **Do not connect to battery at this time.** (Figure 2)

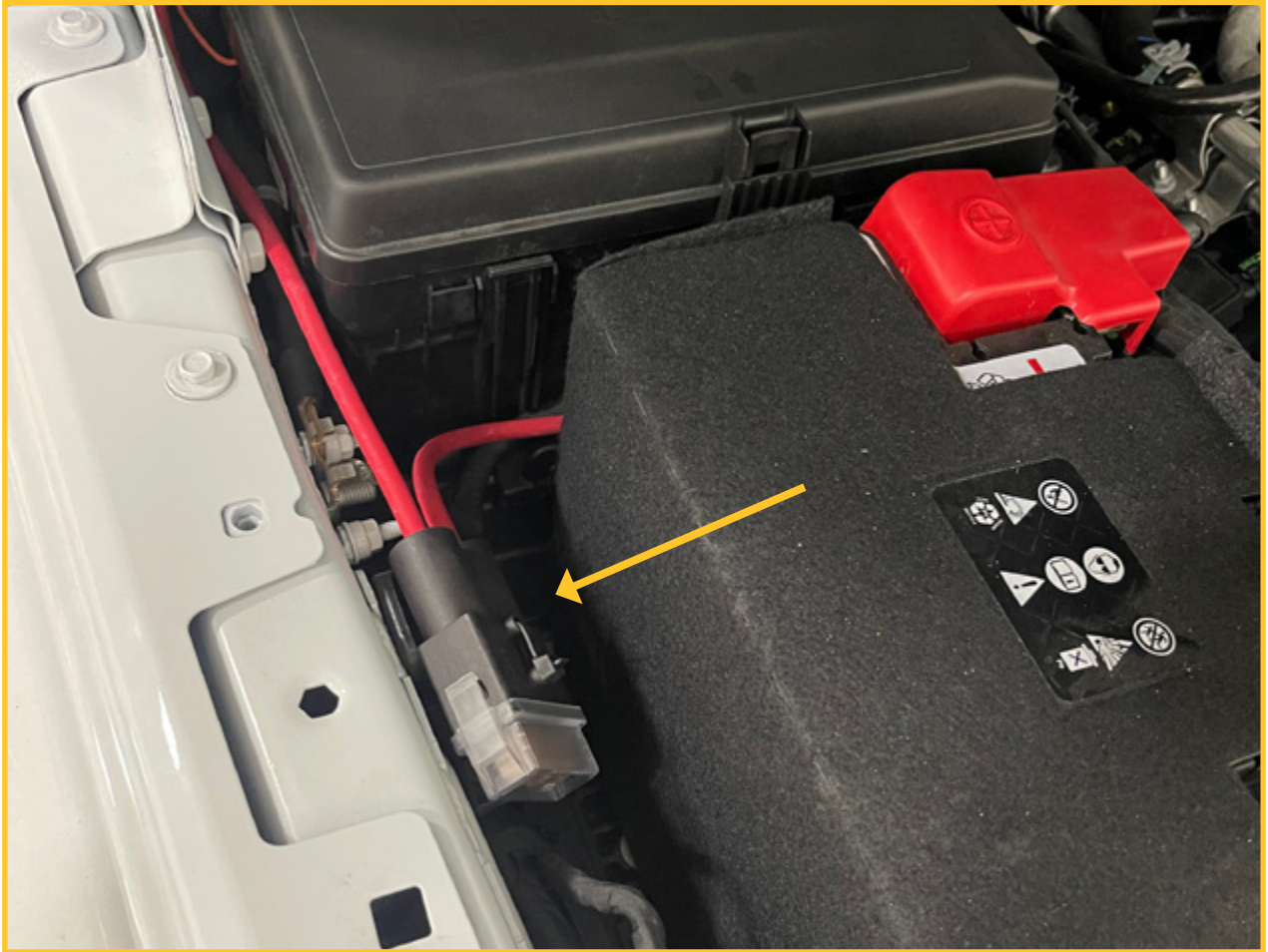

FIGURE 2



WIRING

- Using a T40 torx bit, remove plastic tray from under rear seat. Using a 10mm socket/wrench, remove plastic bolt box under the driver rear seat. Fold carpet forward. (Figures 3, 4)



FIGURE 3



FIGURE 4

- Locate the rubber plug in the floor located above the fuel tank, toward the passenger side, under the rear seat. Remove and install supplied grommet (**Box 1, Bag 20-18283**). (Figures 5, 6)



FIGURE 5



FIGURE 6

5. Pull the ECU main harness plug (**Box 1**), valve harness plug (**Box 1**), compressor power cable (**Box 1**), battery power cable (**Box 1**), and height sensor harness plug (**Box 1**) into the cab via the grommets floor pan hole. Run an end of the 1/4" air line for the pressure regulator into the cab via the grommets floor pan hole. (Figures 7, 8, 9, 10, 11, 12)



FIGURE 7

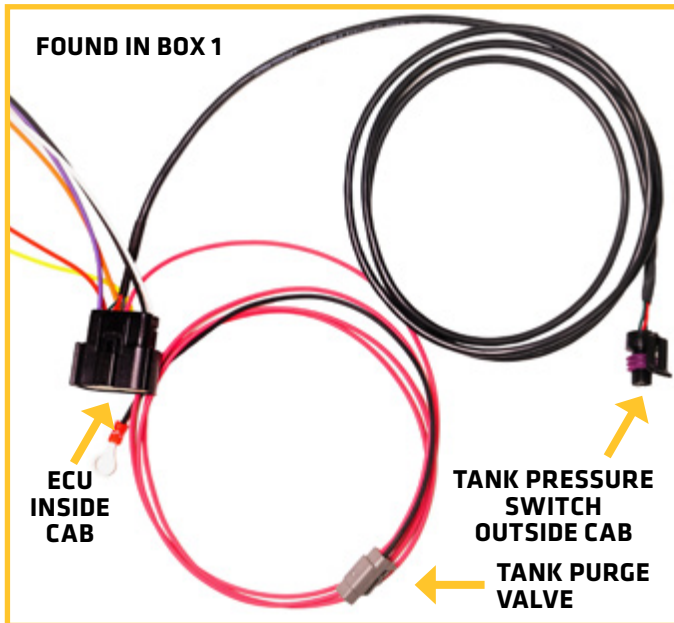

FIGURE 8



FIGURE 9



FIGURE 10



FIGURE 11



FIGURE 12

6. Gather all wire harnesses plus the 1/4" air tubing and bundle them behind the carpet. (Figure 13)
Also add TouchPad cable (white connector - Found in **Box 2**). (Figure 14)



FIGURE 13



FIGURE 14

7. Find the ECU assembly in **Box 3** (Figure 15). Make electrical connections as shown in Figure 16. Refer to relay diagram to make relay connections (Figure 17). Connect 1/4" air line to the pressure regulator.



FIGURE 15

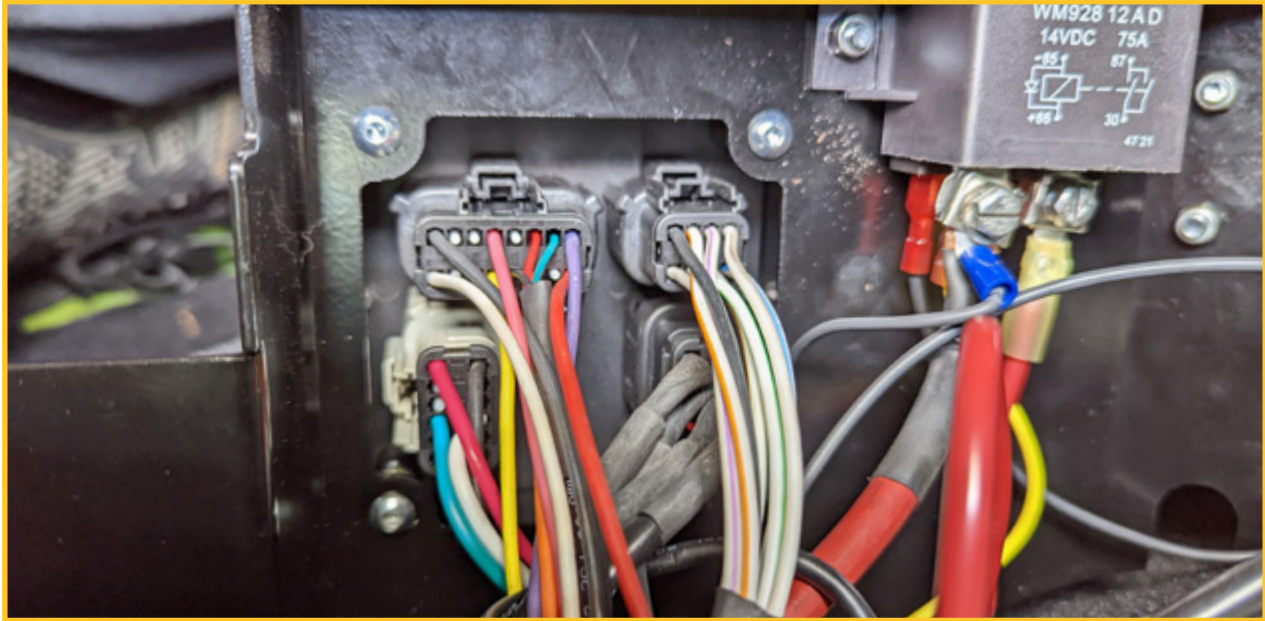

FIGURE 16

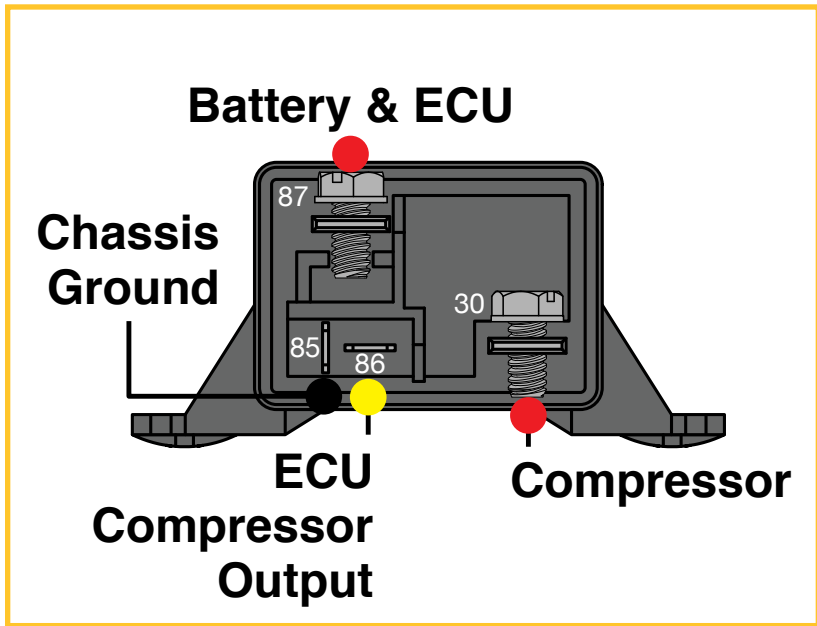

FIGURE 17



8. There will be three grounds, one from the ECU, one from the speed control module and one from the compressor relay. They will go on the stud as pictured. Thread and tighten supplied nut and washer on the stud using a 10mm socket/wrench. (Figure 18)

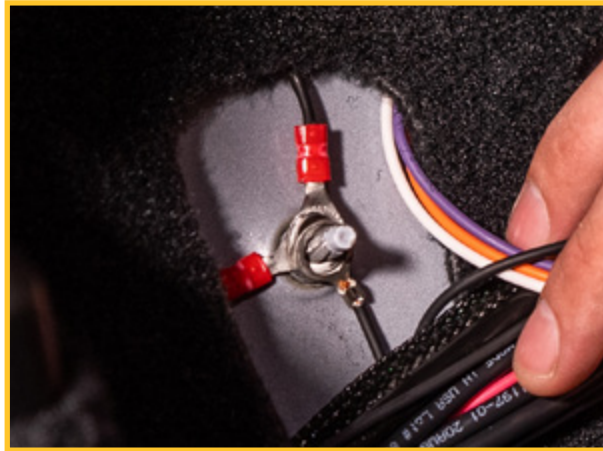

FIGURE 18

9. Run the orange ignition wire from the ECU and the black 2-pin connector under the driver side kick panel toward the driver floorboard. (Figure 19)



FIGURE 19

10. Route the orange ignition wire from the driver side kick panel up to the fuse box under the hood on the passenger side. (Figure 20)



FIGURE 20

11. Crimp the orange ignition wire to the fuse tap provided in **Box 1, Bag 20-18283**. Extract 20 AMP fuse from **F52** and place on bottom position of the fuse tap. Pull the spare **5 (or 10) AMP** fuse and position in top slot of the fuse tap. (Figure 21)

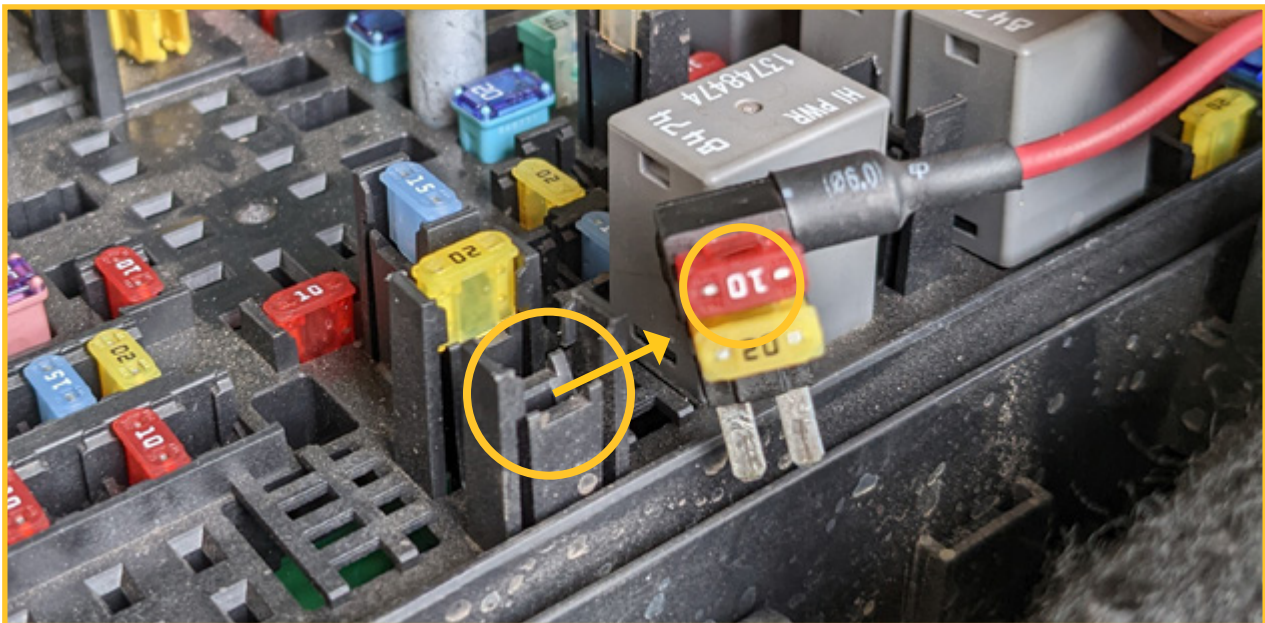

FIGURE 21



12. Remove the fuse in position (**F52**) and install the fuse tap. (Figure 22)

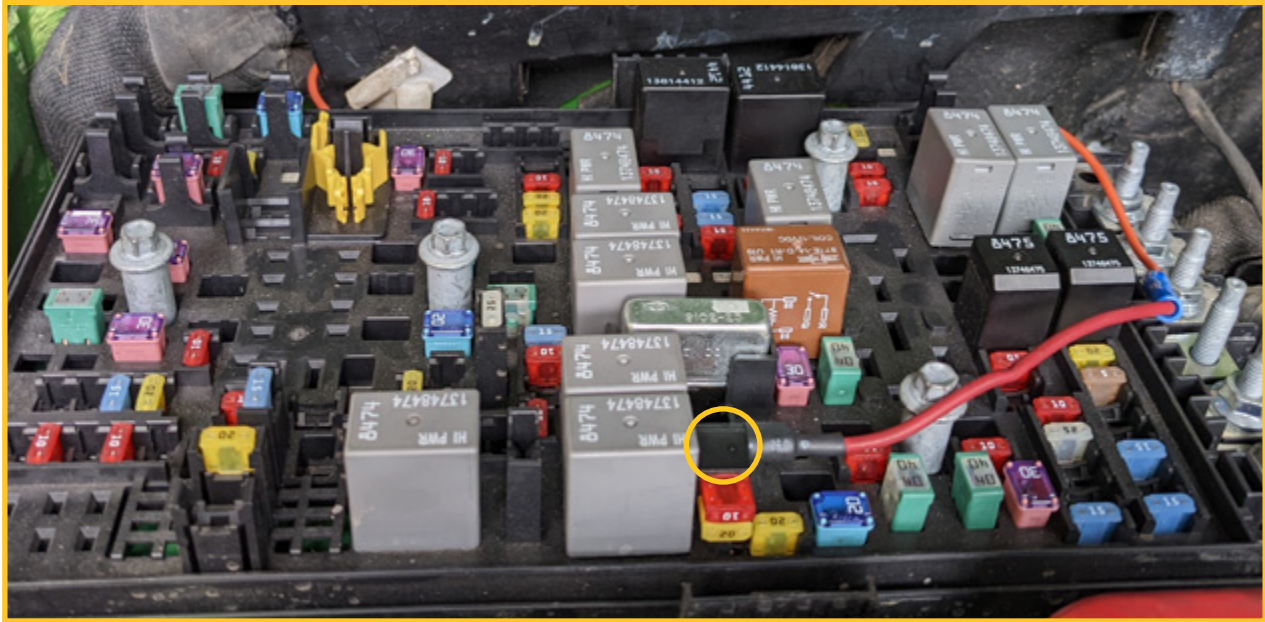

FIGURE 22

13. Install the speed module using hardware from the box labeled **Box 4**.
The supplied speed module must be installed to allow full functionality of the system.
View video using QR code to the right for installation process, or use the following instructions.



SPEED MODULE
VIDEO

14. Connect the HDMI connector to black box and the female OBD2 connector to the male end of the Y-Cable with the flying gray lead. See below. (Figure 23)



FIGURE 23

15. Bring the harness assembly to the driver's side kick panel. Connect the black 12-pin Molex to the black box. (Figure 24)



FIGURE 24



16. Unhook the male OEM CAN bus connector from under the driver's side and connect to the female end of the Y-Cable. (Figures 25, 26)



FIGURE 25



FIGURE 26

17. Take the remaining male CAN bus connector from the Y-Cable and locate it in the OEM CAN bus bracket. (Figures 27, 28)



FIGURE 27

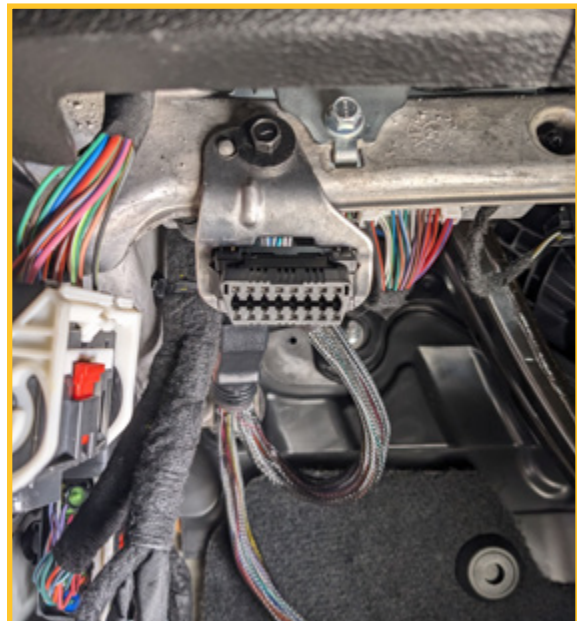

FIGURE 28

18. Locate the T-tap in **Box 1, Bag 20-18283**, install on the orange ignition wire near the driver's side kick panel and connect the gray flying lead wire from the CAN bus Y-Cable. (Figures 29, 30)

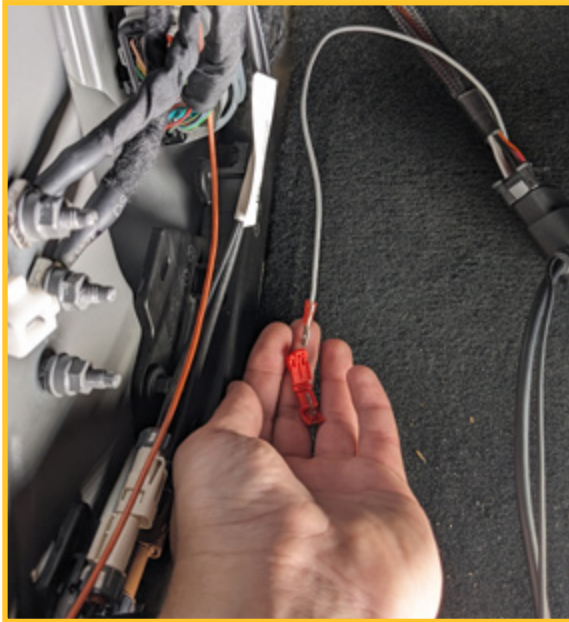

FIGURE 29

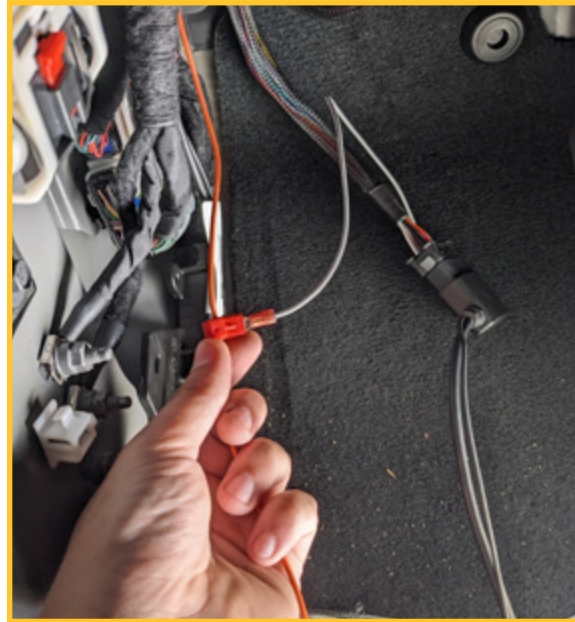

FIGURE 30

19. Route the two-wire cable from the driver's side kick panel through the center console to the passenger side glove box. (Figures 31, 32)

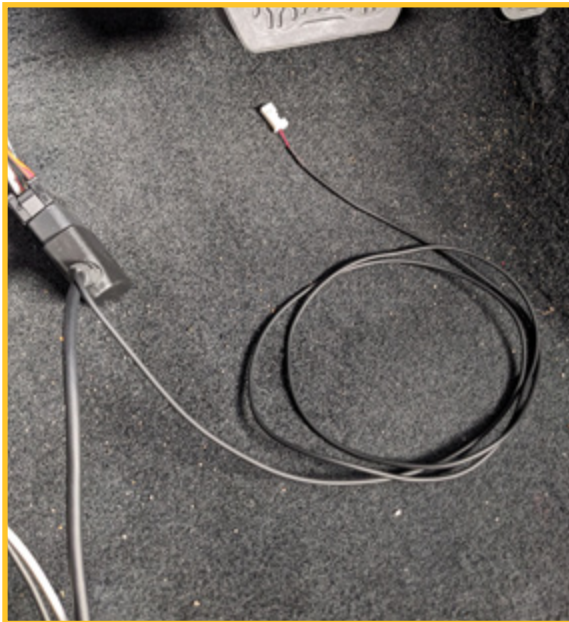

FIGURE 31



FIGURE 32



20. Remove the glove box by pressing on the plastic live latch. (Figures 33, 34)



FIGURE 33



FIGURE 34

21. Take the two-pin wire and connect it into any open position on the green communication bus. (Figures 35, 36)



FIGURE 35



FIGURE 36

22. Locate the air tank bracket and spacer in **Box 5**. Using a 5mm Allen wrench and 13mm socket/wrench, separate the upper and lower brackets and retain the hardware. (Figures 37, 38)
Using a 19mm socket/wrench, remove the spacer (Figure 39) and associated hardware.

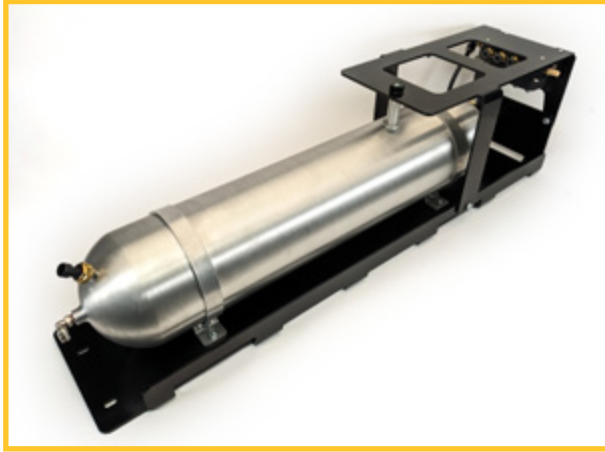

FIGURE 37

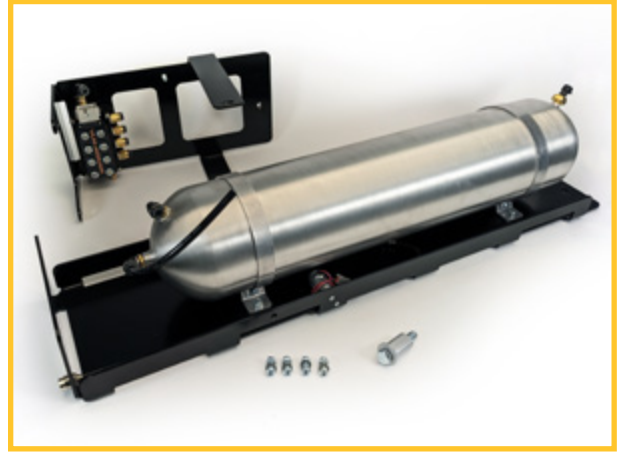

FIGURE 38

23. Install the upper part of the air tank bracket with VU4 manifold attached. This spacer, shown in Figure 39, must be used when installing the bracket to prevent crushing the crossmember when it is fully tightened.



FIGURE 39



Snug bolt using a 19mm socket/wrench. **Do not completely tighten at this time.** You will come back and tighten this bolt after the lower bracket is installed. (Figures 40, 41)



FIGURE 40



FIGURE 41

24. Connect VU4 harness at this time. (Figures 42, 43)



FIGURE 42

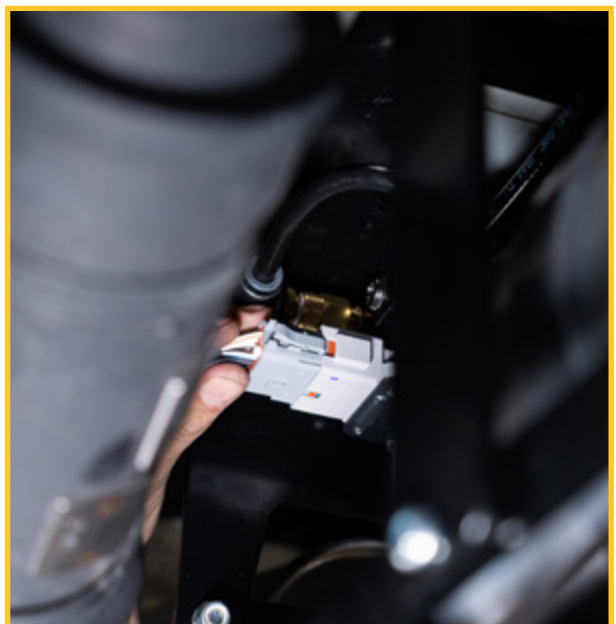

FIGURE 43

25. Run 1/4" tubing (**Box 6**) from the VU4 to all four spring locations. This is also a good time to run the ride height sensor wires to their locations. Run in a safe location away from heat and objects that will pinch or chafe the lines/wires. Ensure the corner-to-port association is correct (Figure 44).

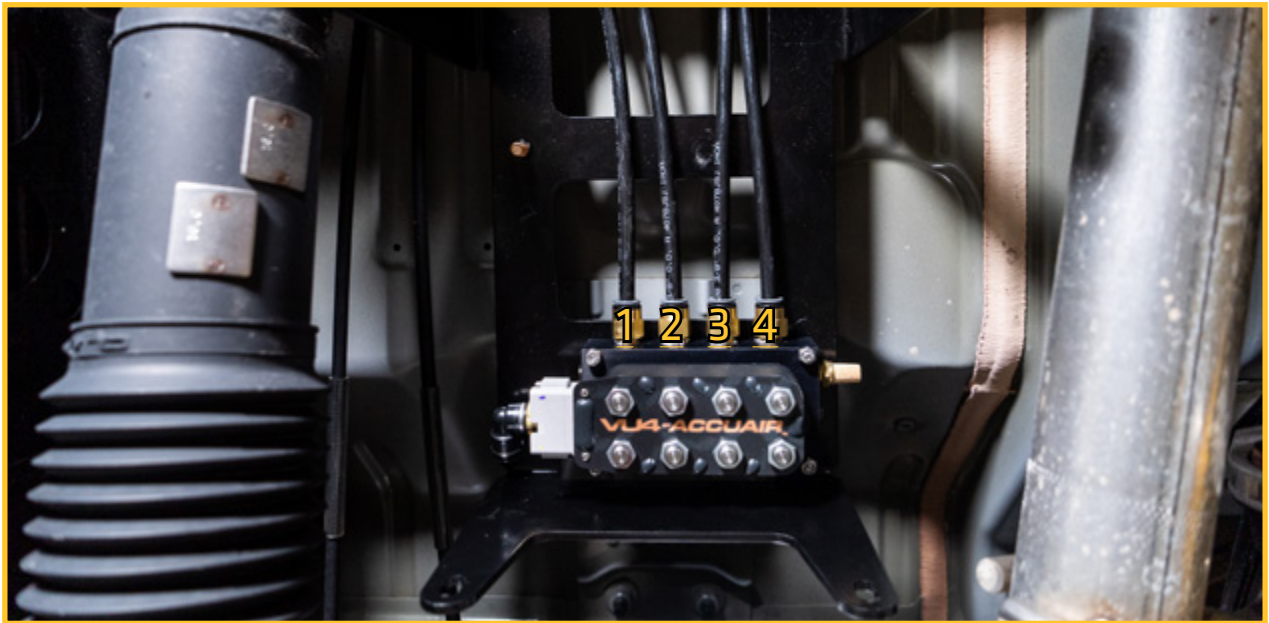
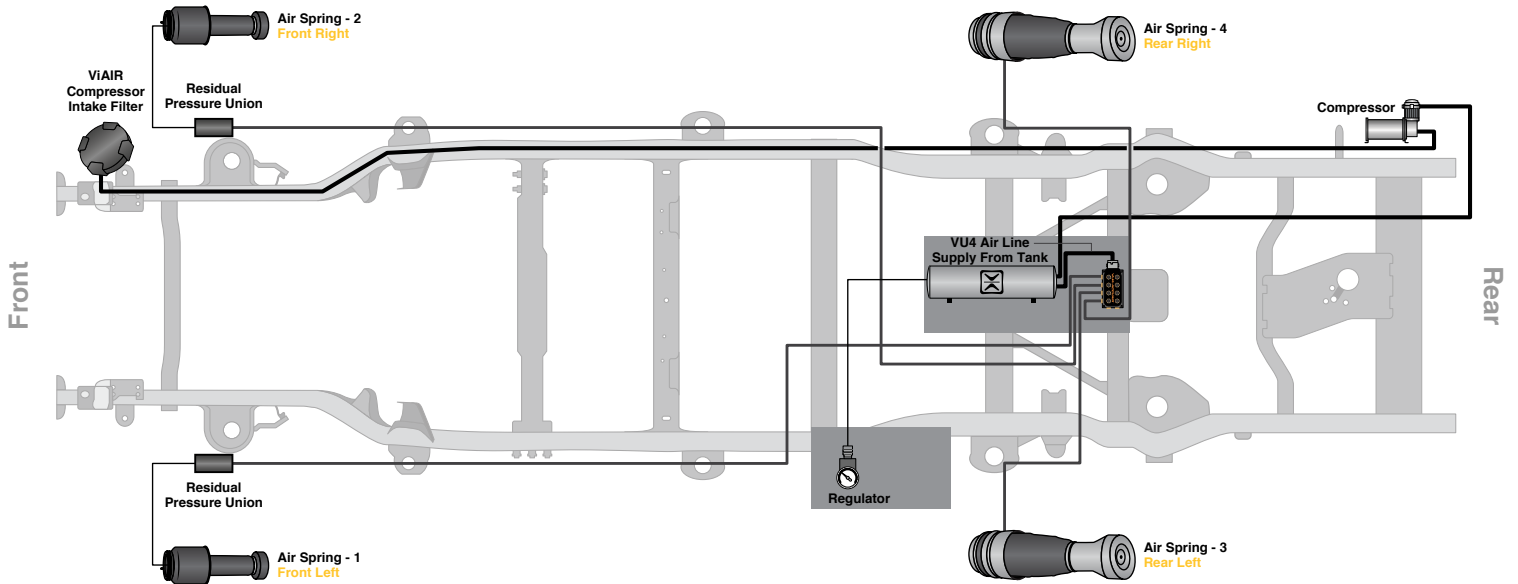

FIGURE 44



26. Locate the compressor bracket and supplied mounting hardware in **Box 7**. (Figure 45)



FIGURE 45

27. Thread supplied 15mm head bolts (**Box 7**) into existing threaded holes on passenger rear of frame. The bracket will slide over these bolts. Install the compressor bracket. Ensure the leader hose from the compressor is routed above the frame. (Figures 46, 47, 48)



FIGURE 46



FIGURE 47



FIGURE 48

28. Ground the compressor to the frame using the factory bolt located in front of the compressor mounting location using a 13mm socket/wrench. (Figures 49, 50)



FIGURE 49



FIGURE 50



29. Install the lower tank bracket to the upper tank bracket using the supplied hardware with a 5mm Allen wrench and 13mm socket/wrench. Two bolts in the front of the brackets utilize factory threaded holes in the transmission cross-member. (Figure 51, 52, 53)



FIGURE 51



FIGURE 52



FIGURE 53

(USE BLUE LOCTITE WHEN INSTALLING THE M8 FASTENERS TO THE FACTORY CROSSMEMBER)

NOTE: Finish tightening the upper tank bracket mounting bolt at this time.

30. Plug in tank pressure sensor located on the front of the air tank. (Figure 54)



FIGURE 54

31. Plug in the tank purge valve. (Figure 55)



FIGURE 55



32. Ground the VU4 harness and purge valve ring terminals to the stud located on the top bracket using supplied washer and Nyloc nut with a 13mm socket/wrench. (Figures 56, 57)



FIGURE 56

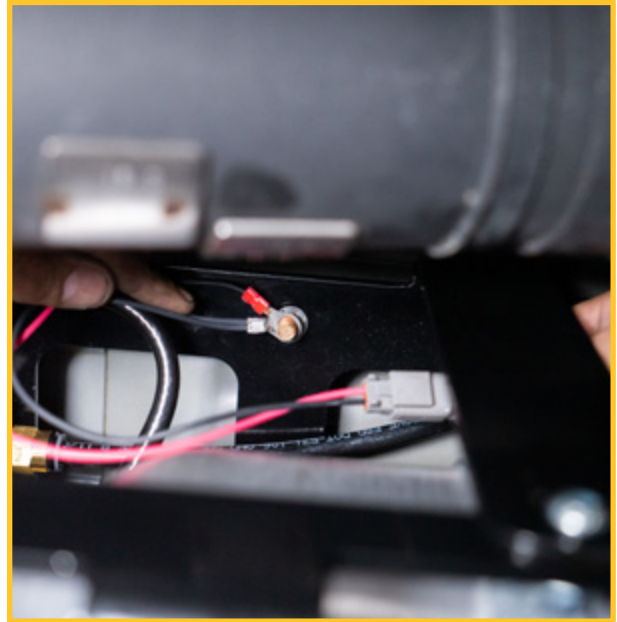

FIGURE 57

33. Run 3/8" tubing (**Box 1**) from VU4 supply to tank. Use provided air line cutter to cut tube to length. (Figures 58, 59)



FIGURE 58



FIGURE 59

34. Run 3/8" tubing (**Box 1**) from push-to-connect on the compressor leader hose to the air tank. (Figures 60, 61)



FIGURE 60

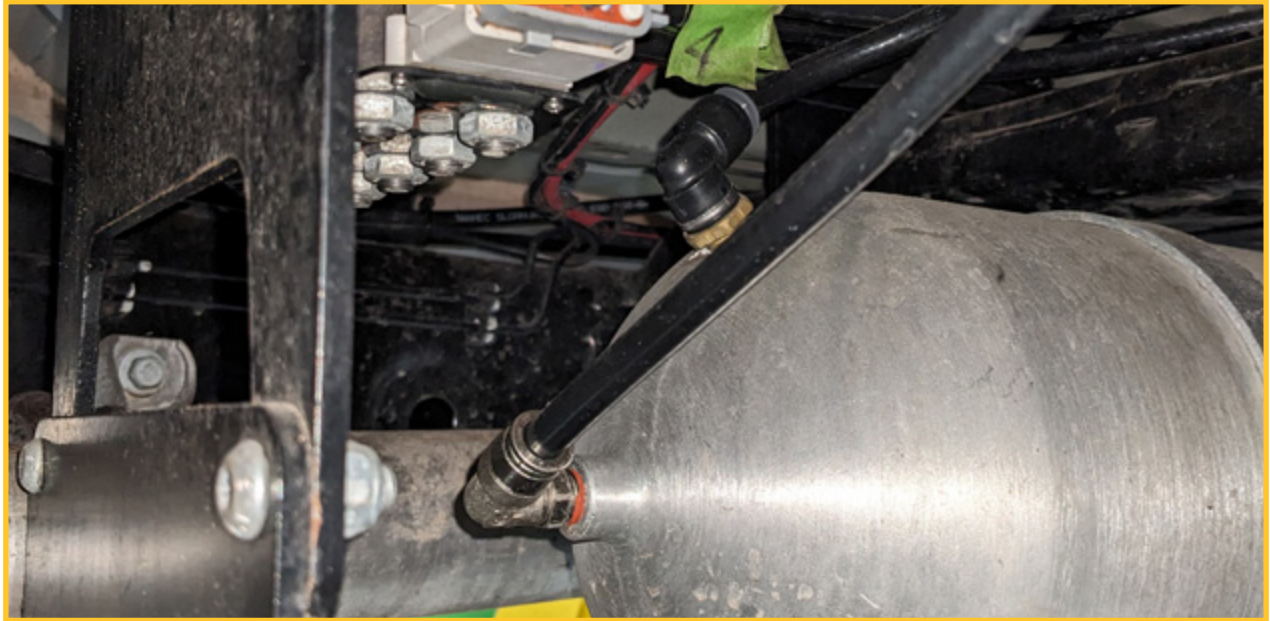

FIGURE 61

35. Run the 3/8" tubing (**Box 1**) from the intake of the compressor to the air box area under the hood and install ViAIR compressor filter (**Box 7**), which has a push-to-connect fitting. (Figure 62)



FIGURE 62

36. Connect 1/4" air line to the front of the air tank. This is the line running through the rubber grommet that connects to the pressure regulator inside the cabin. (Figure 63)



FIGURE 63

37. Ensure 1/4" tubing from the air tank to the push-to-connect fitting on the regulator for the inflation system is secure. (Figure 64)

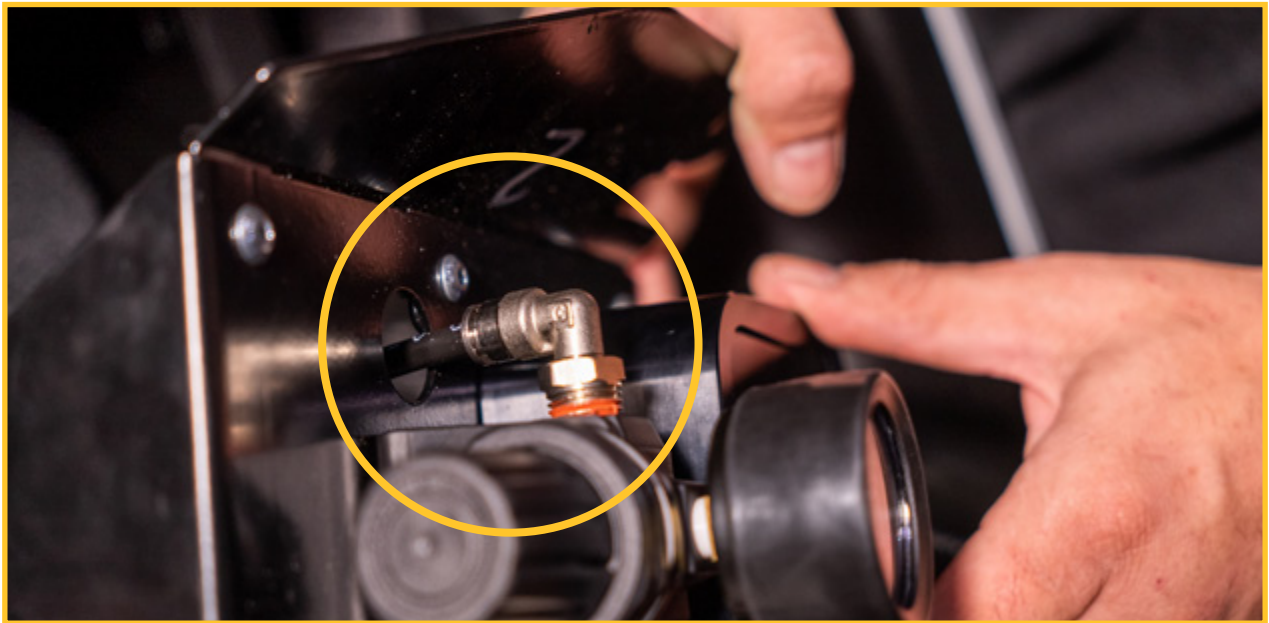

FIGURE 64



38. Replace the plastic tray. The ECU bracket utilizes two of the factory mounting points on the drivers side. (Figures 65, 66)



FIGURE 65



FIGURE 66

39. Replace the bolt storage bin behind the ECU bracket. Make sure both grounds are still in position before tightening with a T40 torx bit and 10mm socket/wrench. (Figures 67, 68)



FIGURE 67



FIGURE 68

40. Hook up the main power by terminating the short leg of the power cable (Ring terminal found in **Box 1, Bag 20-18283**). Remove the 70 amp fuse from the holder. Connect to the battery. Then, reinstall the 70 amp fuse. (Figures 69, 70, 71)

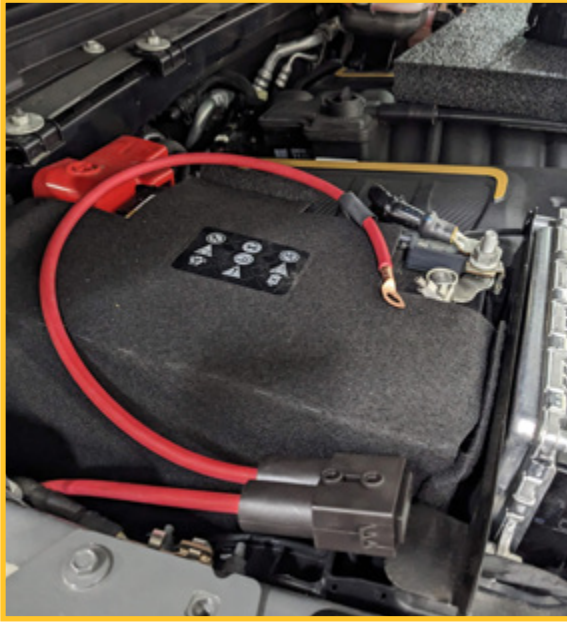

FIGURE 69



FIGURE 70



FIGURE 71



FRONT INSTALLATION

1. With vehicle on flat level ground, set emergency brake & chock rear tires/wheels.
2. Raise front of vehicle. Support frame rails using jack stands at indicated lift points in OEM service manual.
3. Remove the front tires/wheels using a 22mm socket.
4. Remove OEM front sway bar end links using a 6mm hex key socket/wrench & 18mm socket/wrench. (Figure 72)



FIGURE 72

5. Disconnect OEM front track bar from frame using a 21mm socket/wrench. (Figure 73)

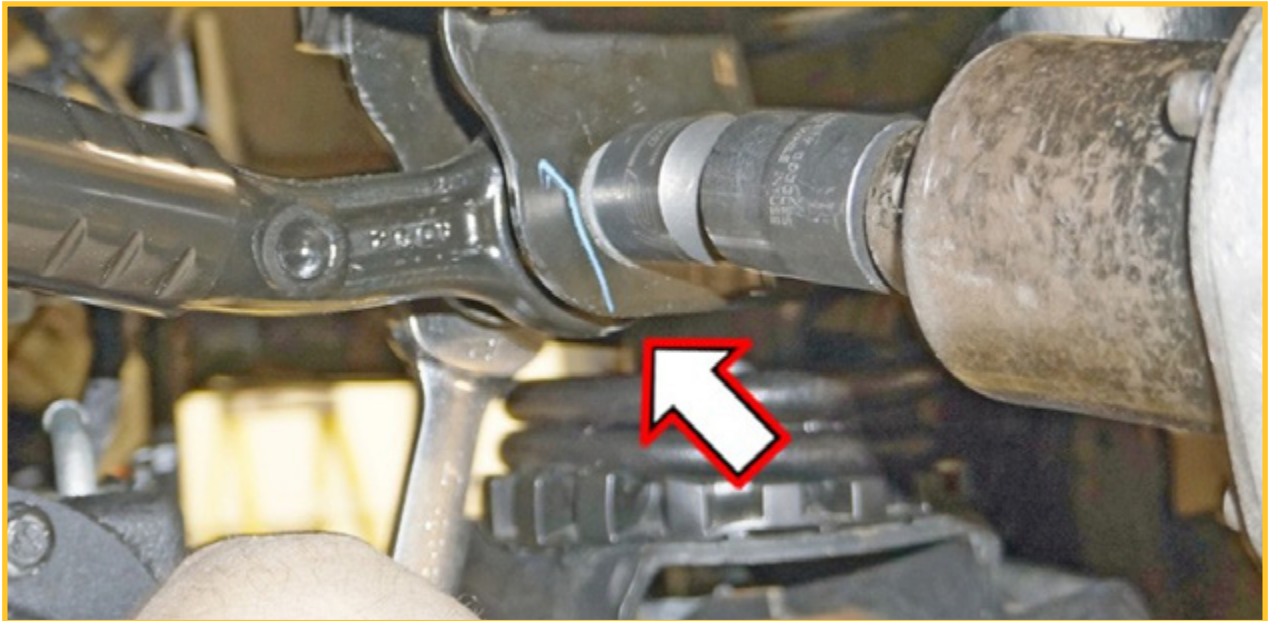

FIGURE 73

6. Disconnect OEM front shock from upper shock tower mount & lower axle mount using a 18mm socket/wrench and retain the hardware. (Figure 74)



FIGURE 74

7. Disconnect OEM front brake line brackets from OEM front lower control arms using a 15mm socket/wrench. (Figure 75)

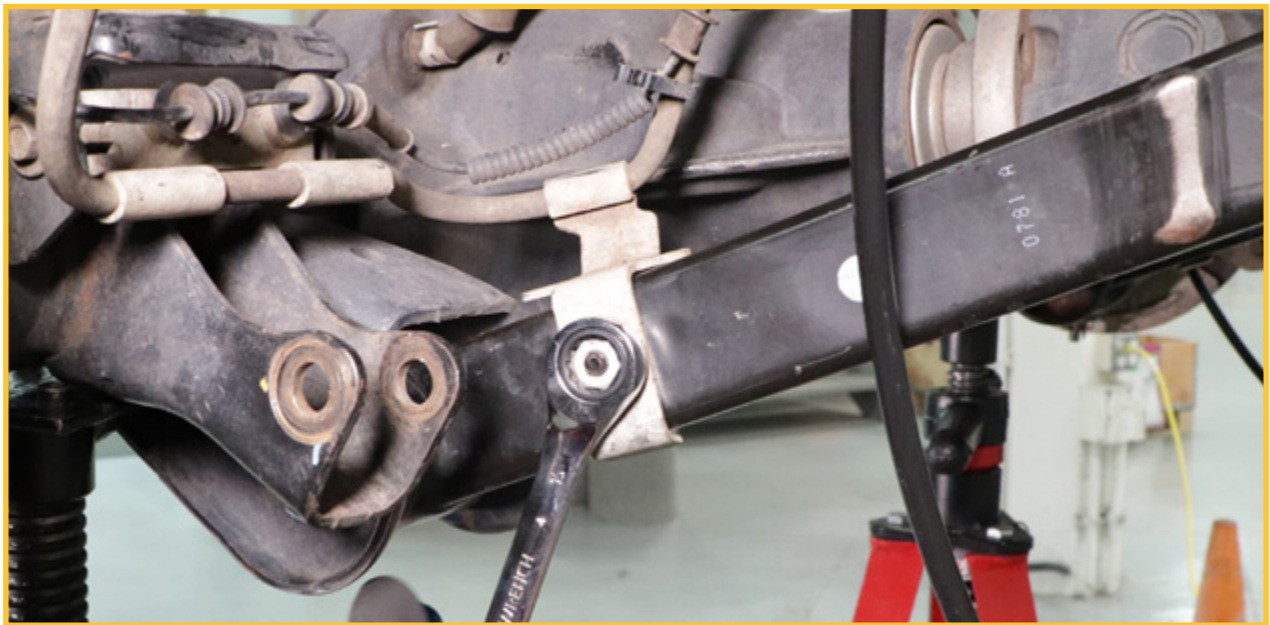

FIGURE 75



FRONT INSTALLATION

8. Disconnect wiring harness from passenger side OEM front upper control arm using pliers.
9. While checking for appropriate slack in ABS lines, brake lines, differential vent hose, etc, lower front differential & remove OEM front coil springs.
10. On both sides, remove the upper and lower spring isolators and the factory hydraulic bump stops from the coil spring bucket, using a 15mm socket/wrench. (Figures 76, 77, 78)



FIGURE 77



FIGURE 76

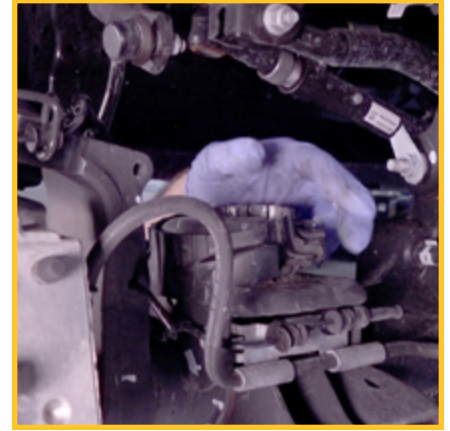

FIGURE 78

11. Locate the air springs in **Boxes 9 & 10, Sub-box 20-15758**. Attach a 48" section of 1/4" air line from **Box 1** to inside of air spring top. The air springs have a push-to-connect fitting. (Figures 79, 80)

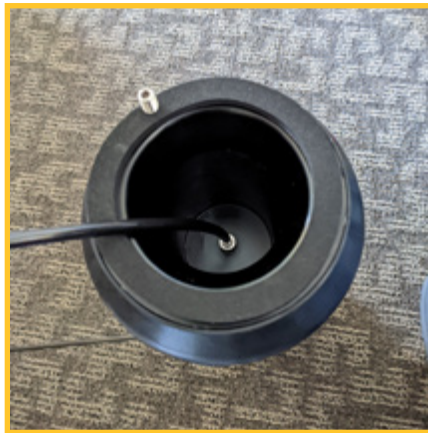

FIGURE 79



FIGURE 80

12. Insert a Mojave Top Mount (**Box 8**) into the top of each air spring, ensuring the air line goes through the top mount. (Figures 81, 82)



FIGURE 81



FIGURE 82

13. Install the new air springs with the air line going through the top mount hole of the frame. (Figure 83)



FIGURE 83



FRONT INSTALLATION

14. Install and tighten the top mounts nuts (**Box 10, Bag 21-17854**) with a 15mm socket/wrench and the bottom mount nuts (**Box 10, Bag 21-17854**) with a 13mm socket/wrench on the air spring. Tighten to 17 ft-lbs. (Figures 84, 85)



FIGURE 84

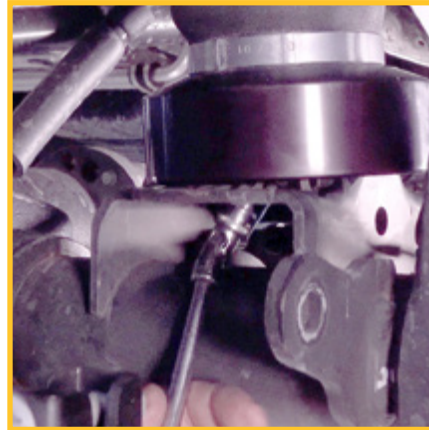

FIGURE 85

15. Install top cap (**Box 10, Bag 21-17854**) with the air line passing through the center. Seat the cap on the top mount. (Figures 86, 86)



FIGURE 86



FIGURE 87

16. One at a time, remove the OEM front lower control arms & install the new front lower control arms (**Box 11**) using the OEM hardware, a 21mm socket/wrench, & 24mm socket/wrench. (Figure 88)

NOTE: Install the new front lower control arms with the offset bend toward the inside of the vehicle.

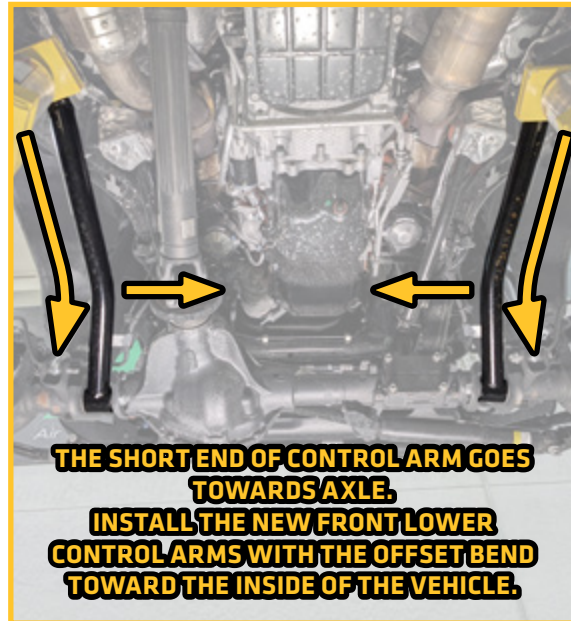

FIGURE 88



WARNING:

Only use the control arms supplied in this kit. Never use alternative control arms.



FRONT INSTALLATION

AIR SPRING PLUMBING

- Using the residual pressure union (**Box 10, Bag 21-17854**), connect the 1/4" air line from the air spring and 1/4" air line from the VU4. (Figure 89)



FIGURE 89



WARNING:

Never lower vehicle to the ground without air springs being fully inflated. Start vehicle and inflate with TouchPad Controller.

18. Inflate front springs using TouchPad Controller. Ignition must be on. Inflate by tapping the double up arrow. (Figure 90)



FIGURE 90

**YOU MUST INFLATE
AIR SPRINGS
BEFORE LOWERING
TO THE GROUND**

Scan the QR code for more details.





FRONT INSTALLATION

FRONT RIDE HEIGHT SENSOR INSTALLATION

19. Install the front ride height sensor bracket assembly (**Box 9, Sub-box 20-17452 & 20-17453**) on the vehicle. The bracket will slide under the heat shield and attach to the frame using the same bolt for the heat shield. The provided nut (**Box 10, Sub-box 21-17908**) will be installed to the back of this heat shield bolt. Tighten to 65 in-lbs. Interlock the upper tab of the sensor bracket into the cutout on the upper control arm mount. (Figures 91, 92)

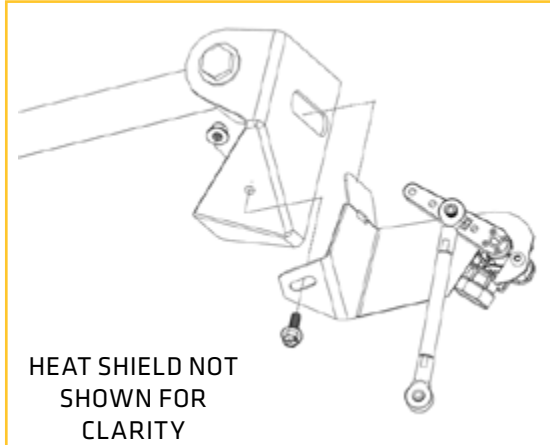

FIGURE 91 - RIGHT FRONT

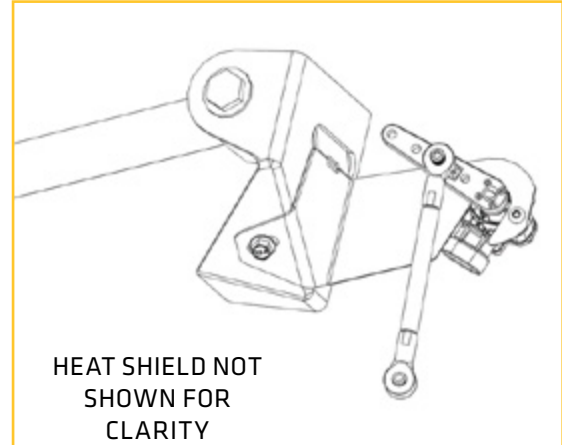

FIGURE 92 - RIGHT FRONT

20. When installed it should look as shown. (Mount link to lower control arm.) (Figure 93)



FIGURE 93



NOTICE:

If lowering vehicle before moving onto rear installation, front air springs **MUST** be inflated. Failure to inflate will cause air spring damage which will not be covered by warranty.

21. Install Front Brake Line Bracket to front lower control arm with OEM hardware using a 15mm socket/wrench. (Figure 94)

Connect OEM front brake line bracket to bracket using supplied 1/4" x 1" Fine Thread Bolt with 1/4" SAE Washer outside & 1/4" SAE Washer with 1/4" Nyloc nut on the inside with a 7/16" socket/wrench.



FIGURE 94



FRONT INSTALLATION

NOTE: Check to see if the factory shock bolts fit through the top and bottom metal bushings. If they **do**, skip Steps 22 - 28. If they **do not**, proceed with Steps 22-28.

22. Locate the four top and two bottom Mojave-specific bushing inserts (**Box 8**) (Figure 95) and JRI front shocks (**Box 12**).



FIGURE 95

23. On one shock, remove the urethane and steel bushings from either side of the top mount. (Figures 96, 97)



FIGURE 96



FIGURE 97

24. If the inserts will not pull out by hand, gently pry the bushings off using a thin-bladed screwdriver or similar. (Figures 98, 99)



FIGURE 98



FIGURE 99



FRONT INSTALLATION

25. You will notice the Mojave-specific inserts are thinner than those just removed. Press them into the bushings. Then, insert the bushings into the top mount. (Figures 100, 101, 102)



FIGURE 100



FIGURE 101



FIGURE 102

26. Flip the shock over, and note the orientation of the bushings, bottom mount, and insert. If the bushing will not pull off of the insert, gently pry the bushing off using a thin-bladed screwdriver or similar. (Figures 103, 104, 105)



FIGURE 103



FIGURE 104



FIGURE 105



FRONT INSTALLATION

27. You will again notice the Mojave-specific insert is thinner than the one just removed. Press it into one bushing, press that into the bottom mount, and then insert the other bushing onto the insert on the other side. Ensure it seats fully into the bottom mount. (Figures 106, 107)



FIGURE 106



FIGURE 107

28. Repeat this procedure for the other shock.

29. Install JRi front shock (**Box 11**) with OEM hardware at upper shock tower mount using a 18mm socket/wrench.

Connect JRi shock at lower axle mount with OEM hardware using a 18mm socket/wrench. Secure, but **do not completely tighten** at this time. To set bushings properly for ride height, these will be tightened once vehicle is on ground with full vehicle weight on tires/wheels.

NOTE:

JRi shocks are monotubes and designed to be mounted with cylinder body up for proper installation of pre-installed upper mount bushings.



WARNING:

Only use JRi Shocks for this vehicle. Use of other shocks can cause air spring failure.

30. Install front tires/wheels using a 22mm socket Lower vehicle to ground. Torque lug nuts to 130 ft-lbs.

31. Make sure that tires/wheels are pointed straight ahead. Install fixed end of Front Adjustable Track Bar (**Box 11**) to frame with OEM hardware using a 21mm socket/wrench. (Figure 108)

NOTE: Do not tighten at this time.

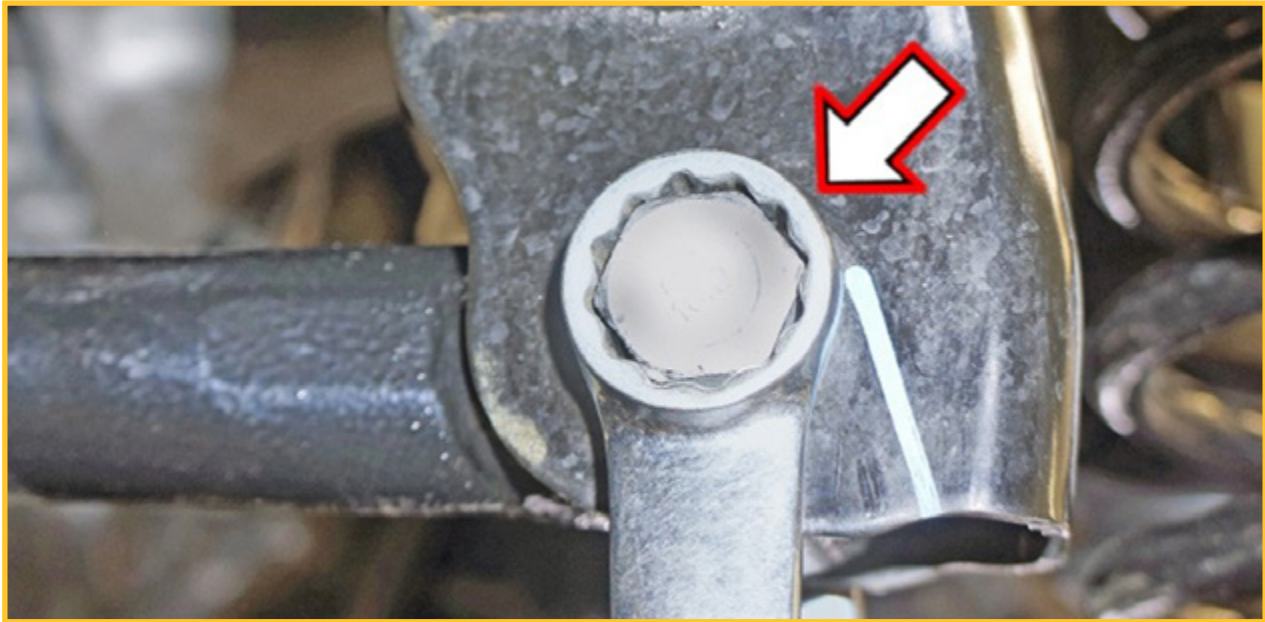

FIGURE 108



FRONT INSTALLATION

32. Install supplied Rod End Bushings (**Box 11, Bag 29-18265**) onto rod end of track bar. Install rod end assembly into front axle mount with OEM hardware using a 21mm socket/wrench. (Figure 109)

NOTE: Do not tighten at this time.

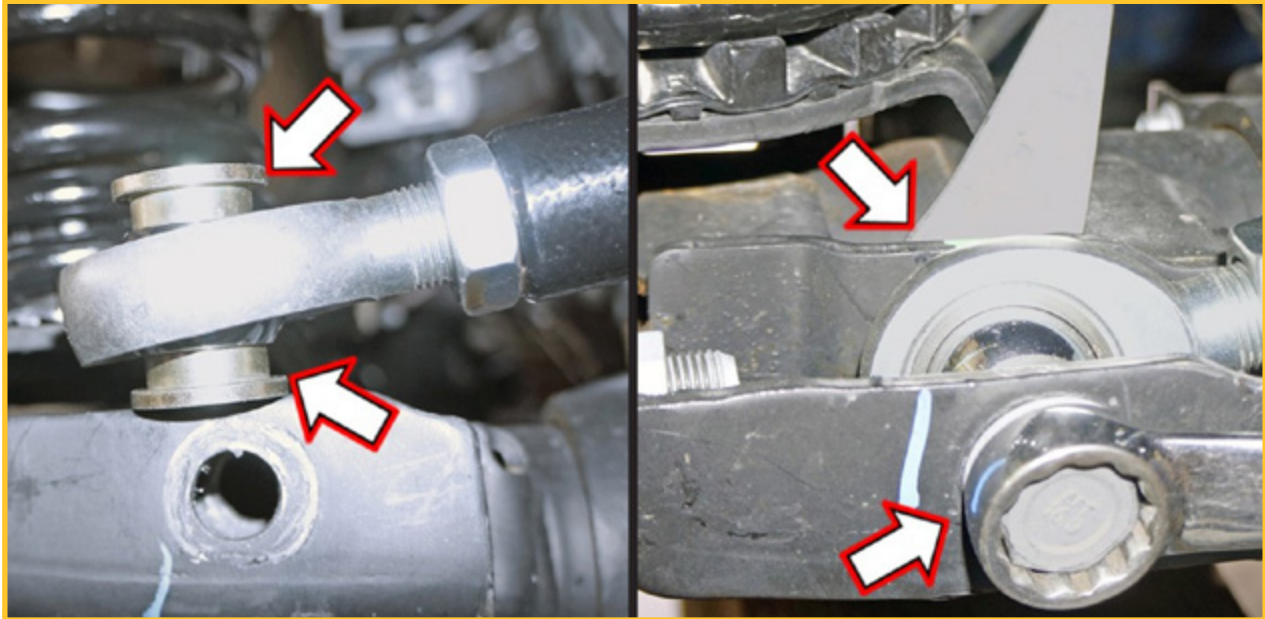

FIGURE 109



WARNING:

Only use supplied track bar. Use of any other may cause instability.

33. Install new front sway bar end links (**Box 11**). (Figure 110)

If 2024+ model year, use supplied sleeves (Box 11) to mount sway bars. (Figure 111)



FIGURE 110



FIGURE 111

NOTE: It may be necessary to turn steering wheel to align track rod end with mount.

Check front of vehicle to make sure body is centered over front tires/wheels. Using a measuring tape, measure from inside of tire to frame on driver side. Then measure passenger side. Compare two measurements; the aim is to make both sides equal.

NOTE: If driver side measurement is greater than passenger side, track bar needs to be lengthened. If passenger side measurement is greater than driver side, track bar needs to be shortened.

Remove adjustable rod end of track bar, loosen jam nut using a 1-1/8" wrench & turn rod end to adjust in or out. Once body is properly aligned over front tires/wheels, tighten OEM hardware using a 21mm socket/wrench. Fully tighten all OEM hardware at upper frame mount & axle mount. Fully tighten jam nut of adjustable front track bar using a 1-1/8" wrench.



REAR INSTALLATION

1. Disconnect both rear sway bar links from chassis and sway bar using an 18mm socket/wrench and a 5mm Allen wrench on the bottom of the end link. (Figures 112, 113)



FIGURE 112



FIGURE 113

2. To gain access to the upper shock bolts, the fender liner can be pulled back to allow a wrench to loosen the shock. (Figure 114)



FIGURE 114

3. Remove factory shocks using a 21mm socket/wrench. This will allow the rear axle to droop enough to remove the factory coil springs. (Figures 115, 116)



FIGURE 115

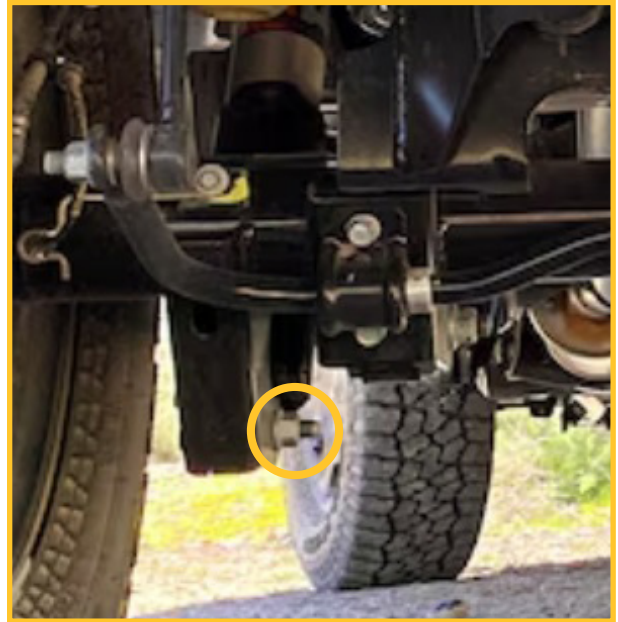

FIGURE 116

4. Lower the rear axle and remove the rear coil springs and rubber spring isolators. (Figures 117, 118)



FIGURE 117



FIGURE 118



REAR INSTALLATION

5. Install the new JRi Shocks (**Box 12**) using OEM hardware with a 21mm socket/wrench. (Figures 119, 120)



FIGURE 119



FIGURE 120

6. One at a time, remove and replace the rear arms, starting with the upper arms first using a 21mm socket/wrench. (Figures 121, 122, 123, 124, 125, 126, 127, 128)
All replacement arms can be found in **Box 11**.



FIGURE 121



FIGURE 122



FIGURE 123



FIGURE 124



FIGURE 125



FIGURE 126



REAR INSTALLATION



FIGURE 127



FIGURE 128

7. Find rear height sensors located in **Box 9**. On the upper arms, you will need to install the height sensor bracket while installing the upper link bar bolt on the frame using a 21mm socket/wrench. Ensure the locating tabs on the height sensor bracket are sitting against the mount. When installing the upper link bar, the welded tab for height sensor linkage should be on top and towards the frame. (Figure 129)



FIGURE 129

8. After you finish installing all four rear arms, connect the rear height sensor linkage to the upper arm using the supplied hardware and spacer. (Figures 130, 131)



FIGURE 130



FIGURE 131

9. Locate air spring straps (**Box 10, Air Spring Box B, Bag 21-17854**) (Figure 132)
Using a 13mm socket/wrench, attach end with 90° angle to the bottom of each air spring. (Figures 133, 134)



FIGURE 132



REAR INSTALLATION



FIGURE 133



FIGURE 134

10. Install new rear air springs by inserting the locating tab inside the hole on the lower perch and rotating the bag to the rear of the vehicle. Ensure locating tabs are on the outside of this bracket (towards center of the axle). (Figures 135, 136)



FIGURE 135



FIGURE 136

11. Connect the 1/4" air line from appropriate valve location to the top of the air spring. Then push the top of the air spring into the factory spring pocket and install the retaining clip (**Box 2, Air Spring Box B, Sub-box 21-17854**) as pictured. (Figures 137, 138, 139)



FIGURE 137



FIGURE 138



FIGURE 139



REAR INSTALLATION

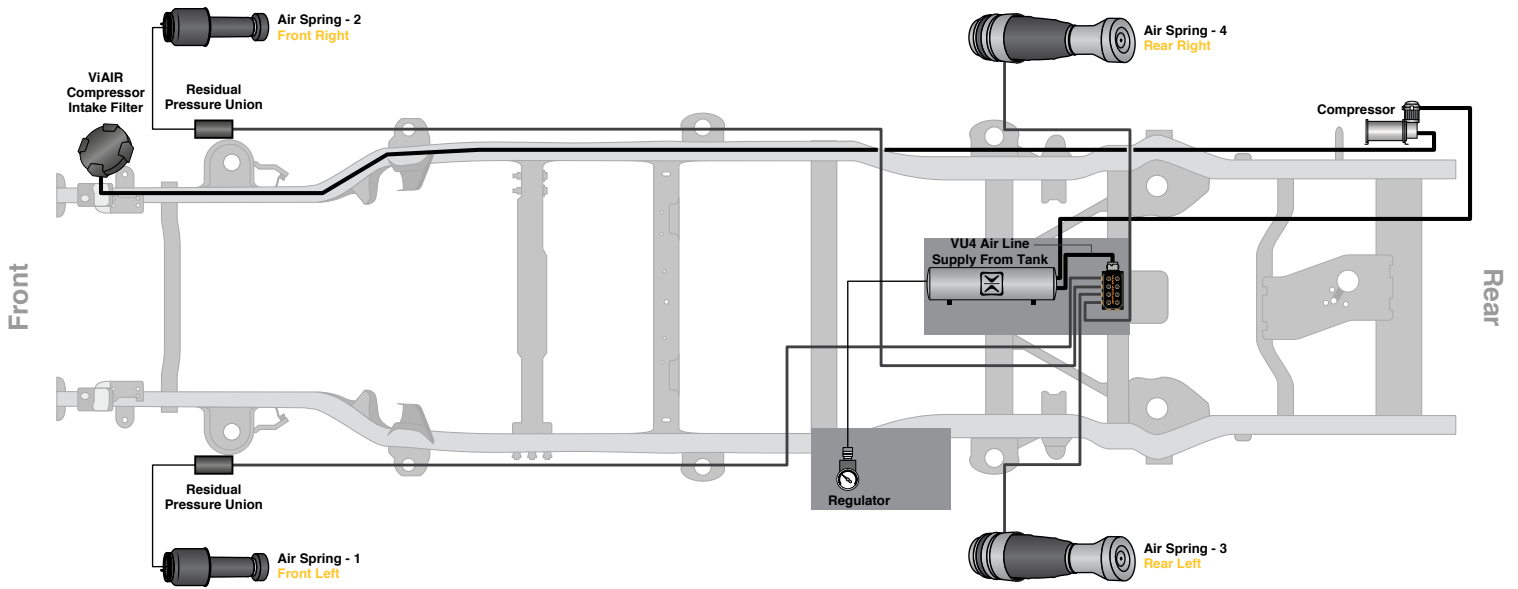

12. Install new rear sway bar end links found in **Box 11**, reusing the OEM hardware. (Figure 139)



FIGURE 140

13. Install the track bar relocation bracket to the rear axle using the supplied hardware (**Box 11**) and spacers through the factory mounting hole using a 21mm socket/wrench and a 17mm socket/wrench. (Figures 141, 142)



FIGURE 141



FIGURE 142

14. Ensure the flange pictured is sitting flush to the factory bracket. Drill two 12mm (21/64") holes and install bolts. At this time, you can reinstall the track bar to the new mounting location, using OEM hardware and a 21mm socket/wrench. (Figures 143, 144)

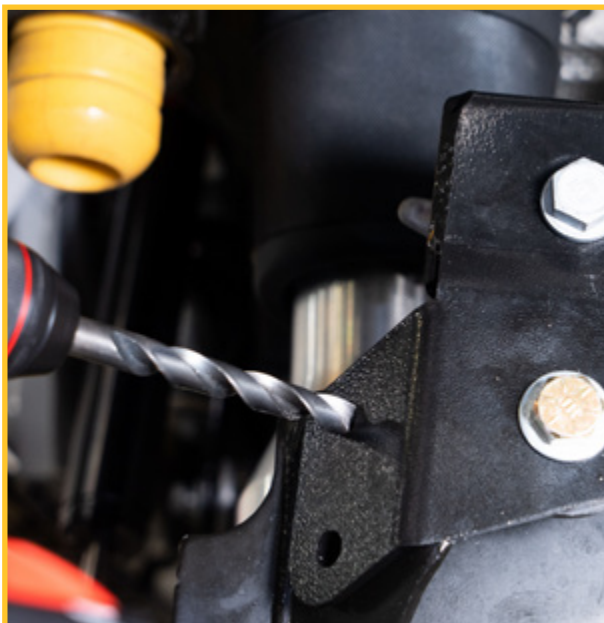

FIGURE 143



FIGURE 144



REAR INSTALLATION

15. Install the rear bump stop extensions (**Box 9**) using supplied hardware with a 13mm wrench. (Figures 145, 146)



FIGURE 145



FIGURE 146



WARNING:

Never lower vehicle to the ground without air springs being fully inflated. Start vehicle and inflate with TouchPad Controller.

16. Inflate rear springs using TouchPad Controller. Ignition must be on. Inflate by tapping the double up arrow. (Figure 147)



FIGURE 147

**YOU MUST INFLATE
AIR SPRINGS
BEFORE LOWERING
TO THE GROUND**

Scan the QR code for more details.



17. Install rear tires/wheels using a 22mm socket.

18. Lower vehicle to ground. Torque lug nuts to 130 ft-lbs.

**AFTER INSTALLATION,
VEHICLE MUST BE PROFESSIONALLY ALIGNED BY ALIGNMENT CENTER.**



FINAL CLEARANCE CHECK & TORQUE STEPS



CALIBRATION VIDEO

CALIBRATION MUST BE PERFORMED

Once system installation is complete, the system will need to be calibrated. Calibration is a process that will learn the vehicle range of travel and automatically set ride heights.

The vehicle needs to be on level ground with the wheels pointed straight ahead. Leave the vehicle running to power the compressor(s) during this procedure.

Before starting calibration, turn on the vehicle and let the compressors run to fill the tank. Once the compressor stops running (green “C” on TouchPad stops blinking) you may simultaneously hold the “dot” and “1” button for 5 seconds. You may let go when the vehicle starts to move up.

The vehicle will now open the valves to the air springs and run the compressor to fill all air springs. The system will continue doing this until the set pressure is achieved at which point the maximum suspension travel will be defined.

Next, the vehicle will exhaust all air from the air springs to define the minimum travel.

Calibration is complete when the system prompts a position 2 two adjustment (“2” will be flashing on the TouchPad). This may take some time as the system has to fill the tank and air springs from near empty.

1. Start vehicle. Make sure there are no dash lights pertaining to suspension.
2. Bounce the vehicle a few times. This will help suspension settle to new ride height. Cycle steering lock-to-lock & check all components for proper operation & clearances. Pay special attention to clearance between tires/wheels, Shocks, control arms, brake hoses, ABS wiring, etc.
3. Front Tighten & Torque Sequence.
 - Track bar at frame using a 21mm wrench. Torque to 52 ft-lbs.
 - Track bar at axle using a 21mm wrench. Torque to 52 ft-lbs.
 - Front shock absorber upper mount using a 18mm wrench. Torque to 81 ft-lbs. Front shock absorber lower mount using a 18mm wrench. Torque to 74 ft-lbs.
 - Sway bar end link upper bolt using a 19mm socket/wrench. Torque to 59 ft-lbs.
 - Sway bar end link lower bolt using a 18mm socket/wrench. Torque to 59 ft-lbs.
4. Rear Tighten & Torque Sequence.
 - Track bar bracket bolts. 1/2” Bolts Torque to 90 ft-lbs. 9/16” Bolt Torque to 130 ft-lbs.
 - Track bar at the bracket. Torque to 130 ft-lbs.
 - Rear shock absorber upper mount using a 18mm socket/wrench. Torque to 81 ft-lbs. Rear shock absorber lower mount using a 18mm socket/wrench. Torque to 74 ft-lbs.
 - ADX Reservoir clamp. Double check position & clearance. Tighten with 5/32” Hex Key socket.
 - Sway bar end link mount using a 18mm socket/wrench. Torque to 59 ft-lbs.



WARNING:

The system will automatically **raise/lower** the vehicle in the next procedure. Remove all obstructions and keep clear of vehicle before proceeding.



WARNING:

Before driving, it is necessary that the steering wheel and wheels are straight at position two. Adjust drag length accordingly. **Vehicle must be professionally aligned.**

CHECK FOR SYSTEM LEAKS

With all four wheels on the ground and the air springs inflated, check for system leaks using supplied Snoop (**Box 1**) on all pneumatic connections to the air springs and the regulator.

FINAL NOTES

After installation is complete, double check that all nuts & bolts are tight. Refer to the following chart for proper torque specifications.

With vehicle placed on ground, cycle steering lock to lock & inspect steering, suspension, brake lines, front & rear drive lines, fuel lines & wiring harnesses for proper operation, tightness & adequate clearance.

Have headlights readjusted to proper settings.

Have a qualified alignment center align vehicle to OEM specifications.

After first 100 miles, check all hardware for proper torque & periodically thereafter.

NOTE: Do not re-tighten nuts & bolts where thread lock compound was used.

TORQUE SPECIFICATIONS

INCH SYSTEM			METRIC SYSTEM		
Bolt Size	Grade 5	Grade 8	Bolt Size	Class 8.8	Class 10.9
5/16	180 in-lbs	240 in-lbs	6MM	60 in-lbs	108 in-lbs
3/8	30 ft-lbs	35 ft-lbs	8MM	216 in-lbs	23 ft-lbs
7/16	45 ft-lbs	60 ft-lbs	10MM	32 ft-lbs	45 ft-lbs
1/2	65 ft-lbs	90 ft-lbs	12MM	55 ft-lbs	75 ft-lbs
9/16	95 ft-lbs	130 ft-lbs	14MM	85 ft-lbs	120 ft-lbs
5/8	135 ft-lbs	175 ft-lbs	16MM	130 ft-lbs	165 ft-lbs
3/4	185 ft-lbs	280 ft-lbs	18MM	170 ft-lbs	240 ft-lbs

THE ABOVE SPECIFICATIONS ARE NOT TO BE USED WHEN THE BOLT IS BEING INSTALLED WITH A BUSHING.

COLDER CLIMATE TIPS

In the winter months, to keep your air system from freezing, we recommend adding CRC air brake antifreeze. This can be purchased at most automotive parts houses. We recommend that you add two caps (about 1 ounce) to the system through the compressor intake. To do this, you should adjust the suspension to deplete the air in the tank so the compressor will be running while you perform this process. You want to slowly add the antifreeze to the system so it has time to vaporize and coat everything. You will need to do this periodically depending on how much use the vehicle has. Generally, once every two weeks will be adequate but that can vary.

REGULATOR NOTICE

The supplied regulator will always have some small residual leak, due to how the regulator works, which means the tank pressure will decrease over time. If you are experiencing tank pressure dropping more than 5 psi overnight, the regulator may be leaking excessively. To rectify this, adjust the regulator pressure down to 20 psi, then up to 120 psi. If you desire no leakage, remove the regulator and cap the line from the tank.

AccuAir advises against adjusting the regulator over 150 psi.



PARTS APPENDIX

BOX 1		JEEP JT WIRING & PLUMBING KIT		BOX 1
QTY	ITEM #	DESCRIPTION		
1	20-18283	JEEP POWER WIRING KIT		
		QTY	ITEM #	DESCRIPTION
		1	20514	22-18 RED T-TAP 3 WAY SPLICE (29-7965)
		1	29-10974	CONNECTOR-MALE SPADE-PINK
		1	29-16735	PINK RING TERMINAL - 22-18 AWG #10 SIZED HOLE KRIMPA SEAL RING CONNECTOR -PINK
		1	29-16736	LARGE COPPER LUG - COPPER LUG 8 AWG W/ 5/16" HOLE
		1	29-16737	SMALL COPPER LUG
		1	29-16738	PURPLE SHRINK FEMALE SPADE - 22-18 AWG 1/4" FULLY INSULATED FEM QUICK CONNECT KRIMPA-SEAL
		1	29-16739	70 AMP MAXI FUSE - LITTELFUSE MAXI AUTOMOTIVE FUSE, 70A, TAN
		1	29-16743	WIREKIT DROP-IN CARD - COMPRESSOR RELAY WIRING DIAGRAM
		1	29-16876	ADD-A-CIRCUIT FUSE TAP 16 GA UL 1015 RED WIRE W/ BUTT CONNECTOR, 32VDC
		2	29-17564	3/8 HEAT SHRINK (NBI4494001)
		1	29-18282	RELAY GRD HARNESS, 24"
		1	29-18354	RUBBER GROMMET
1	29-16095	HEIGHT 4-CORNER SENSOR HARNESS		
1	29-16265	WIRE KIT POWER HARNESS		
1	29-16548	PLASTIC AIRLINE CUTTER		
1	29-16878	3/8 INCH DOT AIR LINE		
1	29-17530	8" ZIP TIES, 50 PACK		

BOX 1		JEEP JT WIRING & PLUMBING KIT		BOX 1
QTY	ITEM #	DESCRIPTION		
1	29-18212	JEEP KIT E-PLUS MAIN HARNESS		
1	29-18239	ECU TO VU4 HARNESS, 6.5 FEET		
1	29-18680	COMPRESSOR POWER EXTENSION CABLE (8FT)		
1	29-18861	1/4 INCH DOT AIR LINE		
1	29-20742	SNOOP, LIQUID LEAK DETECTOR, 2 OUNCE		

BOX 2		TPAD ASSEMBLY		BOX 2
QTY	ITEM #	DESCRIPTION		
1	20-16084	TPAD TPAD+		
1	29-16114	TPAD USB HARNESS TO ECU		
1	29-16253	TPAD+ QUICKSTART GUIDE		
1	29-16254	TPAD+ MOUNTING TEMP		

BOX 3		JEEP JT ECU ASSEMBLY		BOX 3
QTY	ITEM #	DESCRIPTION		
1	20-18345	JT ECU & CORE ASSEMBLY		
7	29-15750	M5 X 0.8 NYLON-INSERT LOCKNUT (NYLOC)		
1	29-16727	75A RELAY - POWER RELAY, DUAL CONTACTS, SPST, 12V, 75A		
4	29-17353	10-24 X 7/8" BUTTON HEAD SCREW (91306A349)		
1	29-17898	JT ECU BASE BRACKET		
1	29-18103	QUICK CONNECT COUPLER 1/4" NPT (M)		
1	29-18104	PRESSURE REGULATOR WITH FITTING		
7	29-18169	M5 X 0.8 X 12 BUTTON HEAD SCREW HEX DRIVE		



PARTS APPENDIX

BOX 3			JEEP JT ECU ASSEMBLY	BOX 3
QTY	ITEM #	DESCRIPTION		
1	29-18236	JT ECU BRACKET		
1	29-18348	1/4" NPTM - 1/4" PTC 90 DEGREE SWIVEL		

BOX 4			SPEED MODULE	BOX 4
QTY	ITEM #	DESCRIPTION		
1	29-18175	JEEP JL/JT OBDII SPEED MODULE		
1	29-18474	JEEP JL/JT OBDII SPLITTER		

BOX 5			JEEP JT INFLATION BRACKET ASSEMBLY	BOX 5
QTY	ITEM #	DESCRIPTION		
1	20-18490	1/4 PTC INLINE FILTER, STRAIGHT		
1	20-20541	VU4 WITH CHECK VALVE & PORT SCREENS		
1	21-18500	BRACKET ACCESSORY BAG		
4	29-15894	FLAT WASHER, M8		
1	29-16008	BRASS PRESSURE SENSOR 1/8-27 NPT, 200 PSI		
4	29-16072	VU VU4 MOUNTING NUT		
3	29-16535	3/8" DOT/PTC - 1/4" 90 DEGREE SWIVEL ELBOW		
2	29-17004	1/4" PUSH-TO-CONNECT TO SEALED 1/8" NPT STRAIGHT FITTING		
1	29-17024	SEAMLESS ALUMINUM TANK WITH 5 1/4" PORTS WITH HARDWEAR 32" X 6.625"		
1	29-17872	JT 5 GAL TANK BRACKET FRAME MOUNT		
1	29-18109	SOLENOID VALVE		
2	29-18159	#8-32 X 3/8" BUTTON HEAD SCREW HEX DRIVE		

BOX 5			JEEP JT INFLATION BRACKET ASSEMBLY			BOX 5		
QTY	ITEM #	DESCRIPTION						
4	29-18160	M8 X .125 X 20 BUTTON HEAD SCREW HEX DRIVE						
4	29-18163	#40-24 X 1.75" BUTTON HEAD SCREW HEX DRIVE						
4	29-18164	M8 NYLON-INSERT LOCKNUT (NYLOC)						
1	29-18167	1/4" TO 1/8" FNPT BUSHING						
1	29-18168	1/4" OD TO 1/4" FNPT BULKHEAD						
1	29-18238	JT INFLATION BRACKET, HANGER						
2	29-18348	1/4" NPTM - 1/4" PTC 90 DEGREE SWIVEL						

BOX 6			JEEP JT SHOCK KIT			BOX 6		
QTY	ITEM #	DESCRIPTION						
1	20-20540	75 FT. 1/4" AIR LINE						

BOX 7			JEEP JT COMPRESSOR BRACKET ASSEMBLY			BOX 7		
QTY	ITEM #	DESCRIPTION						
1	14-20442	COMPRESSOR, VIAIR 485C AIR COMPRESSOR (SINGLE PACK)						
1	29-16536	3/8" DOT/PTC - 3/8" NPT 90 DEG SWIVEL ELBOW						
2	29-17542	M5X0.8 X 12 SHCS, SS						
2	29-17543	M5X0.8 X 10 SHCS, SS						
1	29-17740	JT COMPRESSOR BRACKET, FRAME						
1	29-17742	JT COMPRESSOR BRACKET, SHIELD						
2	29-17743	M10 X 1.5 X 20 LG SERRATED FLANGE HEX HEAD						
2	29-17884	3/8" FEMALE NPT TO 3/8" PTC						
2	29-18102	COMPRESSOR ISOLATOR BRACKET						



PARTS APPENDIX

BOX 7 JEEP JT COMPRESSOR BRACKET ASSEMBLY BOX 7		
QTY	ITEM #	DESCRIPTION
4	29-18162	M6 X 1 X 50 BUTTON HEAD SCREW HEX DRIVE
4	29-9727	NYLOC NUT-ZINC-STEEL-M6 X 1 THREAD-10MM WIDE-6MM HIGH
1	29-9833	ACCY KIT-VIBRATION ISOLATOR-24 PCS

BOX 8 JEEP INFLATION ACCESSORY KIT BOX 8		
QTY	ITEM #	DESCRIPTION
2	29-20729	MOJAVE TOP-MOUNT
4	29-20924	BUSHING SLEEVE SPACER 0.95_OD
2	29-20925	SLEEVE EYELET BUSIHNG 1.56_W 0.5_ID

BOX 9 JEEP JT AIR SPRING KIT, BOX A BOX 9		
QTY	ITEM #	DESCRIPTION
1	20-15758	JEEP JL/JT AIR SPRING, FRONT
1	20-16968	JEEP JT AIR SPRING, REAR
1	20-16969	JEEP JT REAR BUMP STOP SPACER ASSEMBLY
1	20-17452	JEEP JL/JT RIDE HEIGHT SENSOR ASSY FRONT LEFT
1	20-17453	JEEP JL/JT RIDE HEIGHT SENSOR ASSY FRONT RIGHT
1	20-17613	JEEP JT RIDE HEIGHT SENSOR ASSY, REAR RIGHT
1	20-17614	JEEP JT RIDE HEIGHT SENSOR ASSY, REAR LEFT

BOX 9			JEEP JT AIR SPRING KIT, BOX A			BOX 9		
QTY	ITEM #	DESCRIPTION						
1	20-19896	JEEP JT KIT PAPERWORK						
QTY	ITEM #	DESCRIPTION						
1	11-A-WEBREF	ACCUAIR WEB REFERENCE SHEET						
1	29-16249	ACCUAIR PRODUCT REGISTRATION CARD						
1	29-21019	JEEP JT MOJAVE INSTRUCTIONS						
1	29-18894	OFFROAD INSTRUCTION AND WARRANTY FOLDER						
1	29-18914	MODIFIED VEHICLE VISOR WARNING STICKER						
1	29-19244	ACCUAIR 5" TALL VERTICAL DIE CUT						
1	29-19804	ACCUAIR 5" DIE CUT STICKER - WHITE						

BOX 10			JEEP JT AIR SPRING KIT, BOX B			BOX 10		
QTY	ITEM #	DESCRIPTION						
1	20-15758	JEEP JL/JT AIR SPRING, FRONT						
1	20-16968	JEEP JT AIR SPRING, REAR						



PARTS APPENDIX

BOX 10		JEEP JT AIR SPRING KIT, BOX B		BOX 10
QTY	ITEM #	DESCRIPTION		
1	21-17854	AIR SPRING HARDWARE KIT JEEP, JT		
		QTY	ITEM #	DESCRIPTION
		2	20-18827	1/4 TO 1/4 RESIDUAL PRESSURE VALVE PTC UNION
		2	29-15748	GROMMET, AIR HOSE
		4	29-15952	M8 OVERSIZED WASHER
		2	29-16558	HAIRPIN CLIP
		6	29-16874	5/16 - 18 NYLON-INSERT LOCKNUT (NYLOC)
		2	29-18160	M8 X .125 X 20 BUTTON HEAD SCREW HEX DRIVE
		2	29-18164	M8 NYLON-INSERT LOCKNUT (NYLOC)
		1	29-18286	JT AIR SPRING LOCKER, REAR, LEFT
		1	29-18289	JT AIR SPRING LOCKER, REAR, RIGHT
1	21-17908	JT RIDE HEIGHT SENSOR HARDWARE		
		QTY	ITEM #	DESCRIPTION
		2	29-16870	BOLT 10-32 X 1", ZINC
		2	29-17495	#10 FLAT WASHER, 0.195" ID, 0.354" OD, 0.066" THK
		2	29-17501	10-32 X 1" LG SHCS
		2	29-18330	10-32 X 1-3/4" SHCS
		2	29-18331	1" SPACER, FOR #10 SCREW, 5/16" OD
		4	29-2702	10-32 HEX NYLON-INSERT LOCKNUT (NYLOC)
		2	29-6060	M6X1 NUT
1	29-19245	ACCUAIR 23" WIDE WHITE BANNER		

BOX 11		JEEP JT CONTROL ARM KIT ASSEMBLY		BOX 11
QTY	ITEM #	DESCRIPTION		
2	29-15855	SWAY BAR END LINK, FRONT		
2	29-16974	SWAY BAR END LINK, REAR		
4	29-18226	NUT A8 (D4) M12 X 1.5 THREAD		
1	29-18254	ARN999 JL LWR FRONT DRV LK		
1	29-18255	APN999 JL LWR FRONT PASS LK		
1	29-18257	FRT ADJUSTABLE TRACK BAR		
1	29-18262	HDWR BAG: JL24LLF		
1	29-18265	HDWR BAG: JLFTBB X 2		
2	29-18463	JTG REAR LOWER LINK 2-4.5"		
1	29-18465	JTG REAR TRACK BAR BRACKET		
1	29-18468	HDWR BG: JT REAR TRK BAR BK		
4	29-20436	ACCUAIR CONTROL ARM BADGE		
1	29-20458	JEEP JT DRIVER REAR UPPER LINK		
1	29-20459	JEEP JT PASSENGER REAR UPPER LINK		
1	29-20735	JEEP 2024+ SWAY BAR SPACER		

BOX 12		JEEP JT SHOCK KIT		BOX 12
QTY	ITEM #	DESCRIPTION		
1	29-19810	JRI SHOCK KIT JT		



PARTS APPENDIX

BOX 13		JEEP INFLATION ACCESSORY KIT		BOX 13
QTY	ITEM #	DESCRIPTION		
1	29-18105	BLOW GUN		
1	29-18125	CLIP ON SCHRADER CONNECTION		
1	29-18126	30FT BRAIDED HOSE		
1	29-18131	1/4" NPT QUICK CONNECT STUD (M)		

ACCUAIR

SUSPENSION



TROUBLESHOOTING & TECHNICAL SUPPORT

MORE INFO?
ACCUAIR DOCUMENT LIBRARY



www.AccuAir.com | 888.234.6698
Monday - Friday 8:00AM - 6:00 PM (EST)
200 Sea Ray Drive, Merritt Island, FL 32953