

Big Game
hunters



PLAYHOUSE



CaFé Shop
PLAYHOUSE
INSTRUCTIONS

Before Installation

Check all parts are present!

Our factory takes every effort to make sure everything is packed in its proper place. But just in case a small part has gone astray please make sure you check every piece is present before you begin installing - right down to the screws.

Assemble with Care

Installation should be completed by two adults. Please make sure you follow all the instructions carefully. If you have any questions during installation please do not hesitate to contact us.

Please make sure you read all the safety warnings and advice in this instruction manual.

Install the playhouse on a level surface and ensure it is at least 2m away from other structures and obstacles such as houses, garages, fences, branches, clothes lines or electrical wires. Never place the playhouse on a wet or loose surface. Never place the playhouse on a hard surface like concrete or asphalt. A fall from a playhouse onto a hard surface like this could result in serious injury. Any modifications made by the consumer must be carried out according to the manufacturer's instructions.

Please follow the warnings to ensure proper use of this playhouse and ultimately to ensure full enjoyment!



Remember...

We strongly recommend looking after these instructions, after all without them it will be a bit tricky to put this product together. Even though we know our customers are more intelligent than most, we still think you may find these instructions useful. *But if something unexpected were to happen, such as,*

Your dog ate them or...

your children constructed a kite out of them?

Maybe your neighbour ran over it with their car?

You would have nothing to fear because we have uploaded all of our instructions to our website:
www.biggamehunters.co.uk

Tools Required

Benötigtes Material / Accessoires / Herramientas
Strumenti da lavoro / Benodigdheden



Parts Included

Unterteile / Liste des pièces / Lista de partes
Elenco degli elementi / Onderdelen

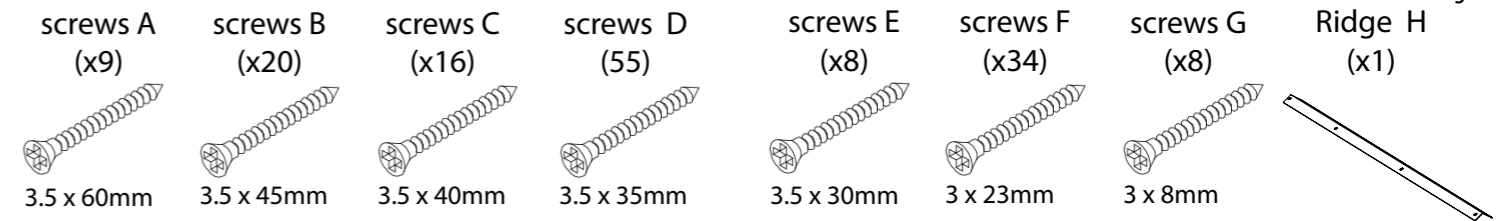

*Please Note: Right and Left are referring to the side the part is on, as you LOOK at that particular panel.

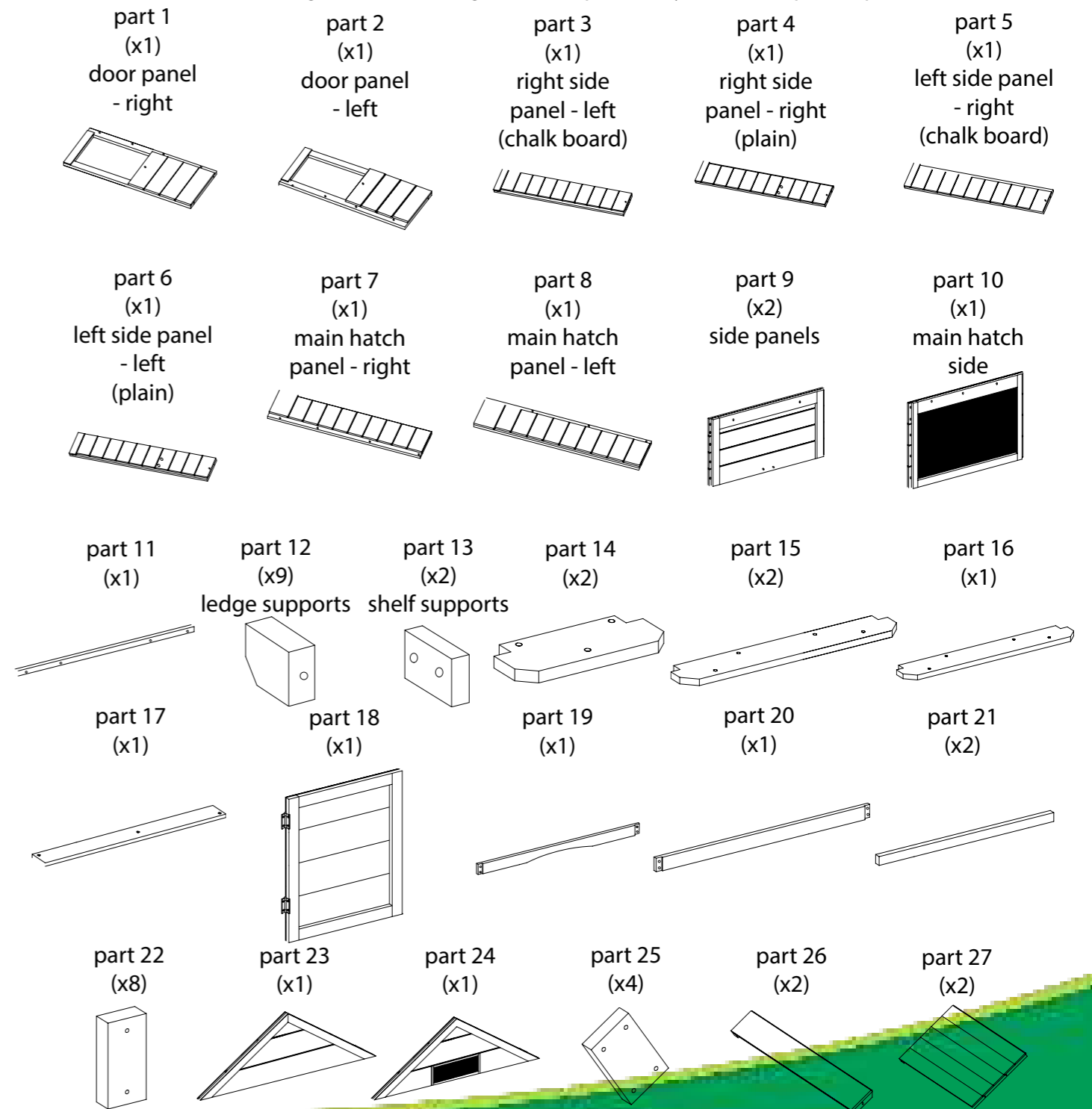

*we recommend using an electric screwdriver for ease, but a manual will work - you will just need a little more elbow grease!

1**Assemble the Corners**

You will need:
 Parts 1, 2, 3, 4, 5, 6, 7, 8
 16 x Screws 'C' (3.5 x 40mm)

Fix part 1 to part 5 using four screws C, then fix part 2 to part 3 using four more screws C. Repeat to fix part 7 to part 6, and then part 8 to part 4. You will now have created the four corners of the playhouse.

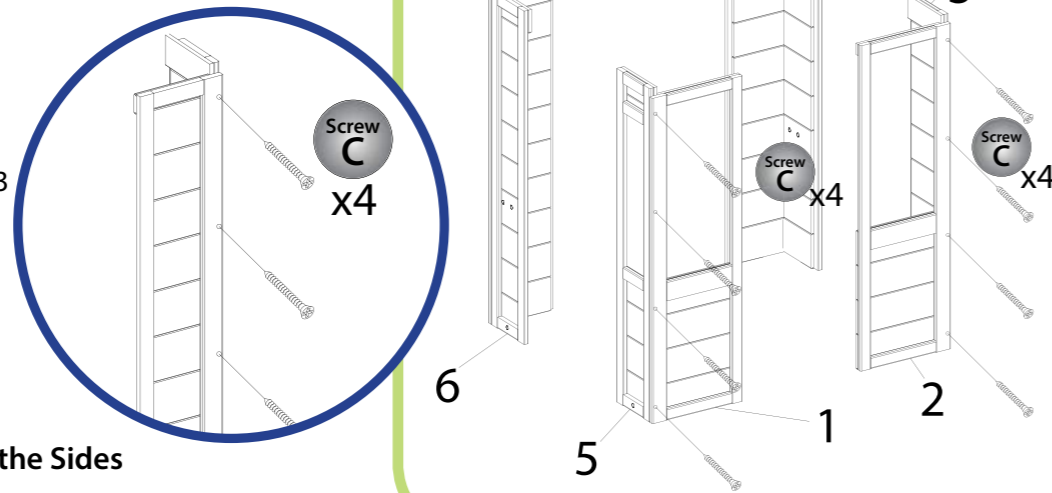
**2****Complete the Sides**

You will need:
 Parts 9, 10, 11
 30 x Screws 'F' (3 x 23mm)
 & 4 x Screws 'B' (3.5 x 45mm)

Slot parts 9 between parts 3-4 and 5-6 to create the sides. Screw from the inside using ten screws F on each side. Slot part 10 (chalk board) between parts 7-8 and fix using ten more screws F. Now fix part 11 along the bottom, underneath parts 1-2 screw in place using four screws B.

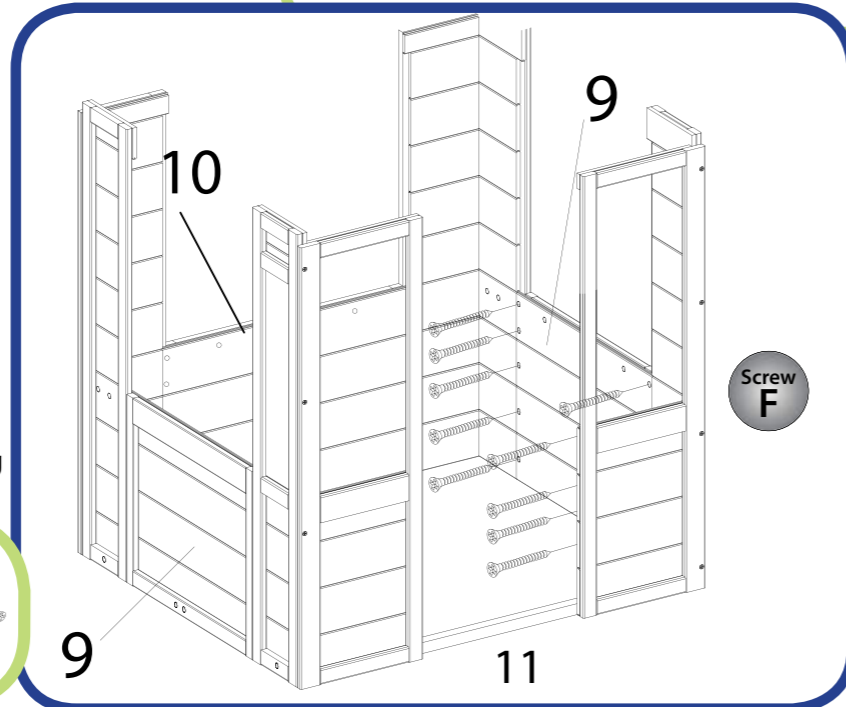
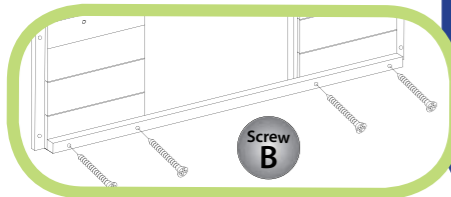
**3****Add the Shelf & Ledge Supports**

You will need:
 Parts 12 (x9), 13 (x2)
 4 x Screws 'E' (3.5 x 30mm) 8 x Screws 'A' (3.5 x 60mm)
Please Note: there are guide holes for the ledge and shelf supports on the internal panels and the supports themselves. Use these to guide your position to ensure the shelf sits level.
 Fix two parts 12 to the outside of each side panel, using four screws A - screw from inside the house. Repeat this for the chalk board as shown in the 'Rear View' diagram - attaching the final part 12 to the inside of the house.
 Add two more on the small panels (parts 1 & 2, next to the door panel), this time on the inside - screwing from outside the house. Ensuring the top of part 13 is 430mm from the base of the playhouse, fix these inside each side panel, adjacent (at right angles) to the chalkboard using two screws E on each side - these create the internal shelf supports.

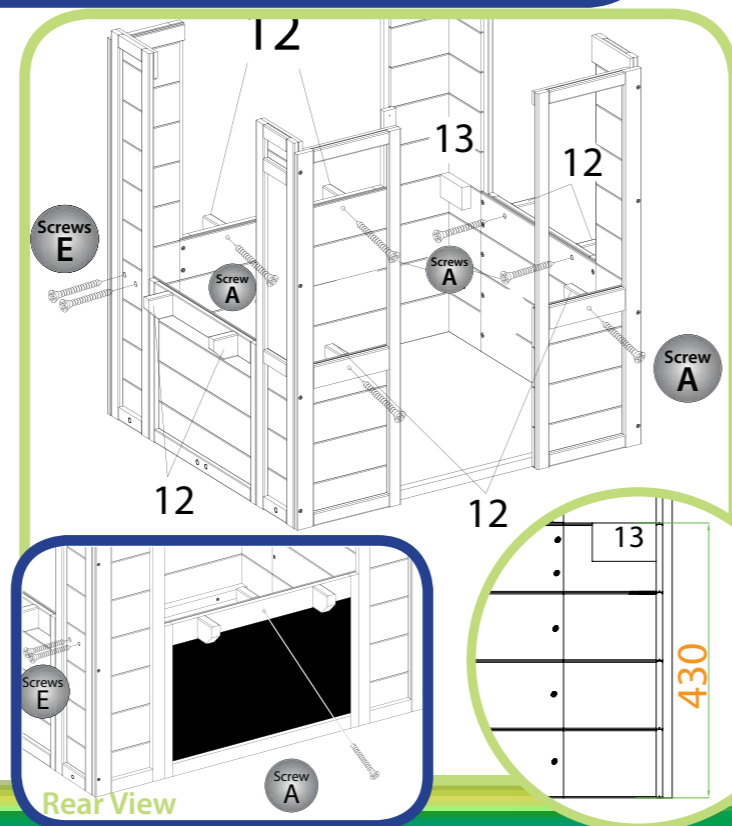
**4****Attach Door & Shelves**

You will need:
 Parts 14 (x2), 15 (x2), 16, 17 & 18 (door)
 23 Screws 'D' (3.5 x 35mm) - for all shelves & ledges
 4 x Screws 'F' (3 x 23mm) - for the door

Fix part 18 (door) in place using four screws F. The door opens outwards.

Attach the smaller ledges (parts 14) either side of the door using three screws D on each. Fix the main external ledges (parts 15) on each side using four screws D on each. Fix the final external ledge (part 16) on the chalk board panel using four screws D. Lay the internal shelf (part 17) on top of the supports added in step 3 (part 13). Fix in place using five screws D.

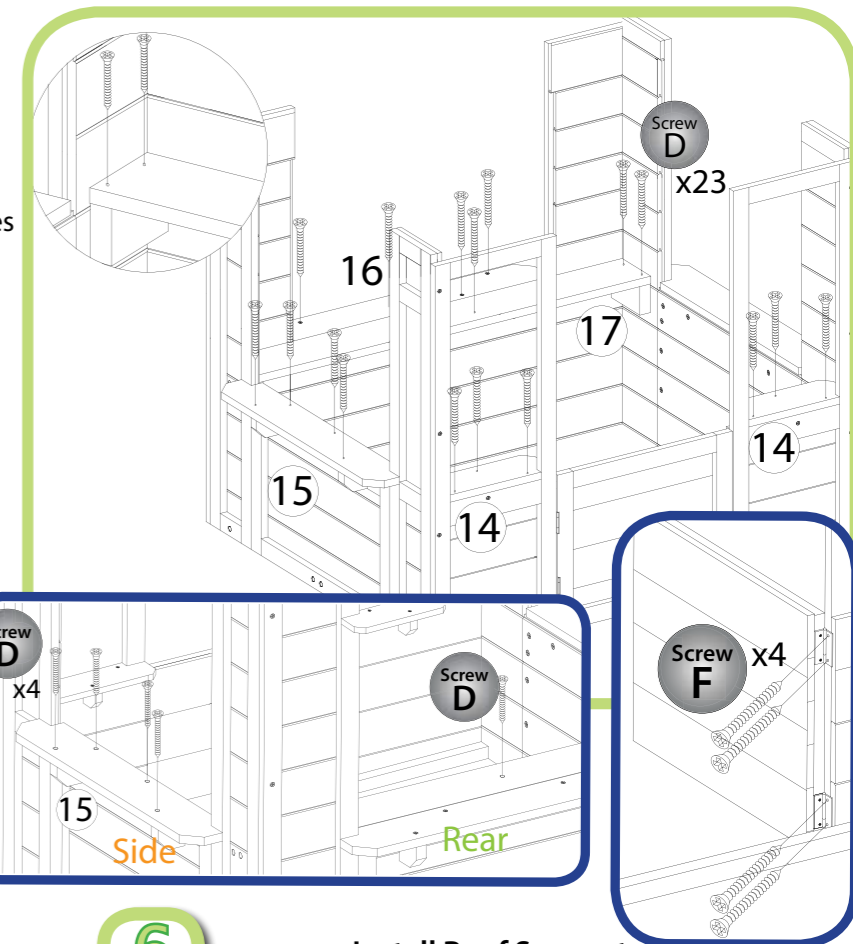
**5****Add the Roof Supports**

You will need:
 Parts 19, 20, 21, 22
 16 x Screws 'D' (3.5 x 35mm)
 4 x Screws 'B' (3.5 x 45mm)
 4 x Screws 'E' (3.5 x 30mm)

Place parts 21 along the top of each side panel and fix with two parts 22 and four screws D on each (screw from inside). Fix part 19 along the top and secure with two parts 22 and 4 screws D. Repeat for part 20 opposite. Use four screws B and four screws E on the front and back to secure the ends as shown (B above and E below).

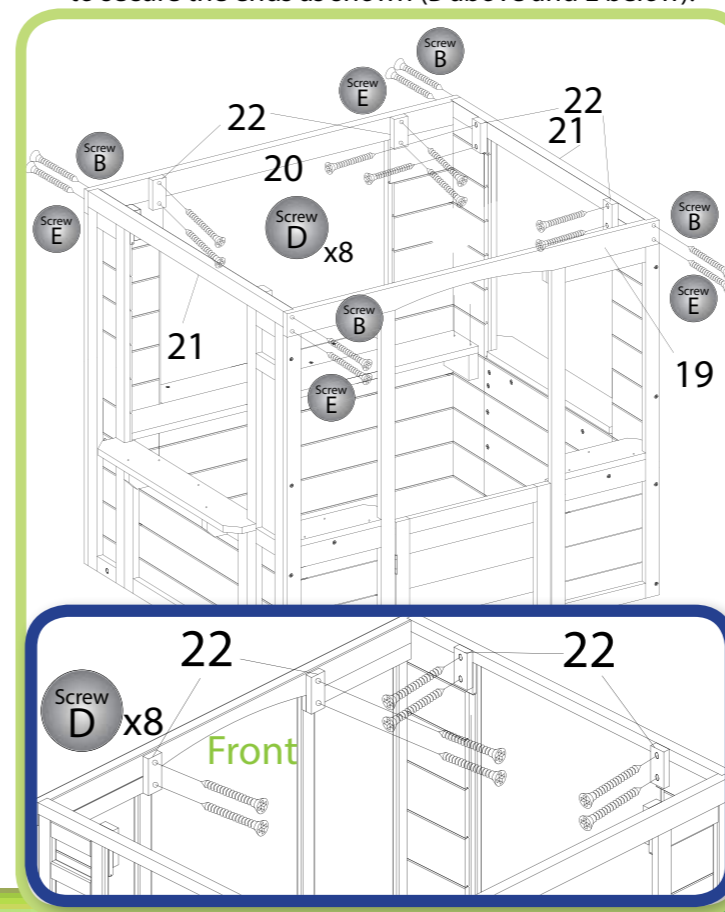
**6****Install Roof Supports**

You will need:
 Parts 23, 24, 25
 16 x Screws 'D' (3.5 x 35mm)
 Add the triangular part 24 (above the shop front panel) and secure in place using a part 25 and four screws D on each side. Repeat on the opposite side with part 23.

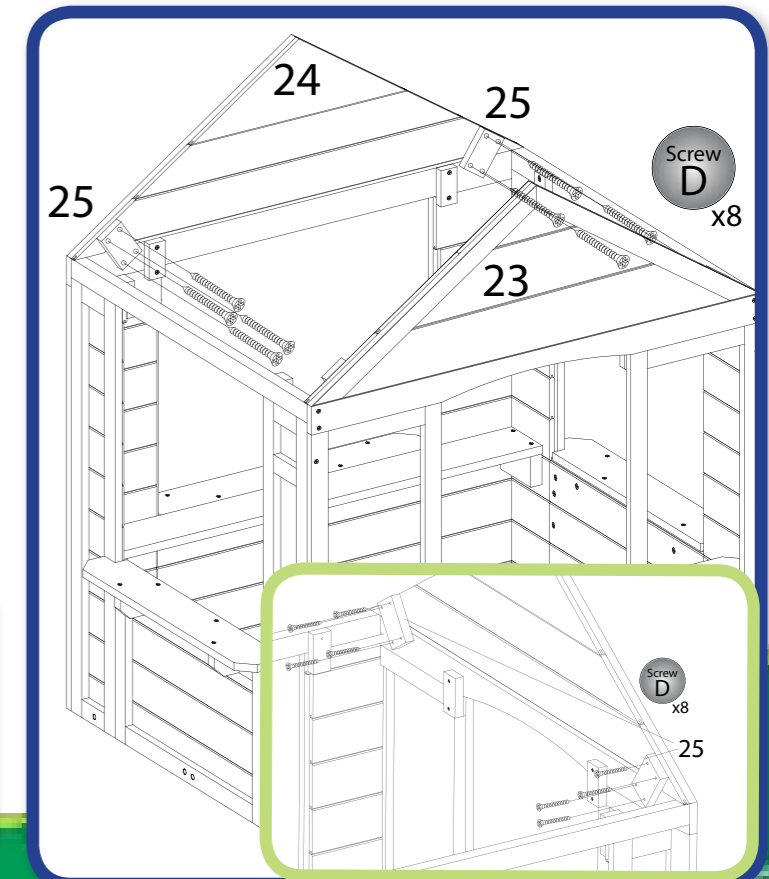

7

Add the Roof Ridge

You will need:

Parts 26 (x2)
4 x Screws 'B' (3.5 x 45mm)

Place the roof supports (parts 14) on top of the triangular panels and secure using two screws B on each end.

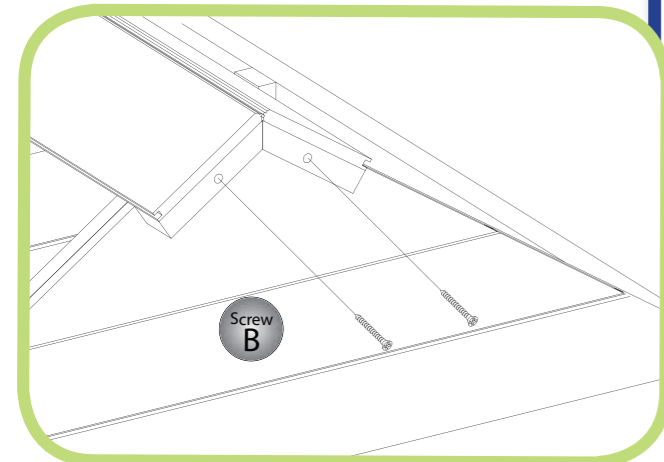
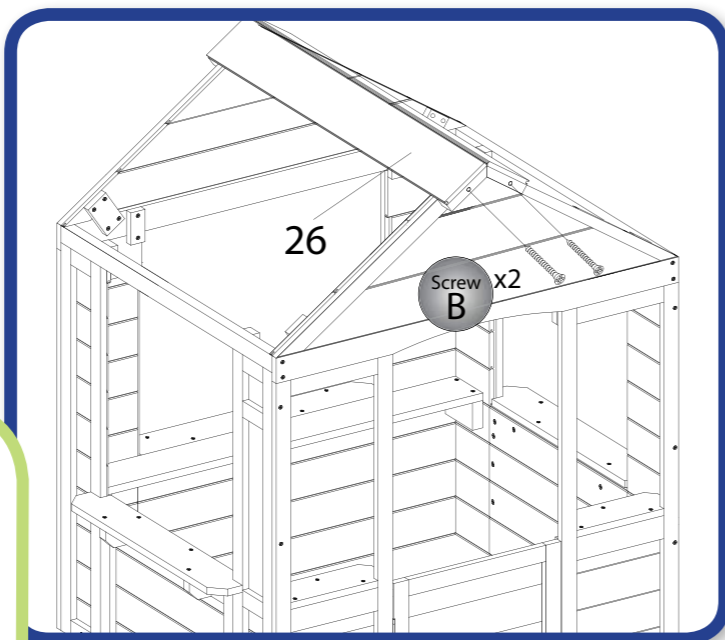

8

Add the Roof Panels & Strip

You will need:

Parts 27 (x2) and Part H
8 x Screws 'B' (3.5 x 45mm)
8 x Screws 'G' (3.5 x 8mm)

Slot the roof panels (parts 27) into the roof ridge and fix in place using eight screws B - two at the end of each panel.

Lay the plastic roof strip on the roof. Following the premade holes in the plastic strip, fix down using eight screws G..

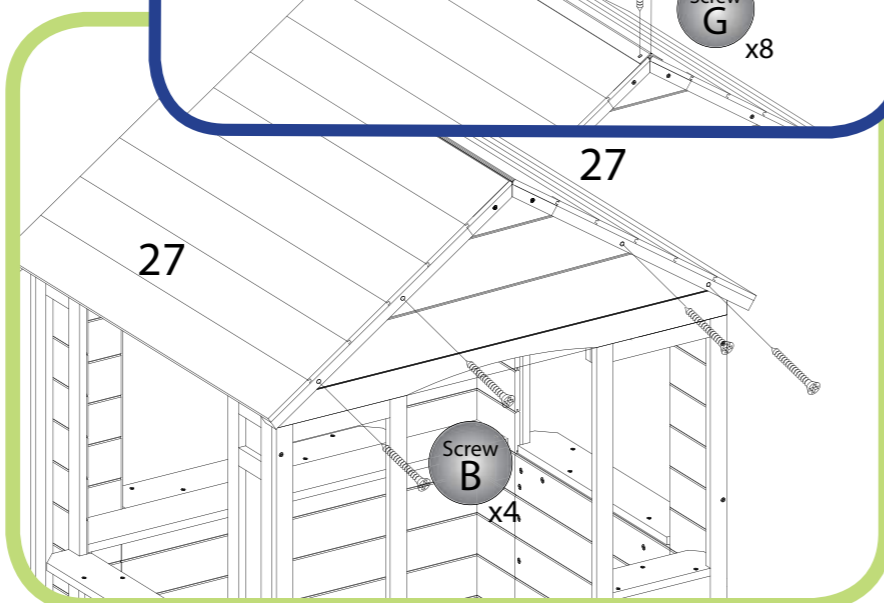
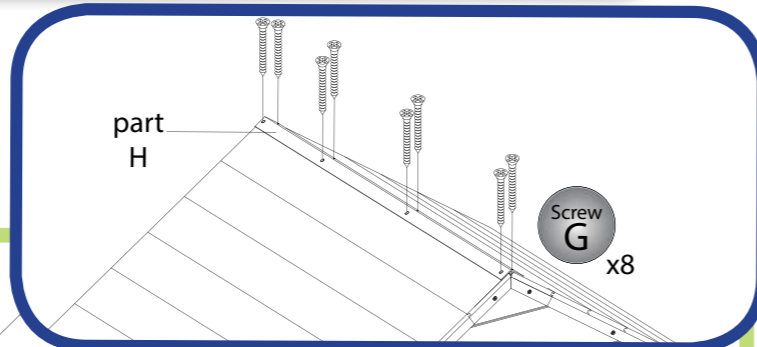

9

Add the Floor

You will need:

Optional Floor Panels
8x Floor Screws: 3.5 x 50mm

If you have not purchased the floor this won't apply to you.

Lay the two floor panels inside the playhouse and screw in place using 4 screws on each side.

*The floor panels lay along the width of the playhouse.

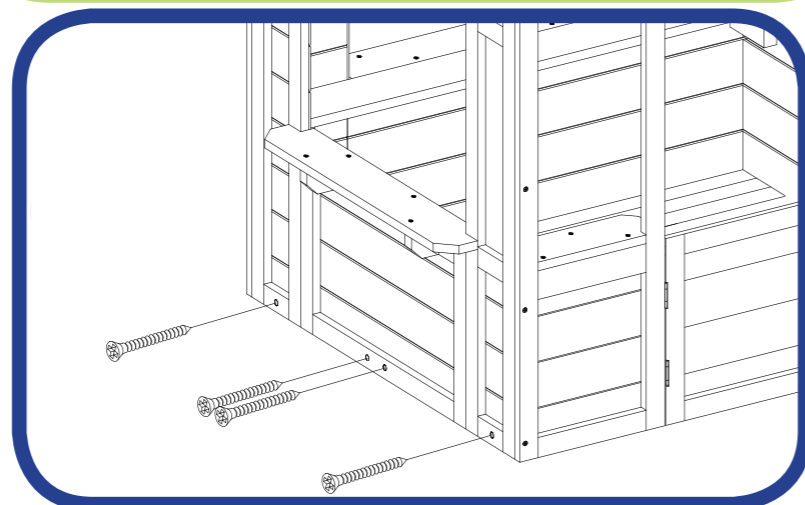

Now make sure all the screws are tightened and your playhouse is situated somewhere flat, well drained and safe - following the instructions on page 2. Then the playhouse will be ready for your little one's many adventures!



Inspection & Maintenance

We recommend the following maintenance.

Looking After Your Playhouse

Your playhouse is made from heat-treated natural wood. It is also sourced from sustainable forests. The playhouse should be treated on assembly with a wood preserver and it is strongly recommended that you re-treat it once a year to extend the life of your playhouse. On rare occasions, when you first erect the playhouse in wet conditions and where it is wet or rainy for a prolonged time, then followed by a burst of sunshine, it is possible to get some mould on some panels. Please be reassured that this can be washed off with a mould cleaner or wiped down with a baking soda solution. Baking soda is a natural disinfectant and very mild, so this solution cleans mould without leaving a scent. Dissolve baking soda into a water and vinegar solution, spray onto the surface, let it sit for a little while and then wipe with a damp cloth.

Weekly to monthly / routine inspection

Regularly check the playhouse for splinters and any signs of wear and tear. It is important to regularly check all parts, including the crossbeams, supports and panels. **If regular checks on the playhouse are not carried out, the unit could overturn or otherwise become a hazard.** It is important to check all screws and tighten or replace where necessary.

The following inspection and maintenance should be carried out after assembly and then at least twice a month while in use and at the start of each season;

- check all nuts and bolts for tightness and tighten when required;
- replace defective parts in accordance with the manufacturer's instructions.

Warnings!

 **The playhouse is designed for children between 18 months - 10 years old only. The playhouses are designed for use by two children with a combined weight of 100 kg. Do not climb or play on the roof of the playhouse. Only for domestic use! Designed for outdoor use only!**

 **Warnung! Das Spielhaus ist nur für Kinder zwischen 18 Monaten - 10 Jahren geeignet. Die Spielhäuser sind für zwei Kinder mit einem Gesamtgewicht von 100 kg ausgelegt. Klettern oder spielen Sie nicht auf dem Dach des Spielhauses. Nur für den Hausgebrauch! Nur für den Außenbereich geeignet!**

 **Attention! Le théâtre est conçu pour les enfants entre 18 mois - 10 ans seulement. Les playhouses sont conçus pour être utilisés par deux enfants avec un poids combiné de 100kg. Ne grimpez pas et ne jouez pas sur le toit de la salle de spectacle. Pour usage domestique seulement! Conçu pour une utilisation en extérieur seulement!**

 **iAdvertencia! La casa de juegos está diseñada para niños de entre 18 meses - 10 años solamente. Los teatros están diseñados para ser utilizados por dos niños con un peso combinado de 100 kg. No trepe ni juegue en el techo de la casa de juegos. ¡Exclusivamente para uso doméstico! Diseñado solo para uso al aire libre!**

 **Attenzione! La casetta è progettata per bambini tra i 18 mesi - 10 anni. Le casette sono progettate per essere utilizzate da due bambini con un peso combinato di 100 kg. Non salire o giocare sul tetto della casetta. Solo per uso domestico! Progettato solo per uso esterno!**

 **Waarschuwing! Het speelhuis is ontworpen voor kinderen tussen 18 maanden - 10 jaar oud. De speelhuizen zijn ontworpen voor gebruik door twee kinderen met een gecombineerd gewicht van 100 kg. Klim of speel niet op het dak van het speelhuisje. Alleen voor huishoudelijk gebruik! Alleen ontworpen voor gebruik buitenshuis!**

ARE YOU a PLAY EXPERT?

Take a photo and share it with us using **#littleplayexpert** or **#bigplayexpert** and be part of our growing network of play experts! Thousands of people every day are showing us that they are truly expert at play and playing in so many different ways - are you?



42 likes

@theplayexperts Literally jumping for joy! I think we are seriously #bigplayexpert s! #nevertooold #foreveryoung



107 likes

@theplayexperts our niece and daughter enjoying a game at a family wedding. Never too young for chess!



94 likes

loving the hi tower challenge @theplayexperts - its harder than it looks! #bigplayexpert #littleplayexpert



51 likes

The concentration on their faces! #littleplayexpert @theplayexperts

Not Just PLAYHOUSES...

You may or may not be aware that we design and make many different kinds of garden games and play equipment as well as our wooden playhouse range.

Big Game Hunters has been designing and creating games for children and families since 1997 - so by now we really do know what we are doing.

Here are just a few that are great for the whole family as well as just the kids...

The Parachute Game



Giant Tower

Giant Dominoes (in a box)

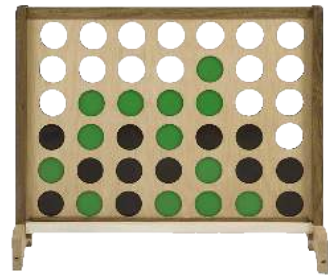
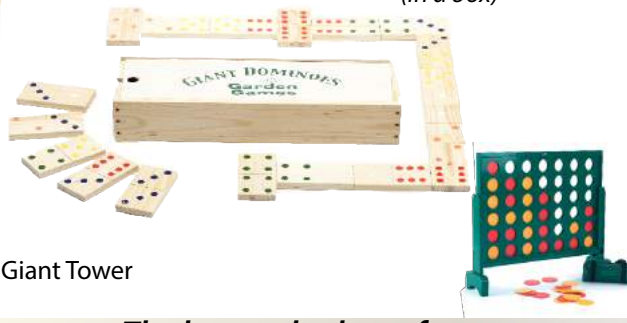

Giant Four in a Row Games; Hardwood Big 4 & Jumbo 4

The logo to look out for...

There are many more products we have created - just look out for our Big Game Hunters logo or flower emblem to be sure you have an official product. The brand is not just a logo, it is the whole family of ideas, service and quality that are behind every product. We are not a huge corporate and do not claim to be - we are proud of who we are and what we create so look out for our brand knowing that each product carrying our logo has a special standard we aim to maintain for years and years to come...



Random Factoid Bubbles

Wooden Playhouses are sometimes called 'Wendy Houses'. This is because in the play 'Peter Pan' by J. M. Barrie, Peter (the boy who never grew up) built a

small house around Wendy when she was shot in Neverland.

CE Please retain for future reference

+441865 392439
sales@biggamehunters.co.uk
biggamehunters.co.uk
@theplayexperts