

BEE-BALL 

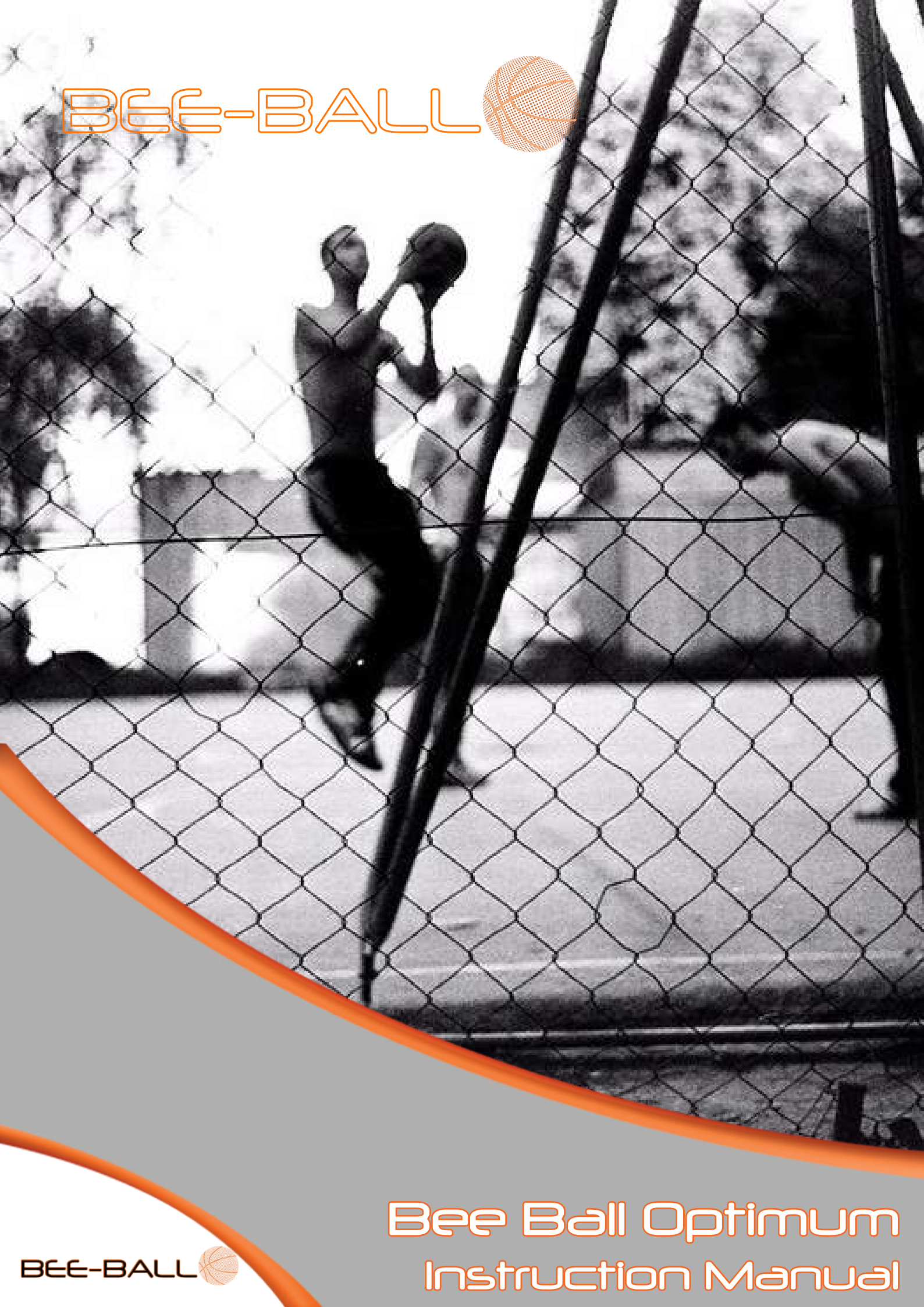

Bee Ball Optimum
Instruction Manual

BEE-BALL 

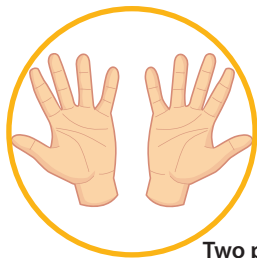

Two pairs of hands



Spanner and Socket Set

Tools Required

Benötigtes Material / Accessoires / Herramientas / Strumenti da lavoro / Benodigheden

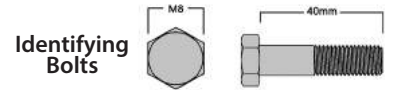

Identifying Bolts

Size	Spanner Size
M8	13mm
M10	17mm
M12	19mm
M14	22mm
M16	24mm
M18	27mm
M20	30mm

Parts Included

Unterteile / Liste des pièces / Lista de partes / Elenco degli elementi / Onderdelen



Bolt, Nut & Washer A (x1)
M12 / 160mm



Bolt, Nut & Washer B (x2)
M12 / 160mm



Bolt, Nut & Washer C (x4)
M12 / 60mm



Bolt, Nut & Washer D (x4)
M10 / 40mm



Bolt, Nut & Washer E (x1)
M8 / 70mm



Bolt, Nut & Washer F (x1)
M10 / 140mm + metal bolt cap



Bolt, Nut & Washer G (x2)
M10 / 110mm



Bolt, Nut & Washer H (x2)
M8 / 130mm



Bolt, Nut & Washer I (x4)
M8 / 25mm



Bolt & Washer J (x1)
M8 / 30mm

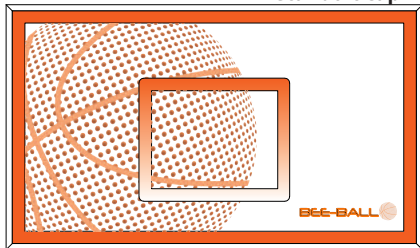

Part 1
Backboard



Part 2
Hoop/Ring



Part 3
Net



Bracket Q & Handle R

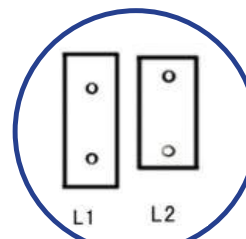

Plates L1 & L2

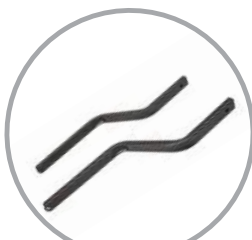

Part 4 (S)
Board Braces

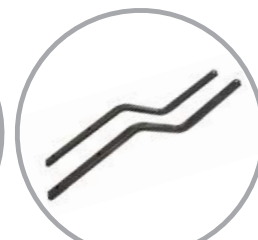

Part 5 (T)
Board Braces

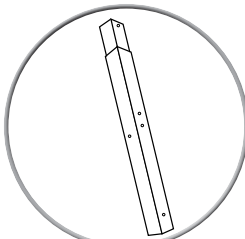

Part 6 (W)
Top Pole

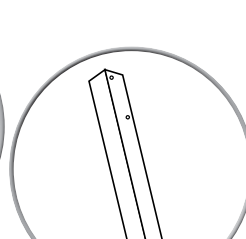

Part 7 (X)
Middle Pole

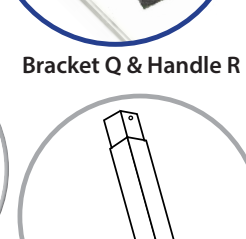

Part 8 (Y)
Bottom Pole

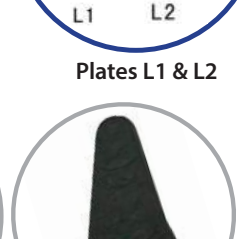

Part 13
Rebound Board



Part 9 (Z)
Adjustment Pole



Part 10
Base - comes part assembled with wheels and axle.

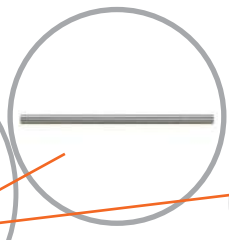

Wheels (x2)

Bottom



Parts 12 - U1, 2, 3 & 4
Base Struts (x4)

Top

Before Installation

Check all parts are present!

Our factory takes every effort to make sure everything is packed in its proper place. But just in case a small part has gone astray please make sure you check every piece is present before you begin installing - right down to the nuts and bolts.

Assemble with Care

Installation should be completed by two adults. Please make sure you follow all the instructions carefully. If you have any questions during installation please do not hesitate to contact us on +441865 392439 or email sales@biggamehunters.co.uk and we will be happy to advise.

Please make sure you read all the safety warnings and advice in this instruction manual. Take extra care and attention over the ballasting instructions as this will make sure your equipment stands firm once you have completed the assembly. We recommend the use of sand and water - if water is used anti-freeze is necessary to prevent the water from freezing and cracking the base. Make sure you position the stand somewhere where there is plenty of space to play.

Using the Basketball Equipment

Improper installation or use of the basketball stand may cause damage to the stand or result in serious injury to the user. We would advise that children are supervised at all times when using this product.

Do not use the stand in windy weather conditions - adjust to the lowest height and store to prevent any damage.

Please adhere to the warnings below to ensure proper use of this equipment and ultimately to ensure full enjoyment!

Weighing Down the Base

Making sure the base is weighted properly is very important for safety reasons.

We recommend filling your base with sand or a mixture of water and sand or fine gravel - to a total weight of 170kg.

To fill, simply remove the plastic plug/lid in the base and add water using a hose. To add sand or gravel, use a funnel - you can create a make-shift funnel using a flexible plastic board or thick glossy piece of cardboard.

If you are using water you must add anti-freeze to prevent the base from cracking during winter months. We would also recommend adding an anti-algae solution to the water to prevent algae from growing inside the base (such as bleach or chlorine).

Moving Your Basketball Stand

The stand must be moved by two adults capable of handling the weight of the stand - children should not be allowed to move the stand.

Stand in front of the basketball system and pull the pole forward slowly until the system is balanced on the wheels in the base.

Roll the stand carefully to the new location and slowly push the system back to a standing position.

Attaching the Basketball Net

When attaching the net to your basketball hoop, make sure you have the net the correct way up. The wider loops/wider part of the net should be at the top. Slide the loops of the net over the metal loops on the inside of the basketball hoop - from the inside towards the outside (see diagram 1). You can also see here a net that has been assembled correctly and one that has been assembled upside down!



diagram 1



Incorrect



Correct

Assembling Your Stand

1

Attach Ring to Backboard

You will need:

Hoop/Ring (part 2)
Backboard (part 1)

4 x Bolts, Nut & Washers D (M10 x 40mm)

First, remove the metal case from the back of the ring using a crosshead screwdriver.

Fix the Hoop/Ring (part 2) to the front of the Backboard (part 1) using Bolts, Nuts & Washers D.

The bolts go through the back of the backboard then through the ring and are fixed in place using the nuts. Now put the metal case back on the ring.

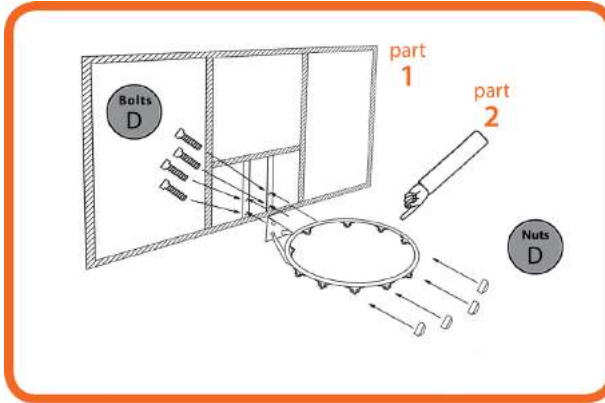

2

Attach Backboard Braces

You will need:

Parts as assembled in Step 1
Backboard Braces (parts 4{S} & 5{T})

4 x Bolts, Nuts & Washers C (M12 x 60mm)

Attach the Backboard Braces (parts 4 & 5) to the backboard using four Bolts, Nuts and Washers C. Braces S (parts 4) go at the top of the backboard - furthest away from the ring.

Attach using the Bolts/Nuts in this order:

Bolt > Washer > Brace > Washer > Backboard > Washer > Nut

Please Note: These bolts need to be tightened to the right level. If they are too tight, it will be impossible to adjust the height of the backboard and too much pressure will be put on the stand.

Tighten the nuts up until you can feel a resistance and then loosen a little bit, the braces should move freely.

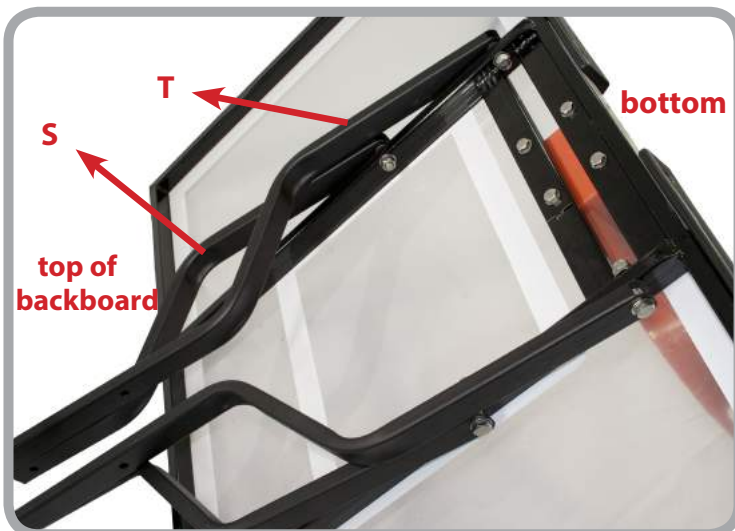

3

Join the Top Pole and Braces

You will need:

Parts as assembled in Step 1 & 2

Top Pole (part 6 - W)

2 x Bolts, Nuts & Washers B (M12 x 160mm)

Making sure the Top Pole is the right way round (highest hole must be furthest from backboard), fix the ends of the Backboard Braces (parts 4 & 5) to the Top Pole (part 6 - W) using two Bolts, Nuts and Washers B. Again, don't overtighten - follow our tip in Step 2 to ensure the braces can move (very important for adjusting the height of the backboard).



4

Add the Adjustment Pole and Middle Pole

You will need:

Parts as assembled in Step 1, 2 & 3

Adjustment Pole (part 9 - Z)

Adjustment Handle (part R)

Middle Pole (part 7 - X)

Bracket (part Q) - and metal plates (parts L1 & L2)

1 x Bolt, Nut & Washers A (M12 x 160mm)

1 x Bolt, Nut & Washers G (M10 x 110mm)

2 x Bolts, Nuts & Washers H (M8 x 130mm)

a. Attach the Adjustment Pole (part 9 - Z) to the free hole at the end of the Board Brace (part 5 - T) using one Bolt, Nut and Washers A.

b. Add the Adjustment Handle (part R) to the bottom of the Adjustment Pole (part 9)

c. Attach the Middle Pole (part 7) to the top pole using one Bolt, Nut & Washer G.

d. Attach Bracket (part Q) to the middle pole using two Bolts, Nuts & Washers H and the two rectangular metal plates (parts L1 and L2).



5 Attach the Base & Bottom Pole

You will need:

Bottom Pole (part 8 - Y) and Pre-assembled Backboard, Top Pole and Middle Pole from Steps 1 - 4

- 1 x Bolt J (M8 x 30mm)
- 1 x Washer J
- 1 x Bolt, Nut & Washer G (M10 x 110mm)

Fix the Bottom Pole (part 8 - Y) to the Base (part 10) using one Bolt and Washer J. Then lay the bottom pole and base on its side.

Carefully laying the pre-assembled parts from Steps 1 - 4 on their side, attach the Bottom Pole and Middle Pole



6 Attach the Base Struts

You will need:

- Pre-assembled parts from Step 1 - 5
- 1 x Bolt, Nut & Washers F & plastic bolt cap (M10 x140mm)
- 4 x Base struts (parts 12: U1, U2, U3 & U4)
- 4 x Bolts, Nuts & Washers I (M8 x 25mm)

Attach the top ends of the Base Struts (parts 12) to the Middle Pole (near bracket Q) using one Bolt, Nut and Washers F. U1 & U2 stay on the inside (touching Middle Pole) and U3 & U4 on the outside. Finish by adding the plastic bolt cap. Now secure the bottom ends of struts U1 & U2 on the two sides of the base and U3 & U4 to on the front of the base using four Bolts, Nuts and Washers I.



7 Completing the Stand

You will need:

- 1 x Rebound Board
- Assembled Basketball Stand

Place the rebound board above your base (against the base struts) as pictured. Secure in place using the velcro straps on the reverse of the board (see image below).



Using two capable adults, raise the stand so it is standing upright on its base. Tighten all your nuts once again to make sure everything is secure. Follow the instructions on filling your base to ensure it is weighed down correctly.



Warning!

Failure to comply with these warnings can lead to injury and/or damage of the basketball equipment.

- Do not allow children to hang from the hoop/rim, climb on the basketball base or up the pole
- Do not perform 'dunk' moves on this basketball stand as it is not designed for this purpose. During play ensure face does not come close to the backboard, rim or net as this could result in injury.
- Do not allow children to move or adjust the system
- Never leave the unit standing upright without proper weight in or on the base to support it
- Make sure you check the base frequently to ensure there is proper support for the stand (see the *Inspection and Maintenance* section below)
- Make sure the pole sections are correctly installed - failure to do this could cause the poles to separate during play or transportation
- The surface beneath the base must be smooth and free of gravel or other sharp objects - punctures cause leakage and could cause the system to tip over
- Check the system before use to make sure all fixtures and fittings are tight (see *Inspection and Maintenance* below)
- During play, do not wear jewellery (e.g. rings, watches, necklaces) objects may become entangled in the net
- Adverse weather conditions, exposure to extremes of weather, corrosive materials such as salt, herbicides or pesticides or misuse of the stand could cause corrosion and result in the system failing
- This equipment is intended for home recreational use only and NOT excessive competitive play
- We recommend storing your stand in a cool, dry place to extend the life of your equipment

Inspection & Maintenance

We recommend the following inspection and maintenance.



Looking After Your Basketball Stand

Your basketball stand - just like any other outdoor play equipment - is designed to be used outside but without proper care and maintenance will not last as long as you might want.

Weekly to monthly / routine visual inspection

Check all nuts and bolts - if any are loose, tighten them where necessary.

Check the base for any cracks or leakage

Check all pole sections for visible rust and corrosion.

If you find any corrosion, rust, chips or cracks, use an emery cloth to remove the rust or chipped paint, and clean the area with a damp cloth. Once it is dry apply two coats of a rust preventative high gloss enamel paint (suitable for metal) to the area. Allow the paint to dry between coats and ensure it is completely dry before the stand is used.

1 -2 times per year / annual inspection

Check for rust and corrosion of nuts and bolts and replace with galvanised steel replacements where necessary.

Warning!

 **For family domestic use only. Not suitable for children under 3 years / 36 months because of small parts which could be a choking hazard. To be used under the supervision of an adult.**

Install the product in a way to avoid risk of entrapment - with sufficient gap between the product and other surfaces.

 **Warnung! Nur für den häuslichen Gebrauch. Für Kinder unter 3 Jahren / 36 Monaten der Deckel ist nicht geeignet, wegen verschluckbare Kleinteile. Durch verschluckbare Kleinteile besteht Erstickungsgefahr. Nur unter der direkten Aufsicht eines Erwachsenen benutzen. Bei der Montage des Produktes in ein Spielgerät oder eine andere Konstruktion muss sichergestellt werden, dass keine Fangstellen für Gliedmasse oder Kleidungsstücke entstehen.**

 **Attention! Exclusivement à usage familial. Ne convient pas aux enfants de moins de 3 ans / 36 mois, présence de petits éléments susceptibles d'être ingérés ou inhalés - risque d'étouffement.. À utiliser sous la surveillance rapprochée d'un adulte. Au cas où l'on incorpore le produit dans un jeu ou une construction quelconque, il faudra le faire de façon à éliminer tout risque de coincage.**

 **iAdvertencia! Exclusivamente para uso doméstico. No conveniente para menores de 3 años / 36 meses - partes pequeñas con riesgo de ingestión o inhalación - riesgo de atragantamiento.. Se utilizará exclusivamente bajo la vigilancia directa de una persona adulta. La instalación de este producto en un juego infantil o otra construcción debe estar hecho así que peligro para quedarse atascado quede excluido.**

 **Attenzione! Solo per uso domestico. Non adatto ai bambini di età inferiore a 3 anni / 36 mesi - presenza di piccoli elementi suscettibili di ingestione o inalazione - pericolo di soffocamento.. Utilizzare sotto la sorveglianza diretta di un adulto. Effettuare il montaggio in modo che si eviti il rischio di intrappolamento.**

 **Waarschuwing! Alleen voor privé gebruik. Niet geschikt voor kinderen jonger dan 3 jaar / 36 maanden wegens kleine elementen met het risico op inslikken of inademen - verstikkingsgevaar. Alleen voor privé gebruiken onder toezicht van een volwassene. Het inbouwen van dit product in een speeltoestel of andere constructie dient zodanig te gebeuren dat voor beknelling uitgesloten is.**

Not just Basketball...

You may or may not be aware that Bee-Ball is exclusive to the retailer Big Game Hunters who not only have a huge range of high quality basketball equipment but are also owners of the UK's leading sports ball retailer.

Sports Ball Shop

Part of the Big Game Hunters group 

Big Game Hunters' Sports Ball Shop sells a wide range of balls and sports training equipment including basketballs. To browse their range go to sportsballshop.co.uk.

Alongside a wide range of basketball and sports equipment Big Game Hunters also manufacture and sell a wide range of other outdoor toys, games and play equipment. Having been in the game since the year 1998 as a retailer we have a lot of experience and expertise in this area.

Some of our other ranges include...

Skyhigh Trampolines



Wooden Playhouses



Giant Games



Climbing Frames



information on these and other products can be found at:

www.biggamehunters.co.uk

Big Game Hunters is the retail division of Garden Games Ltd.

The logo to look out for...

There are many more products we have created - just look out for our Big Game Hunters logo or flower emblem to be sure you have an official product.

Our brand is not just a logo, it is the whole family of ideas, service and quality that are behind every product. We are not a huge corporate and do not claim to be - we are proud of who we are and what we create. So look out for our brand knowing that each product carrying our logo has a special standard we aim to maintain for years and years to come...



Bee-Ball®

is exclusive to

Big Game Hunters:

+441865 392439

sales@biggamehunters.co.uk

biggamehunters.co.uk

@thePlayExperts

Please retain for future reference