

Big Game
hunters



Sandpits



Hexagonal Sandpit
Instructions



Screwdriver

Tools Required
 Benötigtes Material / Accessoires / Herramientas
 Strumenti da lavoro / Benodigdheden

Adult Assembly Required

Parts Included

Unterteile / Liste des pièces / Lista de partes
 Elenco degli elementi / Onderdelen

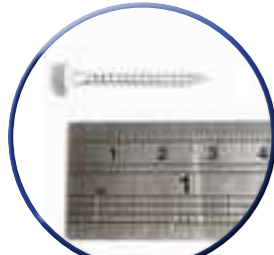

Screw A - 30mm
(48 x)

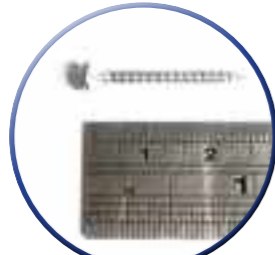

Screw B - 25mm
(12 x)

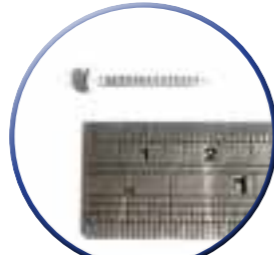

Screw C - 20mm
(12 x)

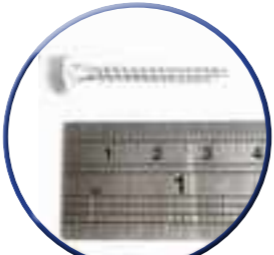

Screw D - 35mm
(24 x)

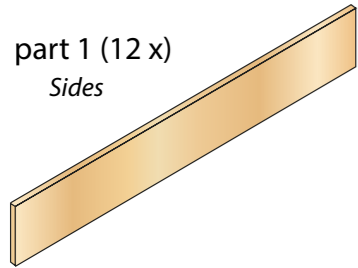

part 1 (12 x)
Sides

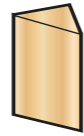

part 2 (6 x)
Corner Posts

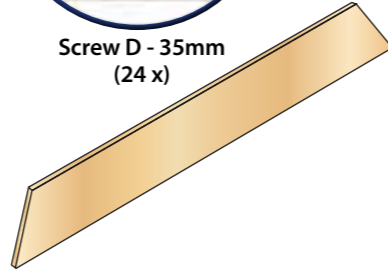

part 3 (6 x)
Top Edges



part 4 (6 x)
Side Batons

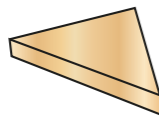

part 5 (6 x)
Corner Triangles



part 6
Underlay



part 7
Weather
Cover

Remember...

We strongly recommend looking after these instructions, after all without them it will be a bit tricky to put this product together. Even though we know our customers are more intelligent than most, we still think you may find these instructions useful.
But if something unexpected were to happen, such as,

Your dog ate them...



or your children constructed a kite out of them?



or your neighbour ran over them in their car?



You would have nothing to fear because we have uploaded all of our instructions to our website:
www.biggamehunters.co.uk

1

Building the Sides of the Sandpit

You will need:

- 12 x Parts 1 (Sides)
- 6 x Parts 2 (Corner Posts)
- 48 x Screws 'A' (30mm)

Place one corner post upright, and attach two Parts 1 (sides) using four Screws 'A'. - one above the other (see diagram 1).

Screw in another part 1 to the corner post using another two Screws 'A' to form one corner of the sandpit - then attach another above it as shown in the diagram 1a below.

Continue this using all six corner posts to create all six sides of the hexagon.

You do not need to tighten the screws all the way in at this stage, just screw them in enough to form and hold the structure of the sandpit.

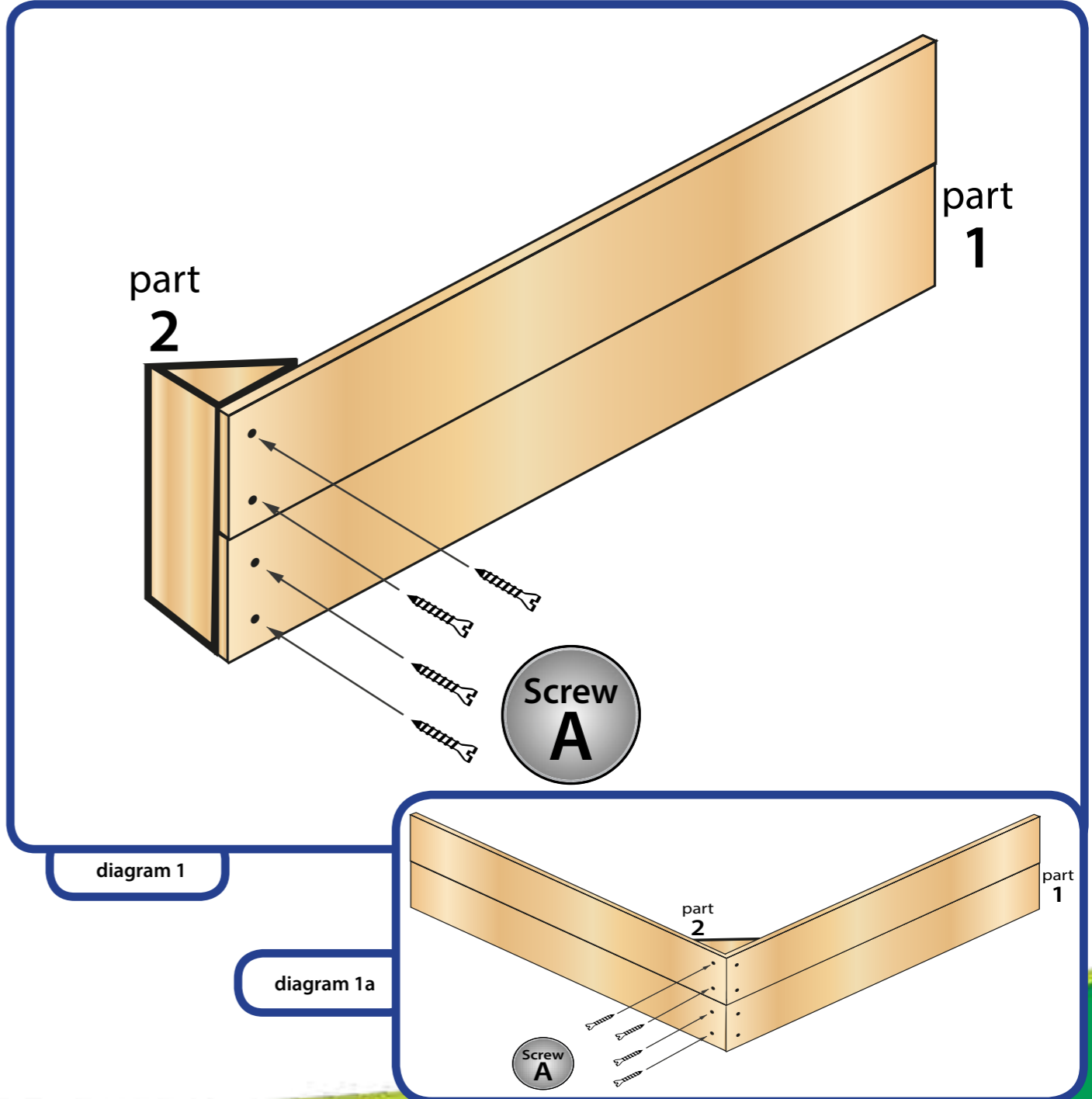

diagram 1

diagram 1a

2**Build the Seats of the Sandpit**

You will need:
 6 x Parts 3 (Top Edges)
 24 x Screws 'D' (35mm)

Lay all the top edges (parts 3) out flat on the top on the hexagonal sandpit frame. The edges of these should meet in the middle of the corner posts. Make sure these are properly lined up to form the hexagon before screwing them down.

Fix these in place using Screws 'D' and the guide holes provided (two at the end of each panel).

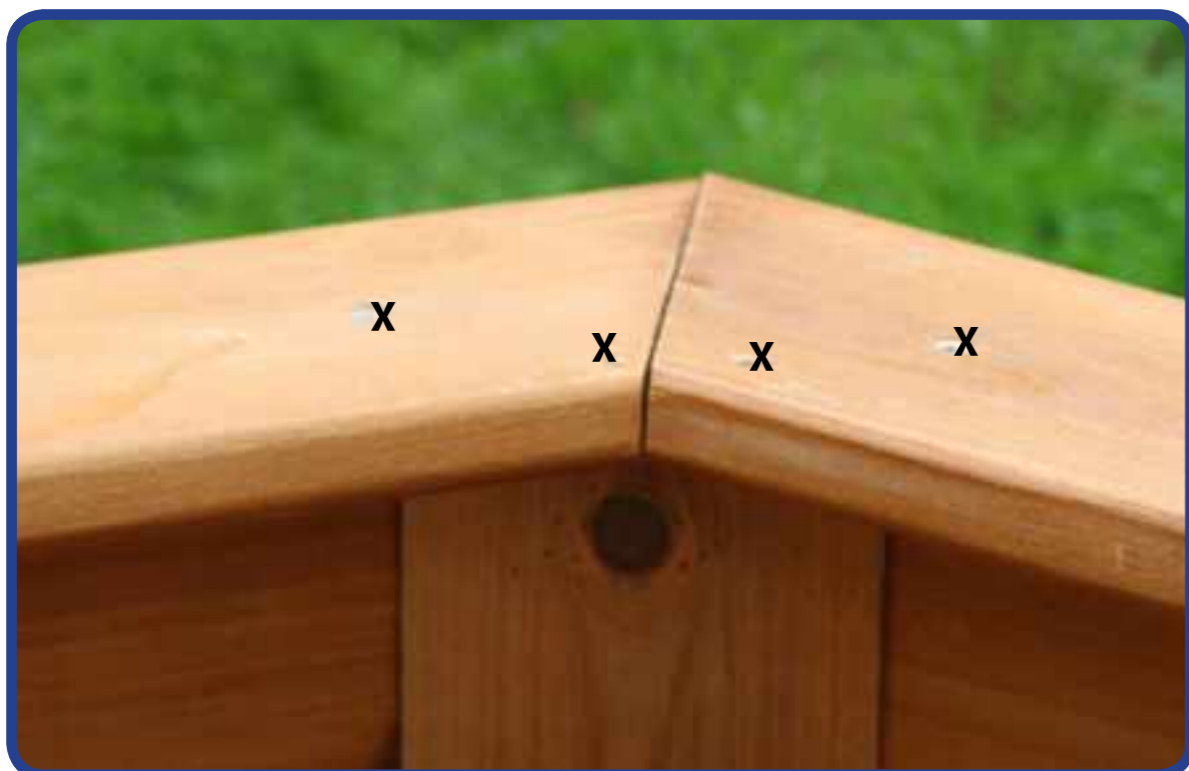
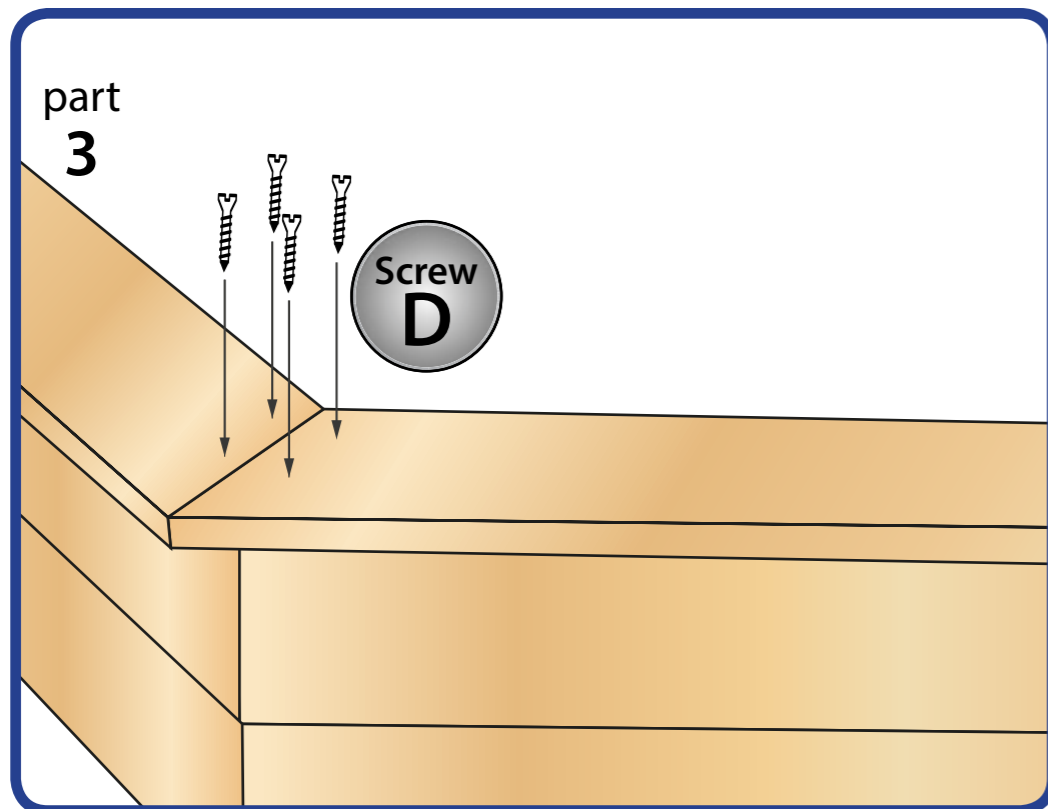
**3****Securing the Corners**

You will need:
 6 x Parts 5 (Corner Triangles)
 12 x Screws 'B' (25mm)

Reinforce the corners of the sandpit using six parts 5 (Corner Triangles) and twelve Screws 'B'. Screw them to the underside of each corner where the two part 3's meet using the 25mm screws.

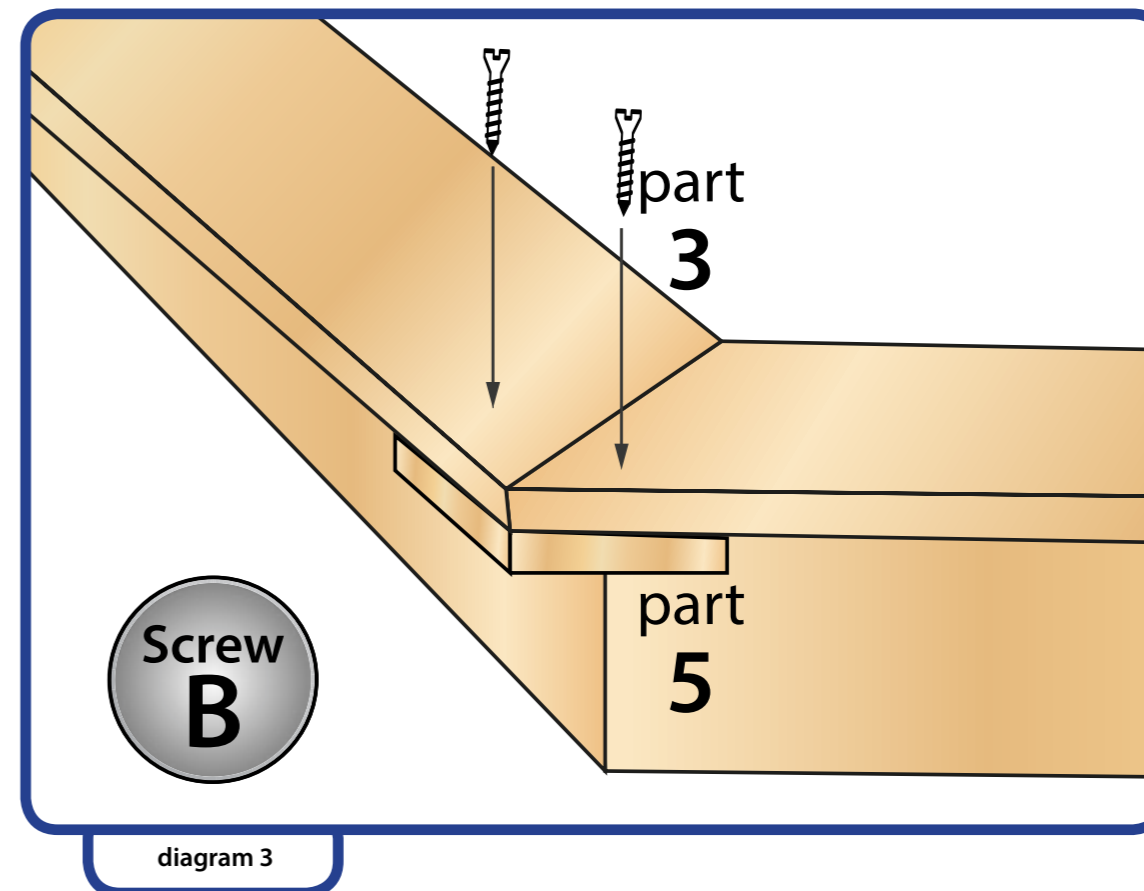
**4****Adding the Underlay**

You will need:
 Part 6 (Underlay)
 6 x Parts 4 (Side Batons)
 12 x Screws 'C' (20mm)

Fix the sandpit underlay in place using the six Side Batons (parts 4) and twelve Screws 'C' (20mm).

You do this by laying the underlay inside the sandpit and screwing the batons (parts 4) to the inside of the sandpit with the underlay in between (see diagram 4).

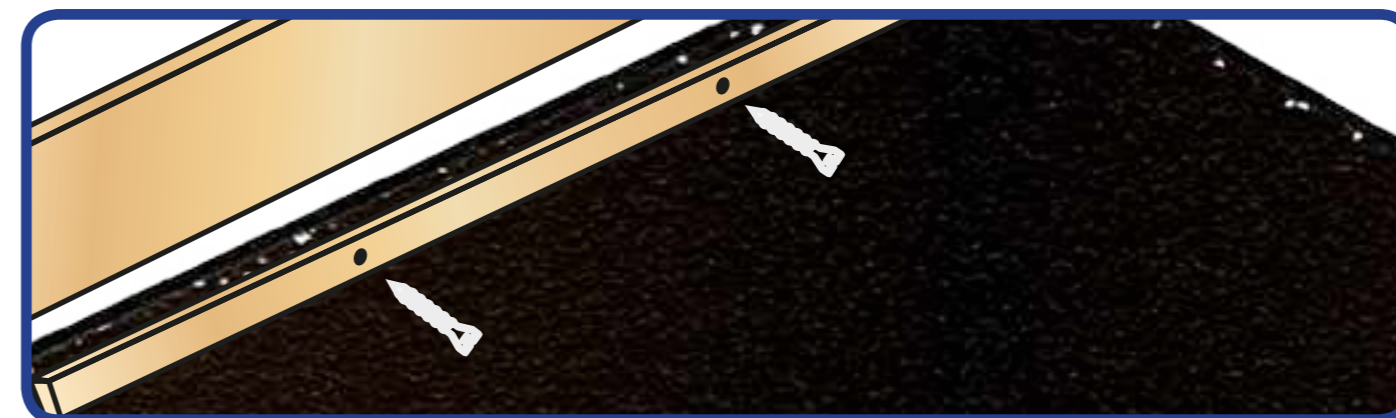

diagram 4

The Finale

Now your sandpit is complete, you simply need to decide where you are going to place it. The sandpit should be placed on a suitable ground surface such as grass or a play mat.

We would now recommend you go round all the screws to make sure they are all tight as they can loosen slightly when you move the sandpit. Fill the sandpit with sand and it is now ready to use.

We recommend filling the sandpit with 6 to 8 x 25kg bags of play sand. It is important to use play sand as this is non-abrasive and other types of sand can hurt little hands.



When the sandpit is not being used...

Don't forget to put the showerproof cover on when the sandpit is not being used. The cover will help to protect it and keep it looking good. There is a wooden cover for this sandpit which is available for purchase separately. An item with a height greater than the sandpit can be placed in the centre of the sandpit before the cover is placed on top. This will prop up the cover and allow water to run off and prevent "puddling". Should water accumulate and form a pool, please ensure this water is removed regularly as the water can pose a danger to children.

If your sand gets particularly wet, make sure you take the cover off on the first sunny day in Spring and allow your sand to dry out. You may want to replenish the play sand in your sandpit every year as it can get dirty and often gets thrown out through enthusiastic play! Placing the rain cover on after every use will help keep leaves, debris and cheeky little animals out of the sand!



Wooden Cover*

*available for purchase separately

Inspection & Maintenance

We recommend the following inspection and maintenance.



Looking After Your Sandpit

Your Hexagonal Sandpit is made of good quality fir wood. It has been treated to keep it looking good in your garden and to protect it from the elements. Despite this it should be covered in severe weather conditions. We recommend re-treating your sandpit regularly to prolong its life and keep it looking good too.

We would recommend a non-toxic wood stain - preferably tested to meet EN71 safety regulations (these are European children's play equipment safety rules).

Avoid products which contain ANY of the following:

antimony, arsenic, barium, cadmium, chromium, lead, mercury and selenium.

Wood is Natural - so we accept its quirks, naturally!

There will be a reason you have bought a wooden sandpit and not a plastic one. Like us, you are likely to appreciate the beauty and quality that a wooden product can give. They are also a little kinder on the environment than plastic products. As with all wooden products, some variation in colour may be apparent and the wood will expand and shrink in wet and dry conditions. As a result of this natural expanding and contracting some cracks and splits may occur which is normal and nothing to worry about - it just shows it is a natural product.

So please accept these quirks, and look after it - it deserves your care and attention!

Weekly to monthly / routine visual inspection

Check wood for splinters which may occur - these could hurt little hands or become a choking hazard.

Check for loose screws and fixings and tighten where and when necessary.

1 - 3 Months / operational inspection

Check the stability of the construction

1 - 2 times per year / annual inspection

Check for rust and corrosion of bolts and screws and replace where necessary.

Warnings!

 **For family domestic use only. Intended for outdoor use by children aged 18 months+. Cover not suitable for children under 3 years because of small parts which could be a choking hazard. To be used under the supervision of an adult. Install the product in a way to avoid risk of entrapment - with sufficient gap between the product and other surfaces.**

 **Warnung! Nur für den häuslichen Gebrauch. Für Kinder unter 3 Jahren / 36 Monaten der Deckel ist nicht geeignet, wegen verschluckbare Kleinteile. Durch verschluckbare Kleinteile besteht Erstickungsgefahr. Nur unter der direkten Aufsicht eines Erwachsenen benutzen. Bei der Montage des Produktes in ein Spielgerät oder eine andere Konstruktion muss sichergestellt werden, dass keine Fangstellen für Gliedmasse oder Kleidungsstücke entstehen.**

 **Attention! Exclusivement à usage familial. La couvercle es ne convient pas aux enfants de moins de 3 ans / 36 mois, présence de petits éléments susceptibles d'être ingérés ou inhalés - risque d'étouffement.. À utiliser sous la surveillance rapprochée d'un adulte. Au cas où l'on incorpore le produit dans un jeu ou une construction quelconque, il faudra le faire de façon à éliminer tout risque de coincage.**

 **¡Advertencia! Exclusivamente para uso doméstico. La cubierta no conveniente para menores de 3 años / 36 meses - partes pequeñas con riesgo de ingestión o inhalación - riesgo de atragantamiento.. Se utilizará exclusivamente bajo la vigilancia directa de una persona adulta. La instalación de este producto en un juego infantil o otra construcción debe estar hecho así que peligro para quedarse atascado quede excluido.**

 **Attenzione! Solo per uso domestico. Il coperchio non adatto ai bambini di età inferiore a 3 anni / 36 mesi - presenza di piccoli elementi suscettibili di ingestione o inalazione - pericolo di soffocamento.. Utilizzare sotto la sorveglianza diretta di un adulto. Effettuare il montaggio in modo che si eviti il rischio di intrappolamento.**

 **Waarschuwing! Alleen voor privé gebruik. De cover is niet geschikt voor kinderen jonger dan 3 jaar / 36 maanden wegens kleine elementen met het risico op inslikken of inademen - verstikkingsgevaar. Alleen voor privé gebruiken onder toezicht van een volwassene. Het inbouwen van dit product in een speeltoestel of andere constructie dient zodanig te gebeuren dat voor beknelling uitgesloten is.**

ARE YOU a PLAY EXPERT?

Take a photo and share it with us using #littleplayexpert or #bigplayexpert and be part of our growing network of play experts! Thousands of people every day are showing us that they are truly expert at play and playing in so many different ways - are you?



42 likes

@theplayexperts Literally jumping for joy! I think we are seriously #bigplayexpert s ! #nevertooold #foreveryoung



107 likes

@theplayexperts our niece and daughter enjoying a game at a family wedding. Never too young for chess!



94 likes

loving the hi tower challenge @theplayexperts - its harder than it looks! #bigplayexpert #littleplayexpert



51 likes

The concentration on their faces! #littleplayexpert @theplayexperts

Not Just Sandpits...

You may or may not be aware that we design and make many different kinds of garden games and play equipment.

Big Game Hunters has been designing and creating games for children and families since 1997 - so by now we really do know what we are doing.

Here are just a few that are great for the whole family as well as just the kids...

The Parachute Game



Mega Hi-Tower



Hardwood Boules



Wooden Skittles

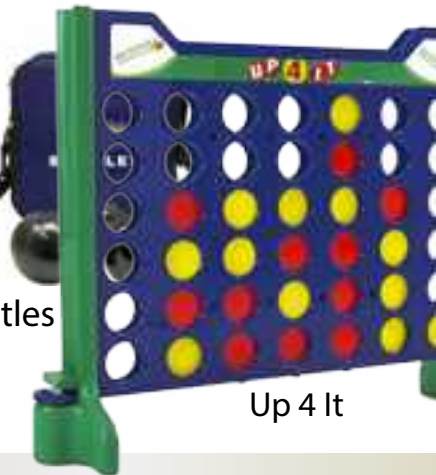

Up 4 It

The logo to look out for...

There are many more products we have created - just look out for our Big Game Hunters logo or flower emblem to be sure you have an official product. The brand is not just a logo, it is the whole family of ideas, service and quality that are behind every product. We are not a huge corporate and do not claim to be - we are proud of who we are and what we create so look out for our brand knowing that each product carrying our logo has a special standard we aim to maintain for years and years to come...



Random Factoid Bubbles

One of the very first times sand play was recorded was when giant piles of sand were heaped up in parks in Berlin in 1850.

They called these piles "sand bergs"!

CE Please retain for future reference

Garden Games Limited
Chadwick Farm • Garford
Oxfordshire • OX13 5PD • England

+441865 392439
sales@biggamehunters.co.uk
biggamehunters.co.uk
@theplayexperts

