

VEROBOARD®

LED Type: VBDFS-L2835-XXXX-120-24-WP
Colour: 3000K • 4000K

Job Name: _____

Distributor: _____

Type: _____

	Wattage	Brightness
Per Foot	3W/ft	298Lm/ft
Per Meter	10W/m	980Lm/m



666561429201



666561430146

DESCRIPTION

Flexible 14 mm wide linear LED strip. Available in 20 meter (65.6 feet) rolls that can be cut every 6 LEDs (50 mm or 2 in). The LED Strip lights are manufactured with high-quality materials and designed for professional lighting. Every strip light begins with a heavy-duty dual-core copper printed circuit board (PC Board), it is then soldered with an array of chips and color options. Moreover, the strip lights come with a strong 3M adhesive backing. They can be cut to any size (marked interval points) and rejoined by soldering.

DIMENSIONS

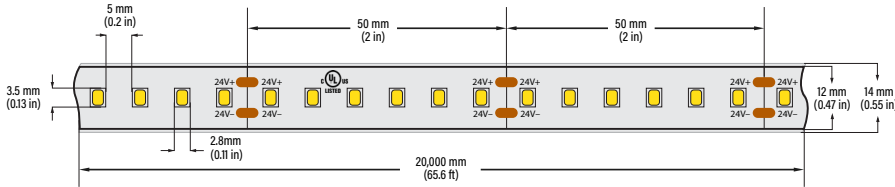

SPECIFICATIONS

Model:	VBDFS-L2835-XXXX-120-24-WP
Color Temperature:	3000K • 4000K
LED Type:	2835 SMD
LED Qty:	120 LEDs per meter
LM/LED:	8 Lm per LED
Input Voltage (VF):	24V DC
Power:	10W per meter (3W/ft)
Brightness:	980 Lm/meter (298 Lm/ft)
Lifespan:	>50,000 hours
PCB:	4oz PCB, Double-side, white colour
IP Rating:	IP68 (Waterproof)
Rendering Index (Ra):	CRI>95
Beam Angle:	120°
Dimmable:	Yes
Cut Size:	Every 6 LED chips (2")
Operating Temperature:	-15°C to +40°C
Dimensions:	20,000mm x 14mm x 5.8mm (787.2" x 0.55" x 0.22")
Certificates:	UL / RoHs
Roll Length:	20 meter roll (65.6ft)

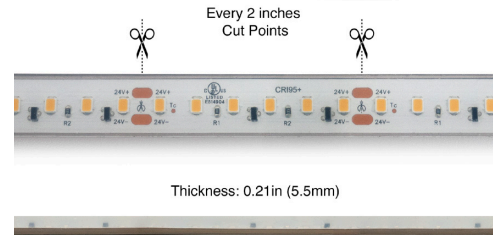
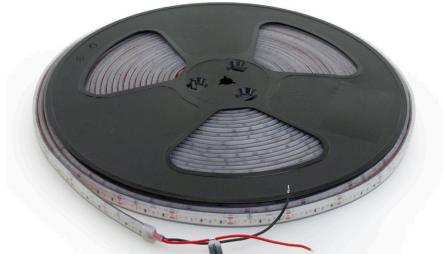

Accessories (Sold Separately)

Model: 3W-2C-SC
SKU: 666561406288

3 Way Outdoor
Screw Type Connector
2 Contact



Model: 2W-2C-SC
SKU: 666561406295

2 Way Outdoor
Screw Type Connector
2 Contact



Model: 3W-JB-M686
SKU: 666561434182



ORDERING GUIDE

Example part number: **VBDFS - L2835 - XXXX - 120 - 24 - WP**

MODEL	SERIES	COLOUR	LEDS/METER	VOLTAGE	LENGTH
VBDFS	L2835	XXXX 3000K 4000K	120	24V	XXXX Custom Length Full Roll (20 Meter)

For more information about our products and services, please visit our website: www.veroboard.com

Light Measurement Report

Print date: 2023-05-02

Measurement date and time: 2023-05-02 12:18:14 PM – Measurement no. VFR-230502-0196-MS

Luminous Intensity diagram

Unit: 0-100% of peak intensity

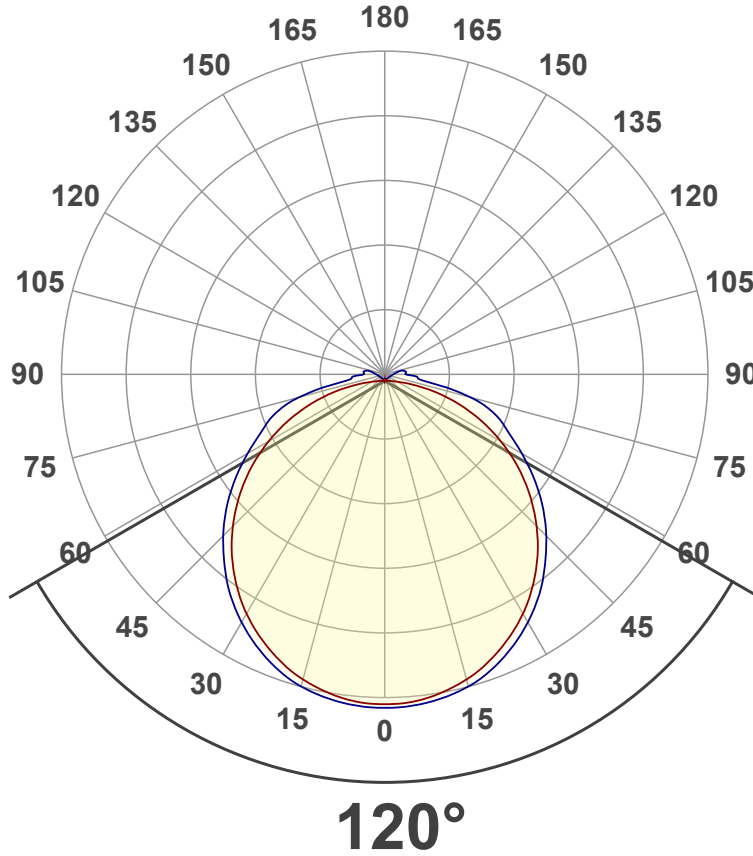

Main Values

Lumen Up% / Down%	4.93% / 95.07%
Peak Intensity	15.1 cd
Beam Angle (50%)	120°
Beam Angle (90%)	122.3°
Beam Angle (10%)	114.7°

Cut-off Angle

Average 2,5%	216.8°
--------------	--------

Field Angle

Average 10%	179.4°
-------------	--------

Intensity Ratio

In 120° cone	70.2%
In 90° cone	47.0%

C000-C180
C090-C270

Linear distribution diagram - Intensity (candela) vs γ-angle

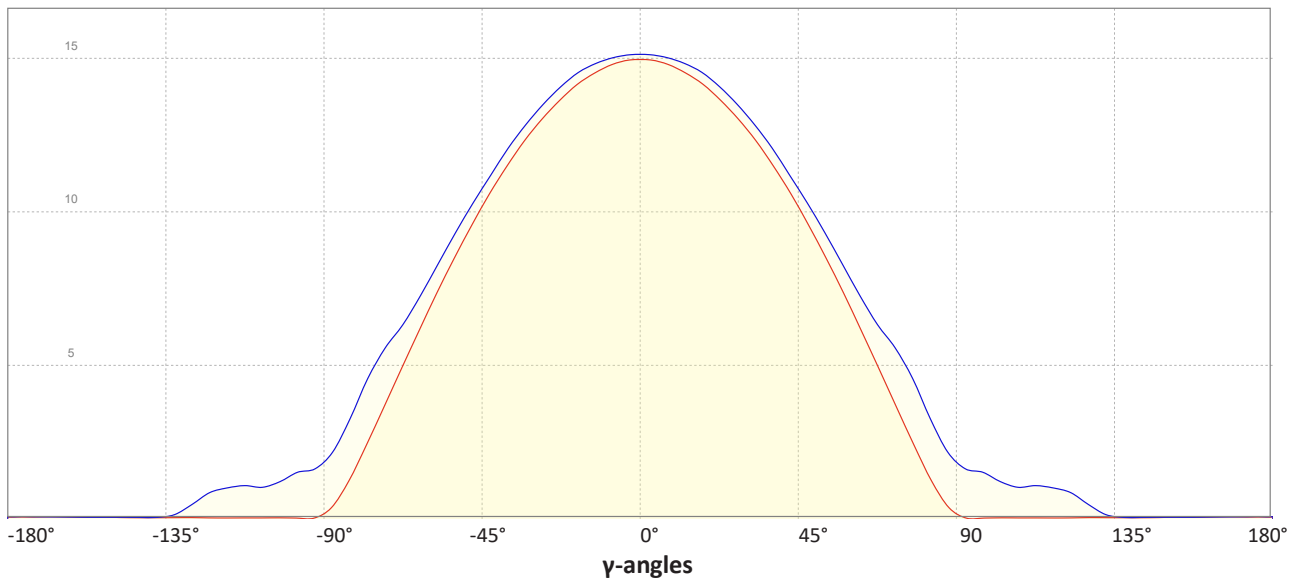

Light Measurement Report

Print date: 2023-05-02

Measurement date and time: 2023-05-02 12:18:14 PM – Measurement no. VFR-230502-0196-MS

Color details

Correlated Color Temperature, Target CCT = 3000 K
 Correlated Color Temperature, Measured CCT = 3043 K
 Color Rendering Index CRI 96.4
 Color Rendering Index, R9 (red component) R9 = 90.7
 Color Rendering TM30-18 R_f 93.6 – R_g 97.4
 Color Quality Scale CQS = 90.2

MacAdam Steps
 Color coordinates CIE 1931 (x;y) = (0.437;0.404)
 Color coordinate CIEs 1960 (u;v) = (0.251;0.348)
 Color deviation from BBL Duv = 0.0070
 Color coordinate CIEs 1976 (CIELUV) (u';v') = (0.251;0.251)

CIE 1931



CIE 1931 – zoomed on Planckian locus

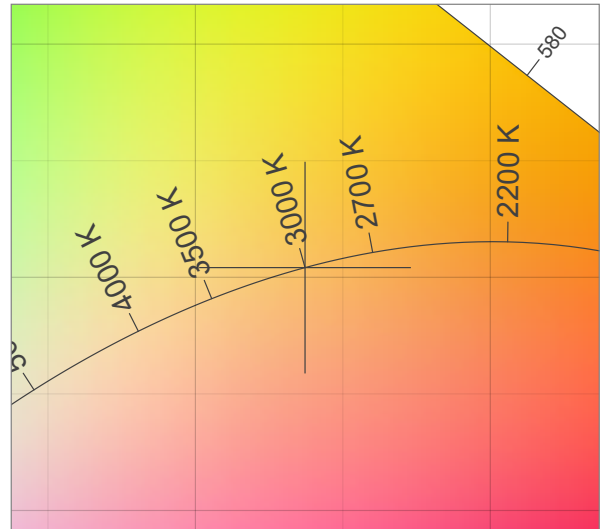

Color Rendering Index per reference color (CIE 1995)

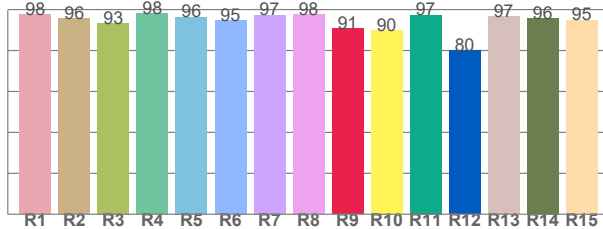

CRI R values, only R1-R8 are used to calculate final CRI value

R1	R2	R3	R4	R5	R6	R7	R8	R9	R10	R11	R12	R13	R14	R15
97.6	95.5	93.4	98.0	96.4	94.8	97.4	97.7	90.7	89.9	97.5	80.0	96.5	95.8	94.9

Spectral power distribution (SPD) / W/nm – 0-100%

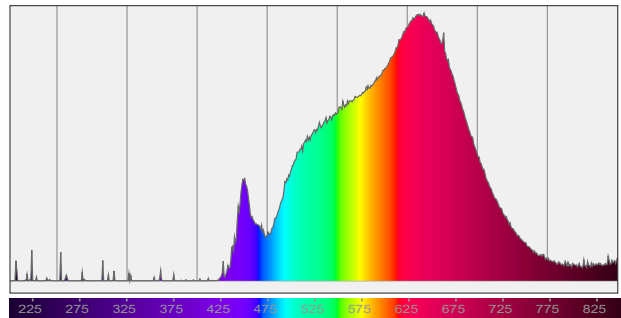

TM30-18 R_f-values per hue bin

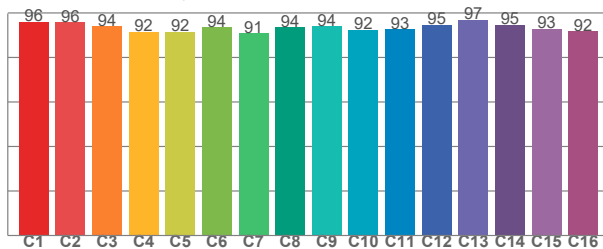

TM30 C values, 16 binned values out of total of 99 C values

C1	C2	C3	C4	C5	C6	C7	C8	C9	C10	C11	C12	C13	C14	C15	C16
96.1	95.8	94.0	91.7	91.6	93.6	90.8	93.6	94.0	92.4	92.6	94.7	97.0	94.6	92.9	91.7

Color Quality Scale by reference color

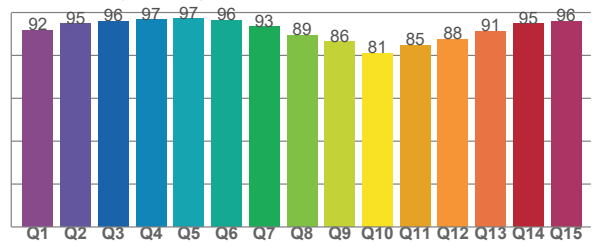

CQS Q values

Q1	Q2	Q3	Q4	Q5	Q6	Q7	Q8	Q9	Q10	Q11	Q12	Q13	Q14	Q15
91.8	94.8	95.9	96.6	97.1	96.4	93.4	89.2	86.3	81.1	84.7	87.6	91.4	94.7	96.0

Light Measurement Report

Print date: 2023-05-02

Measurement date and time: 2023-05-02 12:18:14 PM – Measurement no. VFR-230502-0196-MS

Beam Details

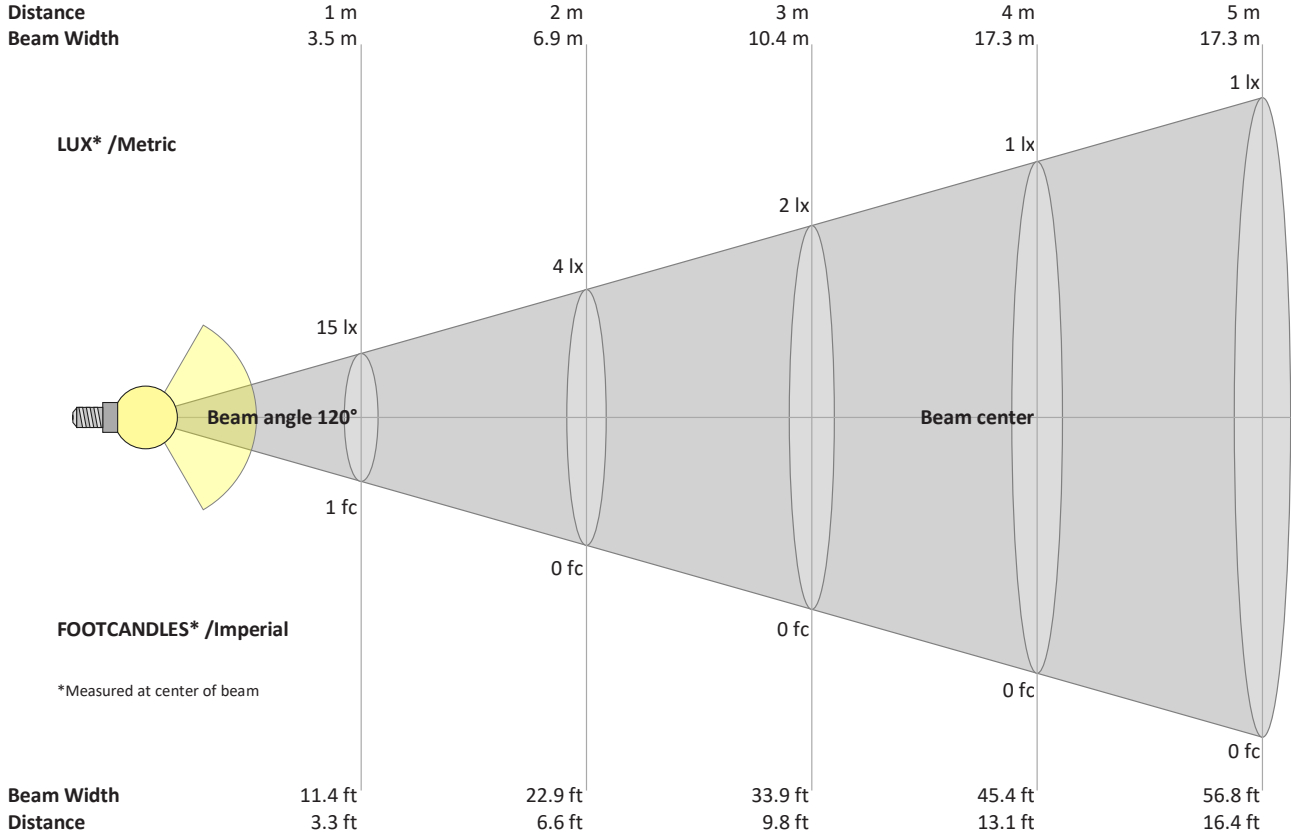

Beam intensities from 1 – 20 m

1	2	3	4	5	6	7	8	9	10	11	12	13	14	15	16	17	18	19	20	m	
3.3	6.6	9.8	13.1	16.4	19.7	23	26.2	29.5	32.8	36.1	39.4	42.7	45.9	49.2	52.5	55.8	59.1	62.3	65.6	ft	
15	4	2	1	1	0	0	0	0	0	0	0	0	0	0	0	0	0	0	0	0	lux
1.4	0.3	0.2	0.1	0.1	0	0	0	0	0	0	0	0	0	0	0	0	0	0	0	0	fc

Intensities in 0° c-plane

0°	5°	10°	15°	20°	25°	30°	35°	40°	45°	50°	55°	60°	65°	70°	75°	80°	85°	90°	95°	y	
15.0	14.9	14.7	14.4	13.9	13.4	12.7	12.0	11.1	10.2	9.1	8.0	6.8	5.6	4.4	3.1	1.9	0.9	0.2	0.0	0.0	cd
100%	99%	98%	96%	93%	89%	85%	80%	74%	68%	61%	53%	46%	37%	29%	21%	13%	6%	1%	0%	0%	of 0°val

Intensities in 90° c-plane

0°	5°	10°	15°	20°	25°	30°	35°	40°	45°	50°	55°	60°	65°	70°	75°	80°	85°	90°	95°	y	
15.0	15.1	14.9	14.7	14.3	13.8	13.2	12.5	11.6	10.7	9.8	8.8	7.8	6.8	6.0	5.1	3.9	2.7	1.9	1.6	1.6	cd
100%	100%	99%	98%	95%	92%	88%	83%	77%	72%	65%	59%	52%	45%	40%	34%	26%	18%	13%	10%	10%	of 0°val

Intensities in 180° c-plane

0°	5°	10°	15°	20°	25°	30°	35°	40°	45°	50°	55°	60°	65°	70°	75°	80°	85°	90°	95°	y	
15.0	14.9	14.7	14.4	13.9	13.4	12.7	12.0	11.1	10.2	9.1	8.0	6.8	5.6	4.4	3.1	1.9	0.9	0.2	0.0	0.0	cd
100%	99%	98%	96%	93%	89%	85%	80%	74%	68%	61%	53%	46%	37%	29%	21%	13%	6%	1%	0%	0%	of 0°val

Intensities in 270° c-plane

0°	5°	10°	15°	20°	25°	30°	35°	40°	45°	50°	55°	60°	65°	70°	75°	80°	85°	90°	95°	y	
15.0	15.1	14.9	14.7	14.3	13.8	13.2	12.5	11.6	10.7	9.8	8.8	7.8	6.8	6.0	5.1	3.9	2.7	1.9	1.6	1.6	cd
100%	100%	99%	98%	95%	92%	88%	83%	77%	72%	65%	59%	52%	45%	40%	34%	26%	18%	13%	10%	10%	of 0°val

CUSTOM ORDERING GUIDE

Single Run (Straight Run): The below ordering guide will be used for single run LED strip.

- **PFL:** Power Feed Length
- **SL:** Strip Length

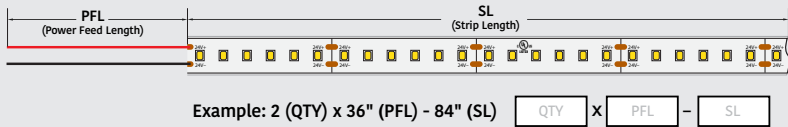

CUSTOM ORDERING GUIDE

Joiner: LED strip lights need joiners if they are used for curve applications such as corner side, behind a mirror, etc.

- **PFL:** Power Feed Length
- **SL:** Strip Length
- **JL:** Joiner Length

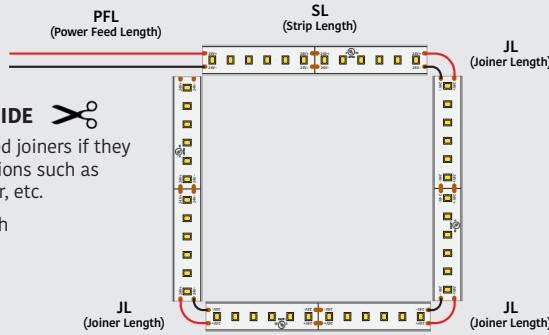

x - - - - - - -

Example: 1 (QTY) x 12" (PFL) - 46" (SL) - 1" (JL) - 36" (SL) - 1" (JL) - 46" (SL) - 1" (JL) - 36" (SL)

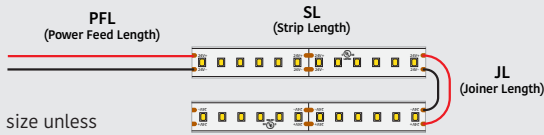

Note: Joiners will be 1-inch size unless customers require a specific size.

x - - -

Example: 2 (QTY) x 24" (PFL) - 52" (SL) - 1" (JL) - 52" (SL)

RECOMMENDED LED ALUMINUM CHANNELS

(Sold Separately)

VBD-CH-S6 10.60mm 20.15mm 23.44mm	VBD-CH-C2 18.5mm 1.4mm 18.5mm	VBD-CH-C2B 18.5mm 1.4mm 18.5mm
SKU: 666561423315	SKU: 666561423506	SKU: 666561423513
VBD-CH-RF4 23.4mm 18.6mm 27.96mm	VBD-CH-C1 23.68mm 15.07mm 21.19mm	VBD-CH-C3 30mm 20mm 20mm 30mm
SKU: 666561423377	SKU: 666561423490	SKU: 666561423520
VBD-CH-C3B 30mm 20mm 20mm 30mm	VBD-CH-C4 30mm 30mm 30mm	VBD-CH-C4B 30mm 30mm 30mm
SKU: 666561423537	SKU: 666561423544	SKU: 666561423551
VBD-CH-WC1 35.32mm 32.42mm 31.40mm 41.69mm	VBD-CH-RF3 20mm 17mm 27mm	VBD-CH-RF5 32mm 30.84mm 35.85mm 34.79mm
SKU: 666561423599	SKU: 666561423360	SKU: 666561423384
VBD-CH-R2 25.95mm 22.94mm 17.46mm 21.84mm	VBD-CH-R2B 25.95mm 22.94mm 17.46mm 21.84mm	VBD-CH-WC2 27.83mm 19mm 19mm 30.90mm
SKU: 666561423742	SKU: 666561428280	SKU: 666561423605

VBD-CH-WC3 42mm 32mm 32.46mm 31.84mm 35mm	VBD-CH-WC4 85mm 45.50mm 28.72mm 57.68mm 14.67mm 32.28mm 37.85mm	VBD-CH-RF6 31.90mm 46.42mm 23.80mm 50.20mm	VBD-CH-RF7 75mm 32.18mm 58mm 25.50mm 71mm 90mm
SKU: 666561423612	SKU: 666561423629	SKU: 666561423391	SKU: 666561423407
VBD-CH-RF8 32mm 23.50mm 70.15mm 75mm	VBD-CH-S1 50.21mm 40.80mm 43.34mm 50.88mm	VBD-CH-R3 38.40mm 56mm 60mm	VBD-CH-RF10 50.10mm 31.76mm 45.06mm 70mm 25mm
SKU: 666561423414	SKU: 666561423247	SKU: 666561423759	SKU: 666561423438
			VBD-CH-R1 26.78mm 20.72mm 16.70mm 19.30mm
			SKU: 666561423735

For more information about our products and services, please visit our website: www.veroboard.com

VBD-CH-D1	VBD-CH-D5	VBD-CH-D8	VBD-CH-D9
SKU: 666561423643	SKU: 666561423681	SKU: 666561423711	SKU: 666561423728

Note: To avoid a dark spot on the sides of these channels (RF10, RF6, RF8, R3, S1, R3) we recommend installing more than one Run LED Strip. For more details please contact us at: sales@veroboard.com

RECOMMENDED LED POWER SUPPLIES (Sold Separately)

For more options and varieties, please visit our website: www.veroboard.com

Constant Voltage Dimmable LED Drivers (5 in 1), Triac/Phase, 0-10V, 1-10V, Potentiometer, 10V PWM 5 in 1 Dimming



Model No.	Input Voltage	Output Voltage	Wattage	IP Rating	Class	Max. Strip Length	SKU#
VBD-024-030C2DM5i1	100-277V	24V	30W	IP67	Class 2	8ft	666561426033
VBD-024-060C2DM5i1	100-277V	24V	60W	IP67	Class 2	16ft	666561426040
VBD-024-080C2DM5i1	100-277V	24V	80W	IP67	Class 2	21.3ft	666561426088
VBD-024-096C2DM5i1	100-277V	24V	96W	IP67	Class 2	25.6ft	666561426057
VBD-024-192C2DM5i1	100-277V	24V	192W (2x96W)	IP67	Class 2	51.2ft	666561426064
VBD-024-288C2DM5i1	100-277V	24V	288W (3x96W)	IP67	Class 2	76.8ft	666561426071

Constant Voltage Triac LED Drivers forward Phase, Magnetic Low Voltage & Triac Dimmers



Model No.	Input Voltage	Output Voltage	Wattage	IP Rating	Class	Max. Strip Length	SKU#
VBD-024-024DM	100-130V	24V	24W	IP20	Class 2	6.4ft	666561415839
VBD-024-048DM	100-130V	24V	48W	IP20	Class 2	12.8ft	666561415822
VBD-024-060DM	100-130V	24V	60W	IP20	Class 2	16ft	666561415815
VBD-024-096DM	100-130V	24V	96W	IP67	Class 2	25.6ft	666561415808
VBD-024-150DM	100-130V	24V	150W	IP67	-	40ft	666561415792
VBD-024-200DM	100-130V	24V	200W	IP67	-	53.3ft	666561415785
VBD-024-300VTHWJ	100-277V	24V	300W	IP65	-	80ft	666561419806

DALI DIMMING CONSTANT VOLTAGE



Model No.	Input Voltage	Output Voltage	Wattage	IP Rating	Class	Max. Strip Length	SKU#
VBD-024-030DD	100-265V AC	24V	30W	IP20	Class 2	8ft	666561427306
VBD-024-060DD	100-265V AC	24V	60W	IP65	Class 2	16ft	666561427320
VBD-024-096DD	100-265V AC	24V	96W	IP65	Class 2	25.6ft	666561427344
VBD-024-150DD	100-265V AC	24V	150W	IP65	-----	40ft	666561427368
VBD-024-200DD	100-265V AC	24V	200W	IP65	-----	53.3ft	666561427375

PLUG-IN DRIVERS



Model No.	Input Voltage	Output Voltage	Wattage	IP Rating	Class	Max. Strip Length	SKU#
VBDA-024-024P1J	100-240V AC	24V	24W	IP20	Class 2	6.4ft	666561428969
VBDA-024-036P1J	100-240V AC	24V	36W	IP20	Class 2	9.6ft	666561428983
VBDA-024-060P1J	100-240V AC	24V	60W	IP20	Class 2	16ft	666561429003

Disclaimer:

The data and information contained in this specification sheet are subject to change without notice; the ratings supplied are provided based on the product manufacturer. The information contained in this specification sheet should not be considered a warranty, expressed or implied, including, but not limited to, a warranty of merchantability or fitness for a particular purpose. In no event shall Veroboard be liable for any incidental or consequential damages resulting from the use, misuse, or inability to use the product. This exclusion applies regardless of whether such damages are sought based on breach of warranty, breach of contract, negligence, strict liability in tort, or any other legal theory.

For more information about our products and services, please visit our website: www.veroboard.com