

# VEROBOARD®

**LED Type:** VBDFS-L2835-XXXX-120-24-NS  
**Colour:** 2700K • 3000K • 3500K • 4000K • 5000K • 6000K

**Job Name:** \_\_\_\_\_

**Distributor:** \_\_\_\_\_

**Type:** \_\_\_\_\_

	Wattage	Brightness
Per Foot	3W/ft	298Lm/ft
Per Meter	10W/m	980Lm/m



## DESCRIPTION

Flexible 12 mm wide linear LED strip. Available in 20 meter (65.6 feet) rolls that can be cut every 6 LEDs (50.8 mm or 2 in). The LED Strip lights are manufactured with high-quality materials and designed for professional lighting. Every strip light begins with a heavy-duty dual-core copper printed circuit board (PC Board), it is then soldered with an array of chips and color options. Moreover, the strip lights come with a strong 3M adhesive backing. They can be cut to any size (marked interval points) and rejoined by soldering.

## DIMENSIONS

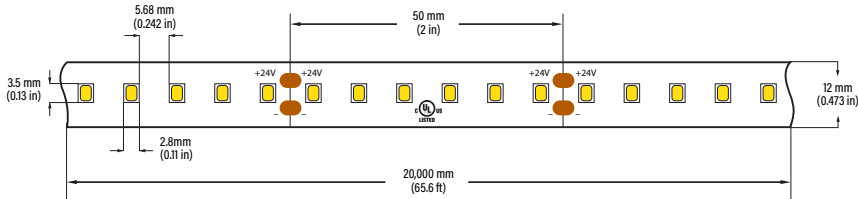

## SPECIFICATIONS

<b>Model:</b>	VBDFS-L2835-xxxx-120-24-NS
<b>Color Temperature:</b>	2700K • 3000K • 3500K • 4000K • 5000K • 6000K
<b>LED Type:</b>	2835 SMD
<b>LED Qty:</b>	120 LEDs per meter
<b>LM/LED:</b>	8-10 Lm per LED
<b>Input Voltage (VF):</b>	24V DC
<b>Power:</b>	10W per meter (3W/ft)
<b>Brightness:</b>	980 Lm/meter (298 Lm/ft)
<b>Lifespan:</b>	>50,000 hours
<b>PCB:</b>	4oz PCB, Double-side, white colour 12mm width
<b>IP Rating:</b>	IP20 (Indoor use only)
<b>Rendering Index (Ra):</b>	CRI>95
<b>Beam Angle:</b>	120°
<b>Dimmable:</b>	Yes
<b>Cut Size:</b>	Every 6 LED chips (2")
<b>Operating Temperature:</b>	-15°C to +40°C
<b>Dimensions:</b>	20,000mm x 12mm x 1.5mm (787.2" x 0.47" x 0.05")
<b>Certificates:</b>	UL / RoHS
<b>Roll Length:</b>	20 meter roll (65.6ft)



666561419653     666561419660     666561419677



666561419684     666561419691     666561419707

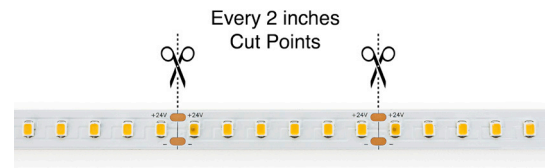
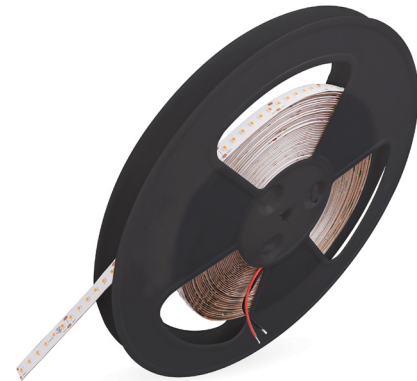

## ORDERING GUIDE

Example part number: **VBDFS - L2835 - XXXX - 120 - 24 - NS**

MODEL	SERIES	COLOUR	LEDS/METER	VOLTAGE	LENGTH
VBDFS	L2835	XXXX 2700K 4000K 3000K 5000K 3500K 6000K	120	24V	XXXX Custom Length Full Roll (20 Meter)



For more information about our products and services, please visit our website: [www.veroboard.com](http://www.veroboard.com)



# Light Measurement Report

Print date: 2023-05-02

Measurement date and time: 2023-05-02 11:22:03 AM – Measurement no. VFR-230502-0193-MS

## Luminous Intensity diagram

Unit: 0-100% of peak intensity

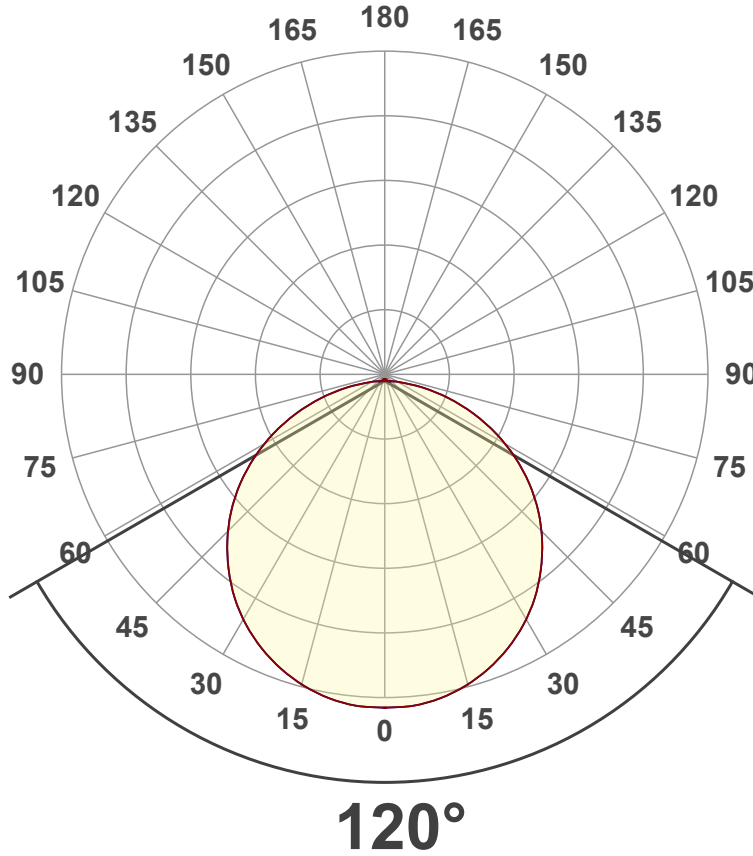

## Main Values

Lumen Up% / Down%	0.61% / 99.39%
Peak Intensity	18.8 cd
Beam Angle (50%)	120°
Beam Angle (90%)	116.1°
Beam Angle (10%)	116.1°

## Cut-off Angle

Average 2,5%	175.3°
--------------	--------

## Field Angle

Average 10%	163°
-------------	------

## Intensity Ratio

In 120° cone	77.4%
In 90° cone	52.1%

**C000-C180**  
**C090-C270**

## Linear distribution diagram - Intensity (candela) vs $\gamma$ -angle

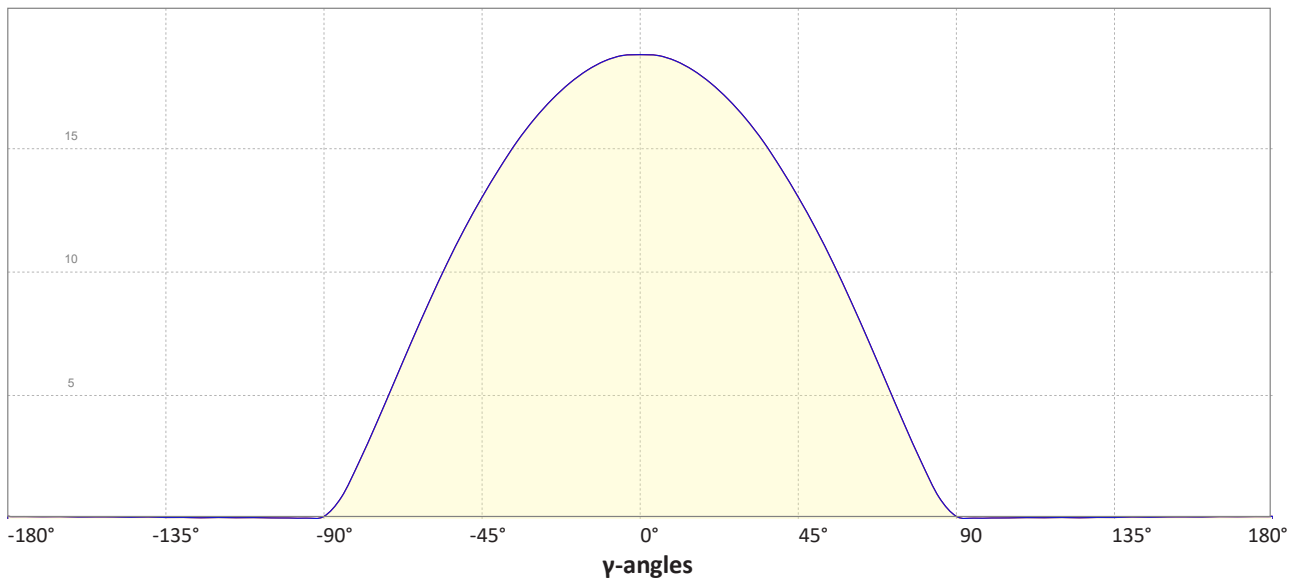

# Light Measurement Report

Print date: 2023-05-02

Measurement date and time: 2023-05-02 11:22:03 AM – Measurement no. VFR-230502-0193-MS

## Color details

Correlated Color Temperature, Target CCT = 3000 K  
 Correlated Color Temperature, Measured CCT = 3013 K  
 Color Rendering Index CRI 96.2  
 Color Rendering Index, R9 (red component) R9 = 94.0  
 Color Rendering TM30-18 R<sub>f</sub> 93.1 – R<sub>g</sub> 100.5  
 Color Quality Scale CQS = 95.4

MacAdam Steps  
 Color coordinates CIE 1931 (x;y) = (0.437;0.404)  
 Color coordinate CIEs 1960 (u';v') = (0.251;0.348)  
 Color deviation from BBL Duv = -0.0020  
 Color coordinate CIEs 1976 (CIELUV) (u'';v'') = (0.251;0.251)

CIE 1931

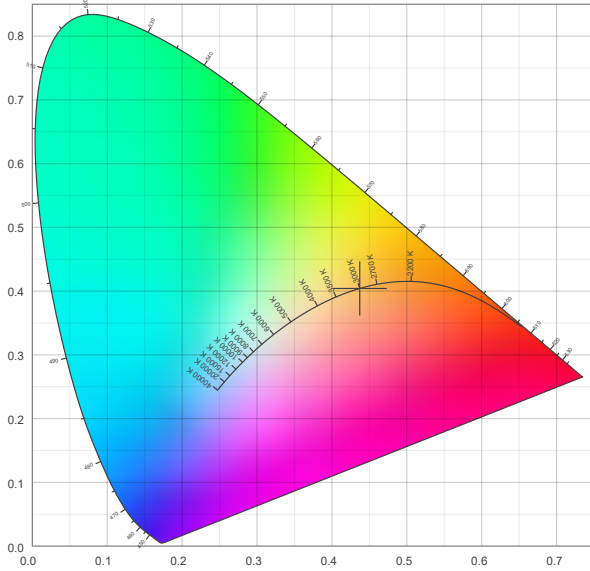

CIE 1931 – zoomed on Planckian locus

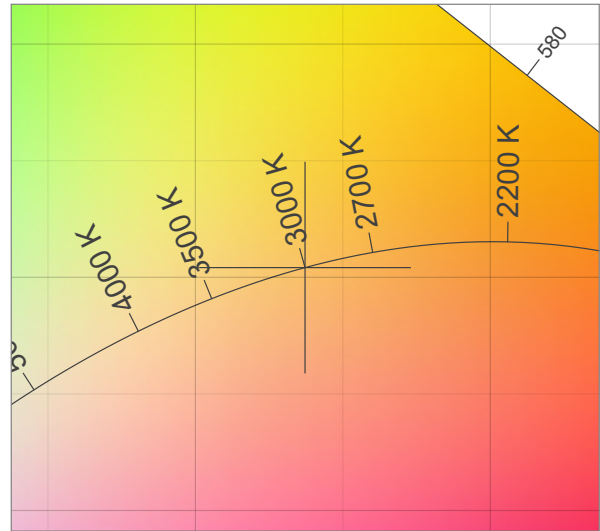

Color Rendering Index per reference color (CIE 1995)

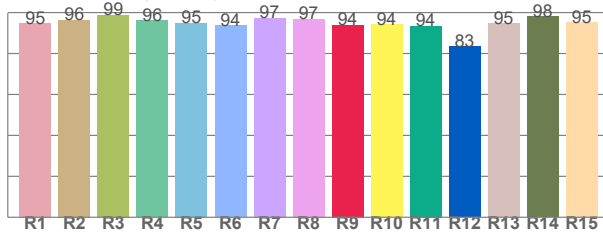

CRI R values, only R1-R8 are used to calculate final CRI value

R1	R2	R3	R4	R5	R6	R7	R8	R9	R10	R11	R12	R13	R14	R15
94.8	96.5	98.8	96.2	95.0	93.7	97.5	96.9	94.0	94.3	93.5	83.4	94.7	98.2	95.2

Spectral power distribution (SPD) / W/nm – 0-100%

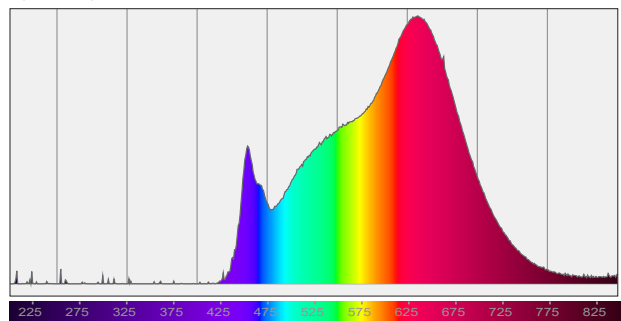

TM30-18 Rf-values per hue bin

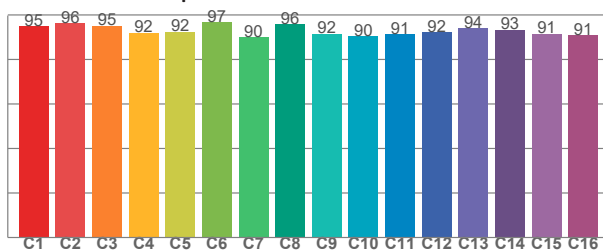

TM30 C values, 16 binned values out of total of 99 C values

C1	C2	C3	C4	C5	C6	C7	C8	C9	C10	C11	C12	C13	C14	C15	C16
94.9	96.2	95.1	91.9	92.5	96.7	90.0	95.8	91.6	90.5	91.3	92.2	94.0	93.3	91.4	90.9

Color Quality Scale by reference color

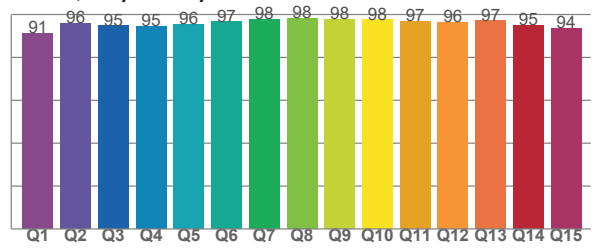

CQS Q values

Q1	Q2	Q3	Q4	Q5	Q6	Q7	Q8	Q9	Q10	Q11	Q12	Q13	Q14	Q15
91.3	96.0	94.7	94.6	95.5	96.6	97.8	98.2	97.8	97.5	96.9	96.4	97.1	95.1	93.6

# Light Measurement Report

Print date: 2023-05-02

Measurement date and time: 2023-05-02 11:22:03 AM – Measurement no. VFR-230502-0193-MS

## Beam Details

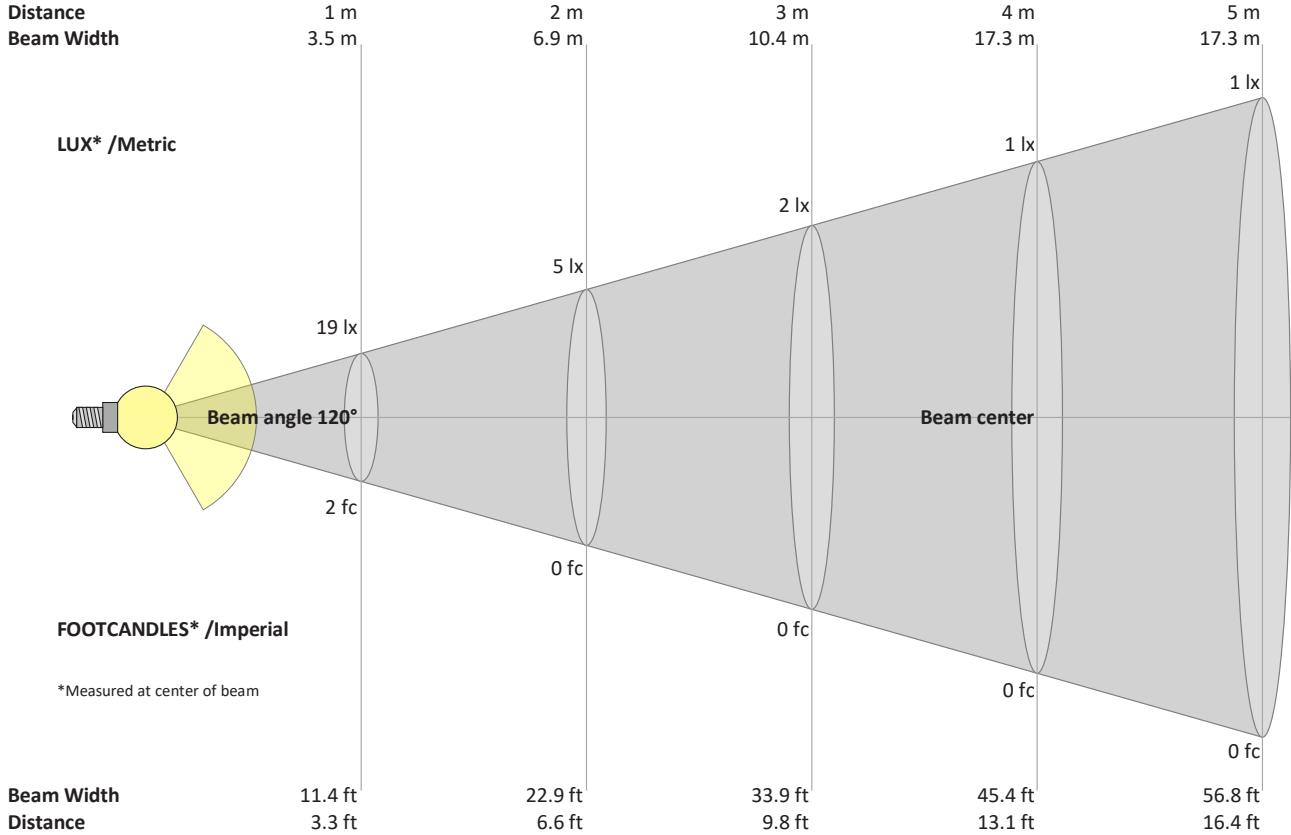

### Beam intensities from 1 – 20 m

1	2	3	4	5	6	7	8	9	10	11	12	13	14	15	16	17	18	19	20	m
3.3	6.6	9.8	13.1	16.4	19.7	23	26.2	29.5	32.8	36.1	39.4	42.7	45.9	49.2	52.5	55.8	59.1	62.3	65.6	ft
19	5	2	1	1	1	0	0	0	0	0	0	0	0	0	0	0	0	0	0	lux
1.7	0.4	0.2	0.1	0.1	0	0	0	0	0	0	0	0	0	0	0	0	0	0	0	fc

### Intensities in 0° c-plane

0°	5°	10°	15°	20°	25°	30°	35°	40°	45°	50°	55°	60°	65°	70°	75°	80°	85°	90°	95°	y
18.8	18.8	18.6	18.2	17.7	17.0	16.2	15.3	14.2	13.0	11.7	10.3	8.8	7.2	5.5	3.9	2.3	0.9	0.1	0.0	cd
100%	100%	99%	97%	94%	90%	86%	81%	76%	69%	62%	55%	47%	38%	29%	21%	12%	5%	1%	0%	of 0°val

### Intensities in 90° c-plane

0°	5°	10°	15°	20°	25°	30°	35°	40°	45°	50°	55°	60°	65°	70°	75°	80°	85°	90°	95°	y
18.8	18.8	18.6	18.2	17.7	17.0	16.2	15.3	14.2	13.0	11.7	10.3	8.8	7.2	5.5	3.9	2.3	0.9	0.1	0.0	cd
100%	100%	99%	97%	94%	90%	86%	81%	76%	69%	62%	55%	47%	38%	29%	21%	12%	5%	1%	0%	of 0°val

### Intensities in 180° c-plane

0°	5°	10°	15°	20°	25°	30°	35°	40°	45°	50°	55°	60°	65°	70°	75°	80°	85°	90°	95°	y
18.8	18.8	18.6	18.2	17.7	17.0	16.2	15.3	14.2	13.0	11.7	10.3	8.8	7.2	5.5	3.9	2.3	0.9	0.1	0.0	cd
100%	100%	99%	97%	94%	90%	86%	81%	76%	69%	62%	55%	47%	38%	29%	21%	12%	5%	1%	0%	of 0°val

### Intensities in 270° c-plane

0°	5°	10°	15°	20°	25°	30°	35°	40°	45°	50°	55°	60°	65°	70°	75°	80°	85°	90°	95°	y
18.8	18.8	18.6	18.2	17.7	17.0	16.2	15.3	14.2	13.0	11.7	10.3	8.8	7.2	5.5	3.9	2.3	0.9	0.1	0.0	cd
100%	100%	99%	97%	94%	90%	86%	81%	76%	69%	62%	55%	47%	38%	29%	21%	12%	5%	1%	0%	of 0°val

## CUSTOM ORDERING GUIDE ✂

**Single Run (Straight Run):** The below ordering guide will be used for single run LED strip.

- **PFL:** Power Feed Length
- **SL:** Strip Length



Example: 2 (QTY) x 36" (PFL) - 84" (SL)  x  -

## CUSTOM ORDERING GUIDE ✂

**Joiner:** LED strip lights need joiners if they are used for curve applications such as corner side, behind a mirror, etc.

- **PFL:** Power Feed Length
- **SL:** Strip Length
- **JL:** Joiner Length

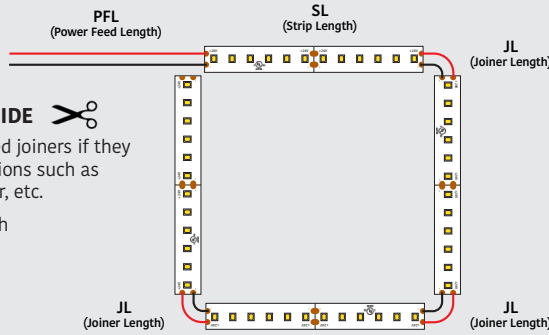

x  -  -  -  -  -  -  -

Example: 1 (QTY) x 12" (PFL) - 46" (SL) - 1" (JL) - 36" (SL) - 1" (JL) - 46" (SL) - 1" (JL) - 36" (SL)

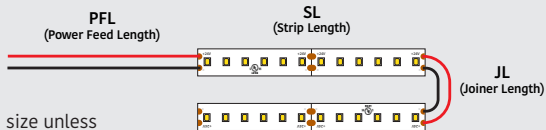

**Note:** Joiners will be 1-inch size unless customers require a specific size.

x  -  -  -

Example: 2 (QTY) x 24" (PFL) - 52" (SL) - 1" (JL) - 52" (SL)

## RECOMMENDED LED ALUMINUM CHANNELS

(Sold Separately)

<b>VBD-CH-S4</b>  15.5mm x 17.5mm x 12mm	<b>VBD-CH-S4B</b>  15.5mm x 17.5mm x 12mm	<b>VBD-CH-S6</b>  10.6mm x 23.44mm x 20.15mm
SKU: 666561423278	SKU: 666561423285	SKU: 666561423315
<b>VBD-CH-S5</b>  8mm x 17mm x 13mm	<b>VBD-CH-S5B</b>  8mm x 17mm x 13mm	<b>VBD-CH-B1</b>  6.14mm x 18.77mm x 13.89mm
SKU: 666561423292	SKU: 666561423308	SKU: 666561423360
<b>VBD-CH-C2</b>  18.5mm x 18.5mm x 14mm	<b>VBD-CH-C2B</b>  18.5mm x 18.5mm x 14mm	<b>VBD-CH-RF4</b>  23.4mm x 18.6mm x 18.6mm
SKU: 666561423506	SKU: 666561423513	SKU: 666561423377
<b>VBD-CH-RF1</b>  17mm x 15mm x 12.5mm	<b>VBD-CH-RF1B</b>  17mm x 15mm x 12.5mm	<b>VBD-CH-C1</b>  21.19mm x 25.68mm x 15.07mm
SKU: 666561423339	SKU: 666561423346	SKU: 666561423490
<b>VBD-CH-C3</b>  30mm x 30mm x 20mm	<b>VBD-CH-C3B</b>  30mm x 30mm x 20mm	<b>VBD-CH-W1</b>  21.43mm x 26.16mm x 12mm
SKU: 666561423520	SKU: 666561423537	SKU: 666561423445
<b>VBD-CH-RF7</b>  32.16mm x 75mm x 58mm	<b>VBD-CH-RF8</b>  32mm x 75mm x 23.50mm	<b>VBD-CH-S2</b>  9.88mm x 56.75mm x 17.29mm
SKU: 666561423407	SKU: 666561423414	SKU: 666561423254
<b>VBD-CH-WC4</b>  45.50mm x 85mm x 57.68mm	<b>VBD-CH-WC5</b>  39mm x 43.03mm x 53.84mm	<b>VBD-CH-ST2</b>  21mm x 95mm x 13mm
SKU: 666561423629	SKU: 666561423636	SKU: 666561423582
<b>VBD-CH-S3</b>  55.38mm x 13.56mm x 7.96mm	<b>VBD-CH-RF6</b>  31.90mm x 46.42mm x 23.80mm	<b>VBD-CH-RF5</b>  32mm x 34.79mm x 30.84mm
SKU: 666561423261	SKU: 666561423391	SKU: 666561423384
<b>VBD-CH-R2</b>  25.95mm x 21.84mm x 22.94mm	<b>VBD-CH-R2B</b>  25.95mm x 21.84mm x 22.94mm	<b>VBD-CH-D10</b>  136mm x 13.66mm x 12mm
SKU: 666561423742	SKU: 666561428280	SKU: 666561420023

For more information about our products and services, please visit our website: [www.veroboard.com](http://www.veroboard.com)

<b>VBD-CH-WC1</b>  SKU: 666561423599	<b>VBD-CH-WC2</b>  SKU: 666561423605	<b>VBD-CH-WC3</b>  SKU: 666561423612	<b>VBD-CH-S1</b>  SKU: 666561423247	<b>VBD-CH-R3</b>  SKU: 666561423759	<b>VBD-CH-RF10</b>  SKU: 666561423438
<b>VBD-CH-S55</b>  SKU: 666561429966	<b>VBD-CH-S55B</b>  SKU: 666561429973	<b>VBD-CH-C5</b>  SKU: 666561423568	<b>VBD-CH-R1</b>  SKU: 666561423735	<b>VBD-CH-D1</b>  SKU: 666561423643	<b>VBD-CH-D5</b>  SKU: 666561423681
<b>VBD-CH-RS5</b>  SKU: 666561428631	<b>VBD-CH-RS5B</b>  SKU: 666561428648	<b>VBD-CH-D7</b>  SKU: 666561423704	<b>VBD-CH-D8</b>  SKU: 666561423711	<b>VBD-CH-D9</b>  SKU: 666561423728	
<b>VBD-CH-M1</b>  SKU: 666561423773	<b>VBD-CH-M1B</b>  SKU: 666561431013	<b>VBD-CH-E1</b>  SKU: 666561423483			

**Note:** To avoid a dark spot on the sides of these channels (RF10, RF6, RF8, R3, S1, R3) we recommend installing more than one Run LED Strip. For more details please contact us at: [sales@veroboard.com](mailto:sales@veroboard.com)

## RECOMMENDED LED POWER SUPPLIES (Sold Separately)

For more options and varieties, please visit our website: [www.veroboard.com](http://www.veroboard.com)

### Constant Voltage Dimmable LED Drivers (5 in 1), Triac/Phase, 0-10V, 1-10V, Potentiometer, 10V PWM 5 in 1 Dimming



Model No.	Input Voltage	Output Voltage	Wattage	IP Rating	Class	Max. Strip Length	SKU#
VBD-024-030C2DM5i1	100-277V	24V	30W	IP67	Class 2	8ft	666561426033
VBD-024-060C2DM5i1	100-277V	24V	60W	IP67	Class 2	16ft	666561426040
VBD-024-080C2DM5i1	100-277V	24V	80W	IP67	Class 2	21.4ft	666561426088
VBD-024-096C2DM5i1	100-277V	24V	96W	IP67	Class 2	25.6ft	666561426057
VBD-024-192C2DM5i1	100-277V	24V	192W (2x96W)	IP67	Class 2	51.2ft	666561426064
VBD-024-288C2DM5i1	100-277V	24V	288W (3x96W)	IP67	Class 2	76.8ft	666561426071

### Constant Voltage Triac LED Drivers forward Phase, Magnetic Low Voltage & Triac Dimmers



Model No.	Input Voltage	Output Voltage	Wattage	IP Rating	Class	Max. Strip Length	SKU#
VBD-024-024DM	100-130V	24V	24W	IP20	Class 2	6.4ft	666561415839
VBD-024-048DM	100-130V	24V	48W	IP20	Class 2	12.8ft	666561415822
VBD-024-060DM	100-130V	24V	60W	IP20	Class 2	16ft	666561415815
VBD-024-096DM	100-130V	24V	96W	IP67	Class 2	25.6ft	666561415808
VBD-024-150DM	100-130V	24V	150W	IP67	-	40ft	666561415792
VBD-024-200DM	100-130V	24V	200W	IP67	-	53.3ft	666561415785
VBD-024-300VTHWJ	100-277V	24V	300W	IP65	-	80ft	666561419806

For more information about our products and services, please visit our website: [www.veroboard.com](http://www.veroboard.com)

