

# VEROBOARD®

**LED Type:** VBDFS-5050-RGB-60-12-NS  
**Colour:** RGB



## DESCRIPTION

Flexible 12 mm wide linear LED strip. Available in 5 meter (196.8 inches) rolls that can be cut every 3 LEDs (50.8 mm or 2 in). The LED Strip lights are manufactured with high-quality materials and designed for professional lighting. Every strip light begins with a heavy-duty dual-core copper printed circuit board (PC Board), it is then soldered with an array of chips and color options. They can be cut to any size (marked interval points) and rejoined by soldering.

## DIMENSIONS

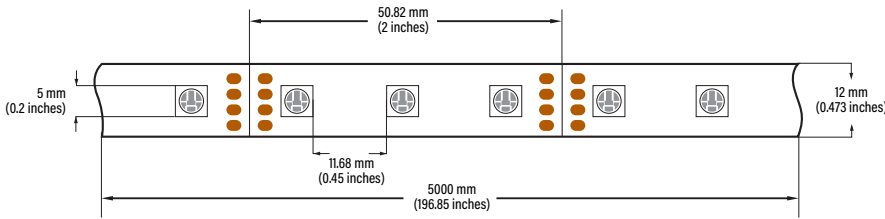

## SPECIFICATIONS

<b>Model:</b>	VBDFS-5050-RGB-60-12-NS
<b>Color Temperature:</b>	RGB
<b>LED Type:</b>	5050 SMD
<b>LED Qty:</b>	60 LEDs per meter
<b>Input Voltage (VF):</b>	12V DC
<b>Power:</b>	15W per meter (4.5W/ft)
<b>Brightness:</b>	2600-3000 MCD
<b>Lifespan:</b>	>50,000 hours
<b>PCB:</b>	4oz PCB, Double-side, white colour 12mm width
<b>IP Rating:</b>	IP20 (Indoor use only)
<b>Rendering Index (Ra):</b>	CRI>95
<b>Beam Angle:</b>	120°
<b>Dimmable:</b>	Yes
<b>Cut Size:</b>	Every 3 LED chips (2")
<b>Operating Temperature:</b>	-15°C to +40°C
<b>Dimensions:</b>	5,000 x 12 x 2.15mm (196.8" x 0.47" x 0.08")
<b>Certificates:</b>	UL / RoHs
<b>Roll Length:</b>	5 meter roll (16.4ft)

**Job Name:** \_\_\_\_\_

**Distributor:** \_\_\_\_\_

**Type:** \_\_\_\_\_

	Wattage
Per Foot	4.5W/ft
Per Meter	15W/m



666561409562

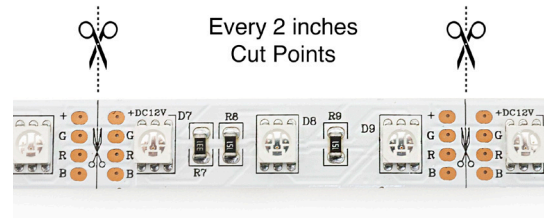

## ORDERING GUIDE

Example part number: **VBDFS - 5050 - RGB - 60 - 12 - NS**

MODEL	SERIES	COLOUR	LEDS/METER	VOLTAGE	LENGTH
VBDFS	5050	RGB	60	12V	XXXX

Custom Length  
Full Roll (5 Meter)

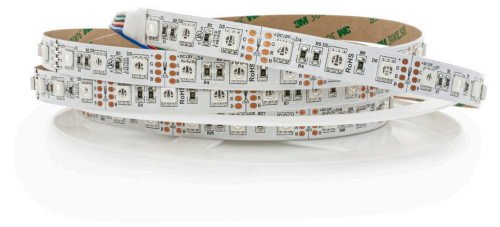

For more information about our products and services, please visit our website: [www.veroboard.com](http://www.veroboard.com)

## CONNECTORS (Sold Separately)

**Note:** Connectors fit in some aluminum channels only.

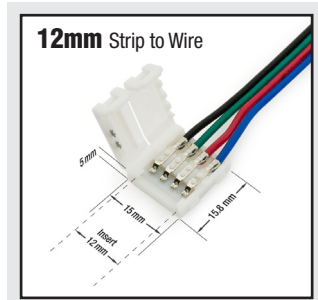

**MODEL:**

**VBD-RGBCON-12MM-1S1W**

**Material:** Plastic

**Strip Light Width:** 12mm

**Package Content:** LED Strip to Wire Connector (Pack of 1)

**Dimensions:** 15.8 x 15 x 5mm  
(0.62" x 0.59" x 0.19")

666561406967

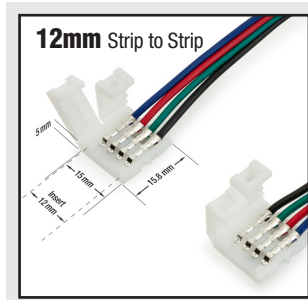

**MODEL:**

**VBD-RGBCON-12MM-CRNR**

**Material:** Plastic

**Strip Light Width:** 12mm

**Package Content:** LED Strip to Strip Connector (Pack of 1)

**Dimensions:** 15.8 x 15 x 5mm  
(0.62" x 0.59" x 0.19")

666561406776

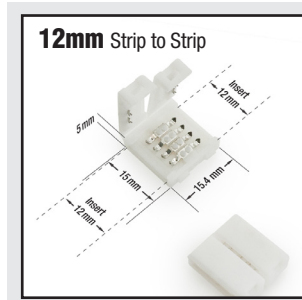

**MODEL:**

**VBD-RGBCON-12MM-2S**

**Material:** Plastic

**Strip Light Width:** 12mm

**Package Content:** LED Strip to Strip Connector (Pack of 1)

**Dimensions:** 15.4 x 15 x 5mm  
(0.61" x 0.59" x 0.19")

666561406912

## CONTROLLERS (Sold Separately)



**Model:** SR-2819S (R3)

**SKU:** 666561430863

**Compatible Receivers:**

- |                           |          |                          |
|---------------------------|----------|--------------------------|
| • SR-1009EA-5C (R-25.5A)  | 300-900W | <b>SKU:</b> 666561430818 |
| • SR-1009TYWi-5C (R-4A)   | 300-900W | <b>SKU:</b> 666561430788 |
| • SR-1009EATYWi-5C (R-8A) | 96-192W  | <b>SKU:</b> 666561430795 |



**Model:** VBD-MI-4Z-B3

**SKU:** 666561412913

**Compatible Receivers:**

- |                 |                          |
|-----------------|--------------------------|
| • VBD-MI-FUT037 | <b>SKU:</b> 666561412869 |
| • VBD-MI-FUT038 | <b>SKU:</b> 666561425180 |

**Disclaimer:**

The data and information contained in this specification sheet are subject to change without notice; the ratings supplied are provided based on the product manufacturer. The information contained in this specification sheet should not be considered a warranty, expressed or implied, including, but not limited to, a warranty of merchantability or fitness for a particular purpose. In no event shall Veroboard be liable for any incidental or consequential damages resulting from the use, misuse, or inability to use the product. This exclusion applies regardless of whether such damages are sought based on breach of warranty, breach of contract, negligence, strict liability in tort, or any other legal theory.

To see all available controllers and remote controls, please scan the QR code with your smartphone.



## CUSTOM ORDERING GUIDE ✂

**Single Run (Straight Run):** The below ordering guide will be used for single run LED strip.

- **PFL:** Power Feed Length
- **SL:** Strip Length

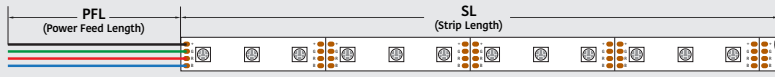

Example: 2 (QTY) x 36" (PFL) - 84" (SL)  x  -

## CUSTOM ORDERING GUIDE ✂

**Joiner:** LED strip lights need joiners if they are used for curve applications such as corner side, behind a mirror, etc.

- **PFL:** Power Feed Length
- **SL:** Strip Length
- **JL:** Joiner Length

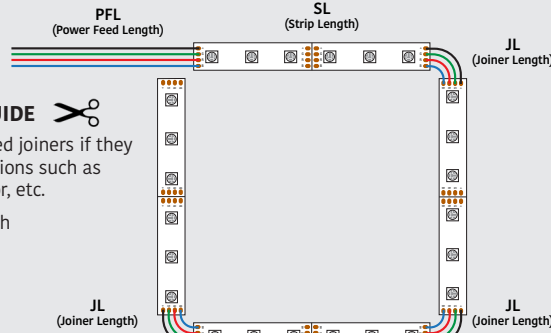

x  -  -  -  -  -  -  -

Example: 1 (QTY) x 12" (PFL) - 46" (SL) - 1" (JL) - 36" (SL) - 1" (JL) - 46" (SL) - 1" (JL) - 36" (SL)

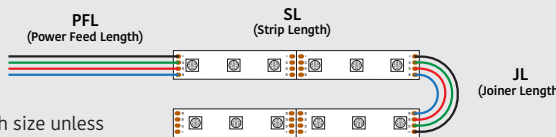

**Note:** Joiners will be 1-inch size unless customers require a specific size.

x  -  -  -

Example: 2 (QTY) x 24" (PFL) - 52" (SL) - 1" (JL) - 52" (SL)

## RECOMMENDED LED ALUMINUM CHANNELS

(Sold Separately)

<b>VBD-CH-S4</b>  <b>SKU: 666561423278</b>	<b>VBD-CH-S4B</b>  <b>SKU: 666561423285</b>	<b>VBD-CH-S6</b>  <b>SKU: 666561423315</b>			
<b>VBD-CH-S5</b>  <b>SKU: 666561423292</b>	<b>VBD-CH-S5B</b>  <b>SKU: 666561423308</b>	<b>VBD-CH-B1</b>  <b>SKU: 666561423360</b>			
<b>VBD-CH-C2</b>  <b>SKU: 666561423506</b>	<b>VBD-CH-C2B</b>  <b>SKU: 666561423513</b>	<b>VBD-CH-RF4</b>  <b>SKU: 666561423377</b>			
<b>VBD-CH-RF1</b>  <b>SKU: 666561423339</b>	<b>VBD-CH-RF1B</b>  <b>SKU: 666561423346</b>	<b>VBD-CH-C1</b>  <b>SKU: 666561423490</b>			
<b>VBD-CH-C3</b>  <b>SKU: 666561423520</b>	<b>VBD-CH-C3B</b>  <b>SKU: 666561423537</b>	<b>VBD-CH-W1</b>  <b>SKU: 666561423445</b>			
<b>VBD-CH-RF7</b>  <b>SKU: 666561423407</b>	<b>VBD-CH-RF8</b>  <b>SKU: 666561423414</b>	<b>VBD-CH-S2</b>  <b>SKU: 666561423254</b>	<b>VBD-CH-C4</b>  <b>SKU: 666561423544</b>	<b>VBD-CH-C4B</b>  <b>SKU: 666561423551</b>	<b>VBD-CH-D10</b>  <b>SKU: 666561420023</b>
<b>VBD-CH-WC4</b>  <b>SKU: 666561423629</b>	<b>VBD-CH-WC5</b>  <b>SKU: 666561423636</b>	<b>VBD-CH-ST2</b>  <b>SKU: 666561423582</b>	<b>VBD-CH-RF2</b>  <b>SKU: 666561423353</b>	<b>VBD-CH-RF3</b>  <b>SKU: 666561423360</b>	
<b>VBD-CH-S3</b>  <b>SKU: 666561423261</b>	<b>VBD-CH-RF6</b>  <b>SKU: 666561423391</b>	<b>VBD-CH-RF5</b>  <b>SKU: 666561423384</b>	<b>VBD-CH-R2</b>  <b>SKU: 666561423742</b>	<b>VBD-CH-R2B</b>  <b>SKU: 666561428280</b>	

For more information about our products and services, please visit our website: [www.veroboard.com](http://www.veroboard.com)

<b>VBD-CH-WC1</b>  SKU: 666561423599	<b>VBD-CH-WC2</b>  SKU: 666561423605	<b>VBD-CH-WC3</b>  SKU: 666561423612	<b>VBD-CH-S1</b>  SKU: 666561423247	<b>VBD-CH-R3</b>  SKU: 666561423759	<b>VBD-CH-RF10</b>  SKU: 666561423438
<b>VBD-CH-S55</b>  SKU: 666561429966	<b>VBD-CH-S55B</b>  SKU: 666561429973	<b>VBD-CH-C5</b>  SKU: 666561423568	<b>VBD-CH-R1</b>  SKU: 666561423735	<b>VBD-CH-D1</b>  SKU: 666561423643	<b>VBD-CH-D5</b>  SKU: 666561423681
<b>VBD-CH-RS5</b>  SKU: 666561428631	<b>VBD-CH-RS5B</b>  SKU: 666561428648	<b>VBD-CH-D7</b>  SKU: 666561423704	<b>VBD-CH-D8</b>  SKU: 666561423711	<b>VBD-CH-D9</b>  SKU: 666561423728	
<b>VBD-CH-M1</b>  SKU: 666561423773	<b>VBD-CH-M1B</b>  SKU: 666561431013	<b>VBD-CH-E1</b>  SKU: 666561423483	<b>Note:</b> To avoid a dark spot on the sides of these channels (RF10, RF6, RF8, R3, S1, R3) we recommend installing more than one Run LED Strip. For more details please contact us at: <a href="mailto:sales@veroboard.com">sales@veroboard.com</a>		

## RECOMMENDED LED POWER SUPPLIES (Sold Separately)

For more options and varieties, please visit our website: [www.veroboard.com](http://www.veroboard.com)

### Constant Voltage Dimmable LED Drivers (5 in 1), Triac/Phase, 0-10V, 1-10V, Potentiometer, 10V PWM 5 in 1 Dimming



Model No.	Input Voltage	Output Voltage	Wattage	IP Rating	Class	Max. Strip Length	SKU#
VBD-012-030C2DM5i1	100-277V	12V	30W	IP67	Class 2	5.3ft	666561425999
VBD-012-060C2DM5i1	100-277V	12V	60W	IP67	Class 2	10.6ft	666561426002
VBD-012-100C2DM5i1	100-277V	12V	100W	IP65	Type HL	17.7ft	666561428426
VBD-012-150C2DM5i1	100-277V	12V	150W	IP65	Type HL	26.6ft	666561428433
VBD-012-180C2DM5i1	100-277V	12V	180W (3x60W)	IP67	Class 2	32ft	666561426019
VBD-012-300C2DM5i1	100-277V	12V	300W (5x60W)	IP67	Class 2	53.3ft	666561426026

### Constant Voltage Triac LED Drivers forward Phase, Magnetic Low Voltage & Triac Dimmers



Model No.	Input Voltage	Output Voltage	Wattage	IP Rating	Class	Max. Strip Length	SKU#
VBD-012-024DM	100-130V	12V	24W	IP20	Class 2	4.2ft	666561415761
VBD-012-048DM	100-130V	12V	48W	IP20	Class 2	8.6ft	666561415754
VBD-012-060DM	100-130V	12V	60W	IP20	Class 2	10.6ft	666561415747
VBD-012-096DM	100-130V	12V	96W	IP67	-	17ft	666561415730
VBD-012-150DM	100-130V	12V	150W	IP67	-	26.6ft	666561415723
VBD-012-200DM	100-130V	12V	200W	IP67	-	35.5ft	666561415716
VBD-012-300VTHWJ	100-277V	12V	300W	IP65	-	53.3ft	666561419790

For more information about our products and services, please visit our website: [www.veroboard.com](http://www.veroboard.com)

**DALI DIMMING CONSTANT VOLTAGE**



Model No.	Input Voltage	Output Voltage	Wattage	IP Rating	Class	Max. Strip Length	SKU#
VBD-012-030DD	100-265V AC	12V	30W	IP20	Class 2	5.3ft	666561427290
VBD-012-060DD	100-265V AC	12V	60W	IP65	Class 2	10.6ft	666561427313
VBD-012-096DD	100-265V AC	12V	96W	IP65	-----	17ft	666561427337
VBD-012-150DD	100-265V AC	12V	150W	IP65	-----	26.6ft	666561427351

**PLUG-IN DRIVERS**



Model No.	Input Voltage	Output Voltage	Wattage	IP Rating	Class	Max. Strip Length	SKU#
VBDA-012-012P1J	100-240V AC	12V	12W	IP20	Class 2	2.1ft	666561428945
VBDA-012-024P1J	100-240V AC	12V	24W	IP20	Class 2	4.2ft	666561428952
VBDA-012-036P1J	100-240V AC	12V	36W	IP20	Class 2	6.4ft	666561428976
VBDA-012-060P1J	100-240V AC	12V	60W	IP20	-----	10.6ft	666561428990

**Notes:** \_\_\_\_\_  
 \_\_\_\_\_  
 \_\_\_\_\_  
 \_\_\_\_\_  
 \_\_\_\_\_  
 \_\_\_\_\_  
 \_\_\_\_\_  
 \_\_\_\_\_  
 \_\_\_\_\_  
 \_\_\_\_\_  
 \_\_\_\_\_

**Disclaimer:**  
 The data and information contained in this specification sheet are subject to change without notice; the ratings supplied are provided based on the product manufacturer. The information contained in this specification sheet should not be considered a warranty, expressed or implied, including, but not limited to, a warranty of merchantability or fitness for a particular purpose. In no event shall Veroboard be liable for any incidental or consequential damages resulting from the use, misuse, or inability to use the product. This exclusion applies regardless of whether such damages are sought based on breach of warranty, breach of contract, negligence, strict liability in tort, or any other legal theory.

For more information about our products and services, please visit our website: [www.veroboard.com](http://www.veroboard.com)

# Light Measurement Report

Print date: 2023-04-26

Measurement date and time: 2023-04-26 1:41:38 PM – Measurement no. VFR-230426-0171-MS

## Luminous Intensity diagram

Unit: 0-100% of peak intensity

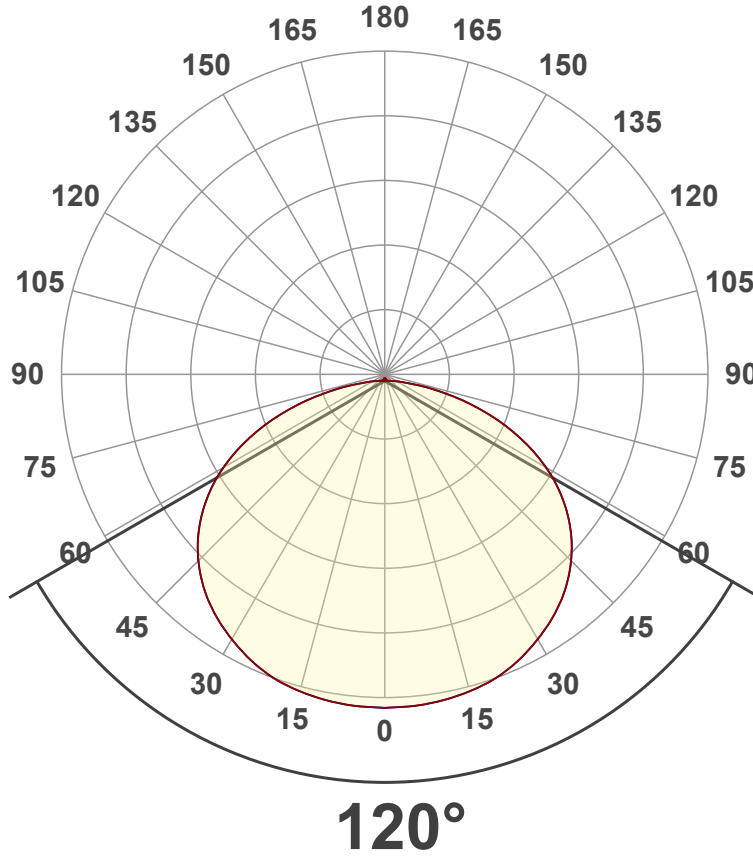

## Main Values

Lumen Up% / Down%	0.99% / 99.01%
Peak Intensity	25.4 cd
Beam Angle (50%)	120°
Beam Angle (90%)	130.9°
Beam Angle (10%)	130.9°

## Cut-off Angle

Average 2,5%	179.2°
--------------	--------

## Field Angle

Average 10%	166.5°
-------------	--------

## Intensity Ratio

In 120° cone	74.1%
In 90° cone	47.7%

**C000-C180**  
**C090-C270**

## Linear distribution diagram - Intensity (candela) vs $\gamma$ -angle

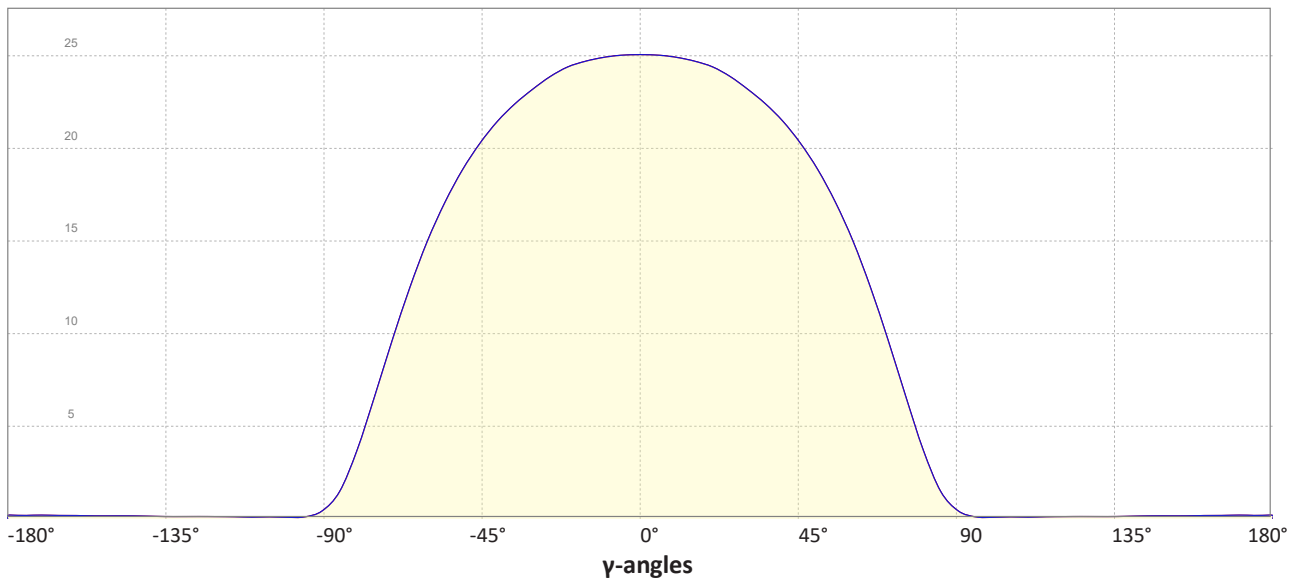



# Light Measurement Report

Print date: 2023-04-26

Measurement date and time: 2023-04-26 1:41:38 PM – Measurement no. VFR-230426-0171-MS

## Beam Details

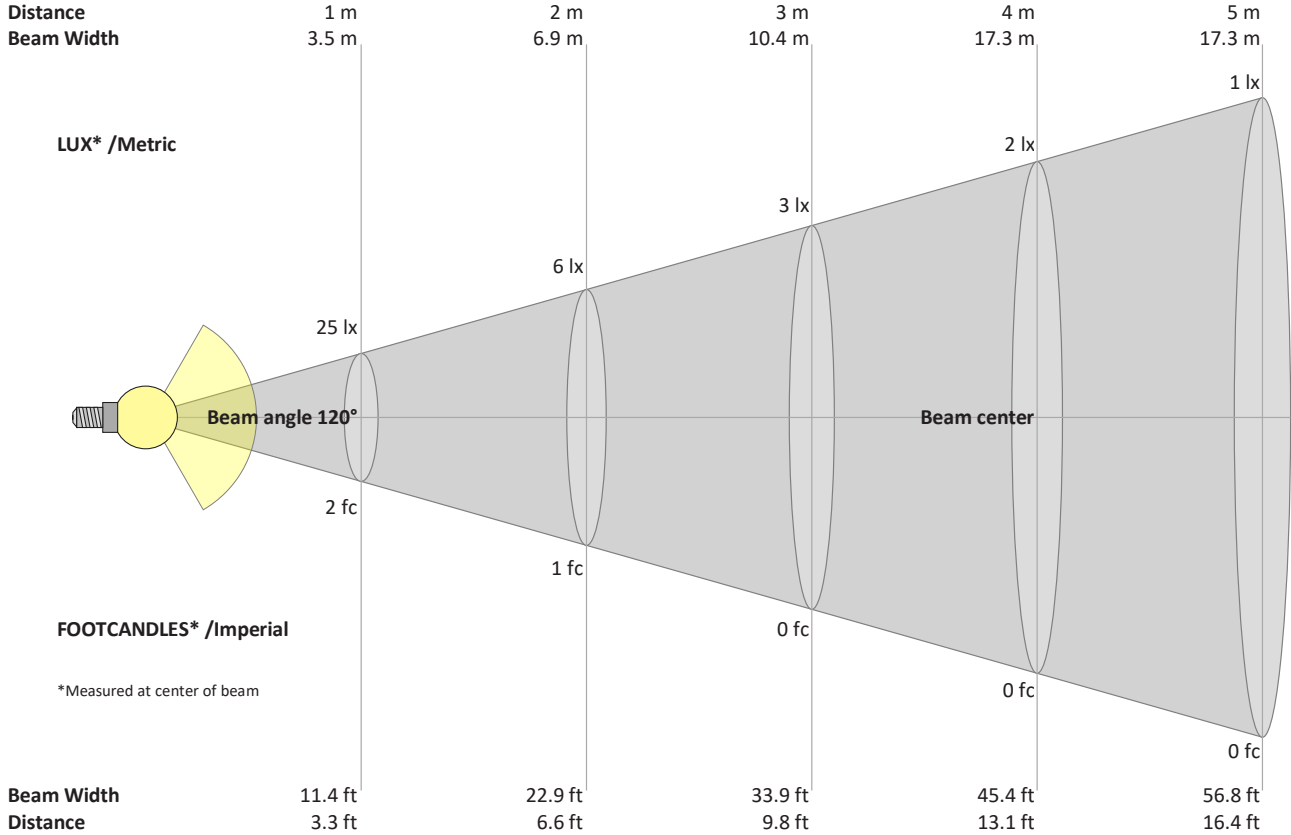

### Beam intensities from 1 – 20 m

1	2	3	4	5	6	7	8	9	10	11	12	13	14	15	16	17	18	19	20	m	
3.3	6.6	9.8	13.1	16.4	19.7	23	26.2	29.5	32.8	36.1	39.4	42.7	45.9	49.2	52.5	55.8	59.1	62.3	65.6	ft	
25	6	3	2	1	1	1	0	0	0	0	0	0	0	0	0	0	0	0	0	0	lux
2.4	0.6	0.3	0.1	0.1	0.1	0	0	0	0	0	0	0	0	0	0	0	0	0	0	0	fc

### Intensities in 0° c-plane

0°	5°	10°	15°	20°	25°	30°	35°	40°	45°	50°	55°	60°	65°	70°	75°	80°	85°	90°	95°	y
25.4	25.4	25.3	25.1	24.8	24.3	23.6	22.9	21.9	20.7	19.3	17.6	15.5	13.0	10.1	7.1	4.1	1.7	0.5	0.1	cd
100%	100%	99%	99%	98%	96%	93%	90%	86%	81%	76%	69%	61%	51%	40%	28%	16%	7%	2%	1%	of 0°val

### Intensities in 90° c-plane

0°	5°	10°	15°	20°	25°	30°	35°	40°	45°	50°	55°	60°	65°	70°	75°	80°	85°	90°	95°	y
25.4	25.4	25.3	25.1	24.8	24.3	23.6	22.9	21.9	20.7	19.3	17.6	15.5	13.0	10.1	7.1	4.1	1.7	0.5	0.1	cd
100%	100%	99%	99%	98%	96%	93%	90%	86%	81%	76%	69%	61%	51%	40%	28%	16%	7%	2%	1%	of 0°val

### Intensities in 180° c-plane

0°	5°	10°	15°	20°	25°	30°	35°	40°	45°	50°	55°	60°	65°	70°	75°	80°	85°	90°	95°	y
25.4	25.4	25.3	25.1	24.8	24.3	23.6	22.9	21.9	20.7	19.3	17.6	15.5	13.0	10.1	7.1	4.1	1.7	0.5	0.1	cd
100%	100%	99%	99%	98%	96%	93%	90%	86%	81%	76%	69%	61%	51%	40%	28%	16%	7%	2%	1%	of 0°val

### Intensities in 270° c-plane

0°	5°	10°	15°	20°	25°	30°	35°	40°	45°	50°	55°	60°	65°	70°	75°	80°	85°	90°	95°	y
25.4	25.4	25.3	25.1	24.8	24.3	23.6	22.9	21.9	20.7	19.3	17.6	15.5	13.0	10.1	7.1	4.1	1.7	0.5	0.1	cd
100%	100%	99%	99%	98%	96%	93%	90%	86%	81%	76%	69%	61%	51%	40%	28%	16%	7%	2%	1%	of 0°val