

VEROBOARD®

LED Type: VBDFS-5050-RGB-60-12-NS
Colour: RGB

Contact Name: _____

Company: _____

Phone: _____

Email: _____



DESCRIPTION

Flexible 12 mm wide linear LED strip. Available in 5 meter (196.8 inches) rolls that can be cut every 3 LEDs (50.8 mm or 2 in). The LED Strip lights are manufactured with high-quality materials and designed for professional lighting. Every strip light begins with a heavy-duty dual-core copper printed circuit board (PC Board), it is then soldered with an array of chips and color options. They can be cut to any size (marked interval points) and rejoined by soldering.

	Wattage
Per Foot	4.5W/ft
Per Meter	15W/m



666561409562

DIMENSIONS

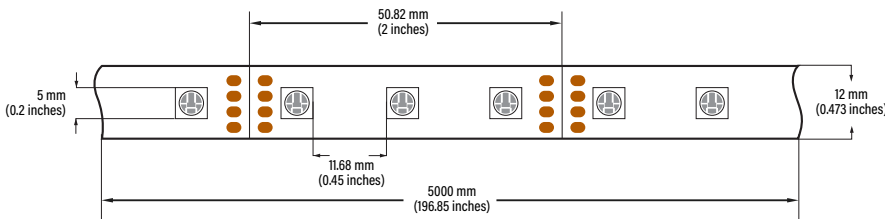

SPECIFICATIONS

Model:	VBDFS-5050-RGB-60-12-NS
Color Temperature:	RGB
LED Type:	5050 SMD
LED Qty:	60 LEDs per meter
Input Voltage (VF):	12V DC
Power:	15W per meter (4.5W/ft)
Brightness:	2600-3000 MCD
Lifespan:	>50,000 hours
PCB:	4oz PCB, Double-side, white colour 12mm width
IP Rating:	IP20 (Indoor use only)
Rendering Index (Ra):	CRI>95
Beam Angle:	120°
Dimmable:	Yes
Cut Size:	Every 3 LED chips (2")
Operating Temperature:	-15°C to +40°C
Dimensions:	5,000 x 12 x 2.15mm (196.8" x 0.47" x 0.08")
Certificates:	UL / RoHs
Roll Length:	5 meter roll (16.4ft)

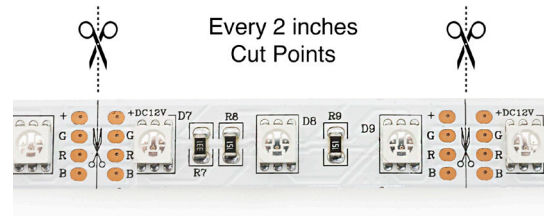

ORDERING GUIDE

Example part number: **VBDFS - 5050 - RGB - 60 - 12 - NS**

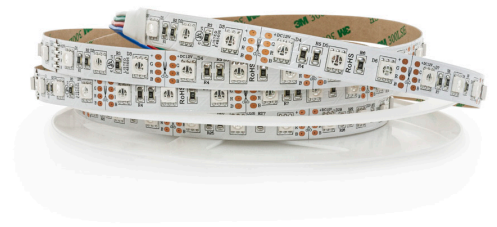
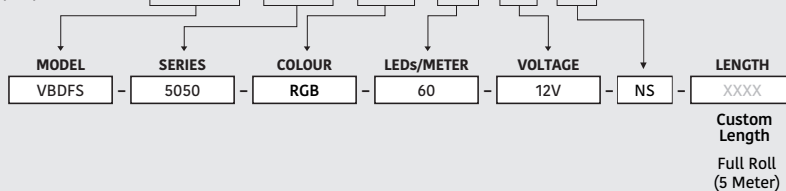

For more information about our products and services, please visit our website: www.veroboard.com

CONNECTORS (Sold Separately)

Note: Connectors fit in some aluminum channels only.

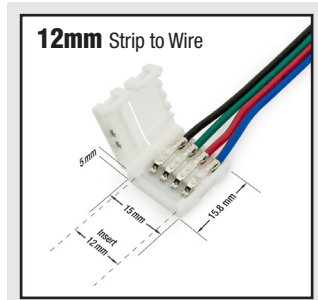

MODEL:

VBD-RGBCON-12MM-1S1W

Material: Plastic

Strip Light Width: 12mm

Package Content: LED Strip to Wire Connector (Pack of 1)

Dimensions: 15.8 x 15 x 5mm
(0.62" x 0.59" x 0.19")

666561406967

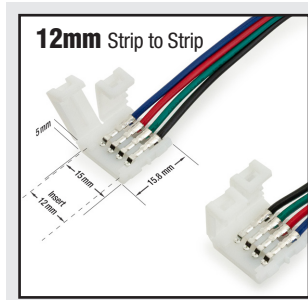

MODEL:

VBD-RGBCON-12MM-CRNR

Material: Plastic

Strip Light Width: 12mm

Package Content: LED Strip to Strip Connector (Pack of 1)

Dimensions: 15.8 x 15 x 5mm
(0.62" x 0.59" x 0.19")

666561406776

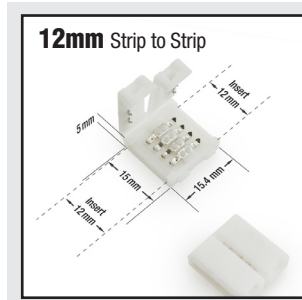

MODEL:

VBD-RGBCON-12MM-2S

Material: Plastic

Strip Light Width: 12mm

Package Content: LED Strip to Strip Connector (Pack of 1)

Dimensions: 15.4 x 15 x 5mm
(0.61" x 0.59" x 0.19")

666561406912

CONTROLLERS (Sold Separately)



Model: SR-2819S (R3)

SKU: 666561430863

Compatible Receivers:

- | | | |
|---------------------------|----------|--------------------------|
| • SR-1009EA-5C (R-25.5A) | 300-900W | SKU: 666561430818 |
| • SR-1009TYWi-5C (R-4A) | 300-900W | SKU: 666561430788 |
| • SR-1009EATYWi-5C (R-8A) | 96-192W | SKU: 666561430795 |

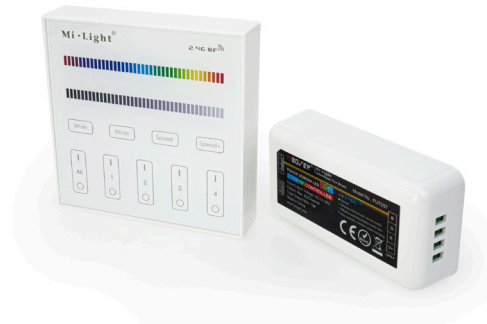

Model: VBD-MI-4Z-B3

SKU: 666561412913

Compatible Receivers:

- | | |
|-----------------|--------------------------|
| • VBD-MI-FUT037 | SKU: 666561412869 |
| • VBD-MI-FUT038 | SKU: 666561425180 |

To see all available controllers and remote controls, please scan the QR code with your smartphone.



Disclaimer:

The data and information contained in this specification sheet are subject to change without notice; the ratings supplied are provided based on the product manufacturer. The information contained in this specification sheet should not be considered a warranty, expressed or implied, including, but not limited to, a warranty of merchantability or fitness for a particular purpose. In no event shall Veroboard be liable for any incidental or consequential damages resulting from the use, misuse, or inability to use the product. This exclusion applies regardless of whether such damages are sought based on breach of warranty, breach of contract, negligence, strict liability in tort, or any other legal theory.

Light Measurement Report

Print date: 2023-04-26

Measurement date and time: 2023-04-26 1:41:38 PM – Measurement no. VFR-230426-0171-MS

Luminous Intensity diagram

Unit: 0-100% of peak intensity

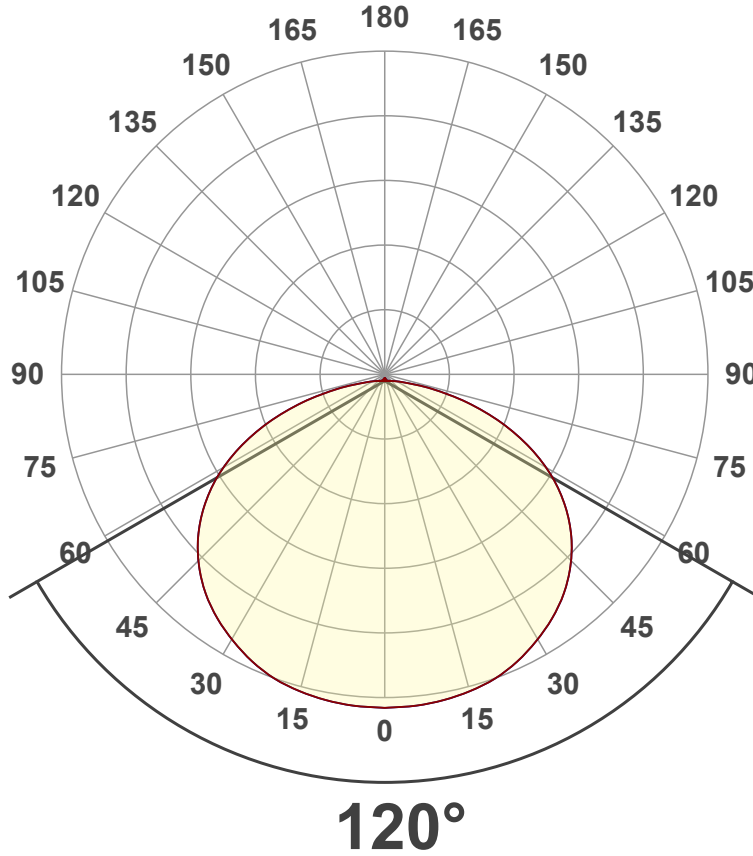

Main Values

Lumen Up% / Down%	0.99% / 99.01%
Peak Intensity	25.4 cd
Beam Angle (50%)	120°
Beam Angle (90%)	130.9°
Beam Angle (10%)	130.9°

Cut-off Angle

Average 2,5%	179.2°
--------------	--------

Field Angle

Average 10%	166.5°
-------------	--------

Intensity Ratio

In 120° cone	74.1%
In 90° cone	47.7%

C000-C180
C090-C270

Linear distribution diagram - Intensity (candela) vs γ -angle

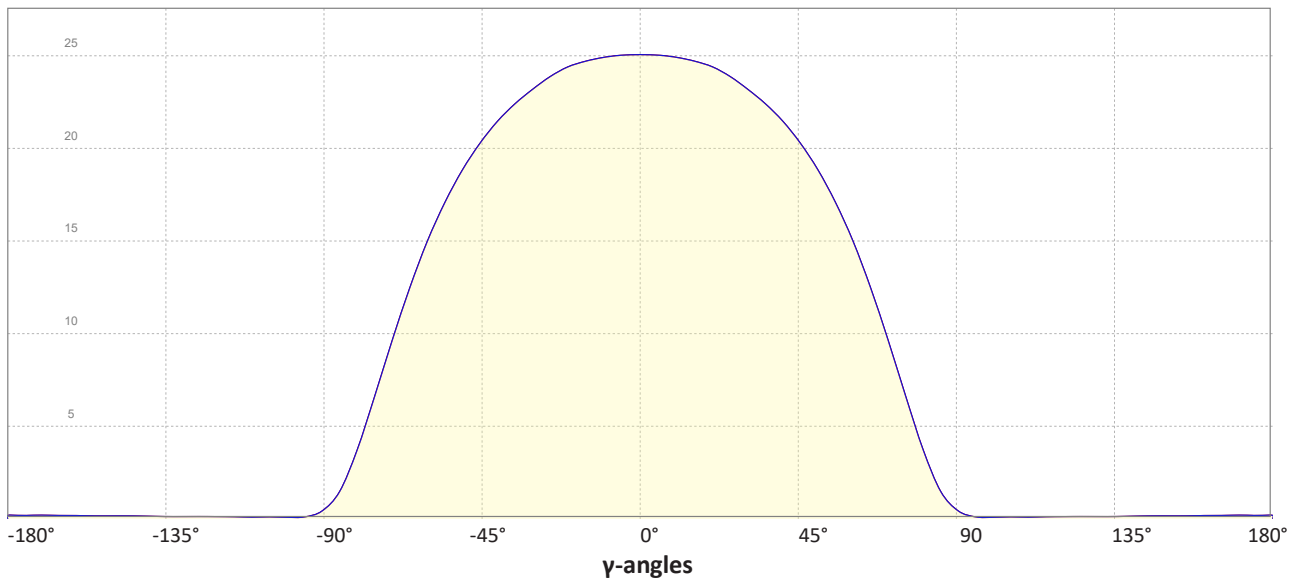

Light Measurement Report

Print date: 2023-04-26

Measurement date and time: 2023-04-26 1:41:38 PM – Measurement no. VFR-230426-0171-MS

Beam Details

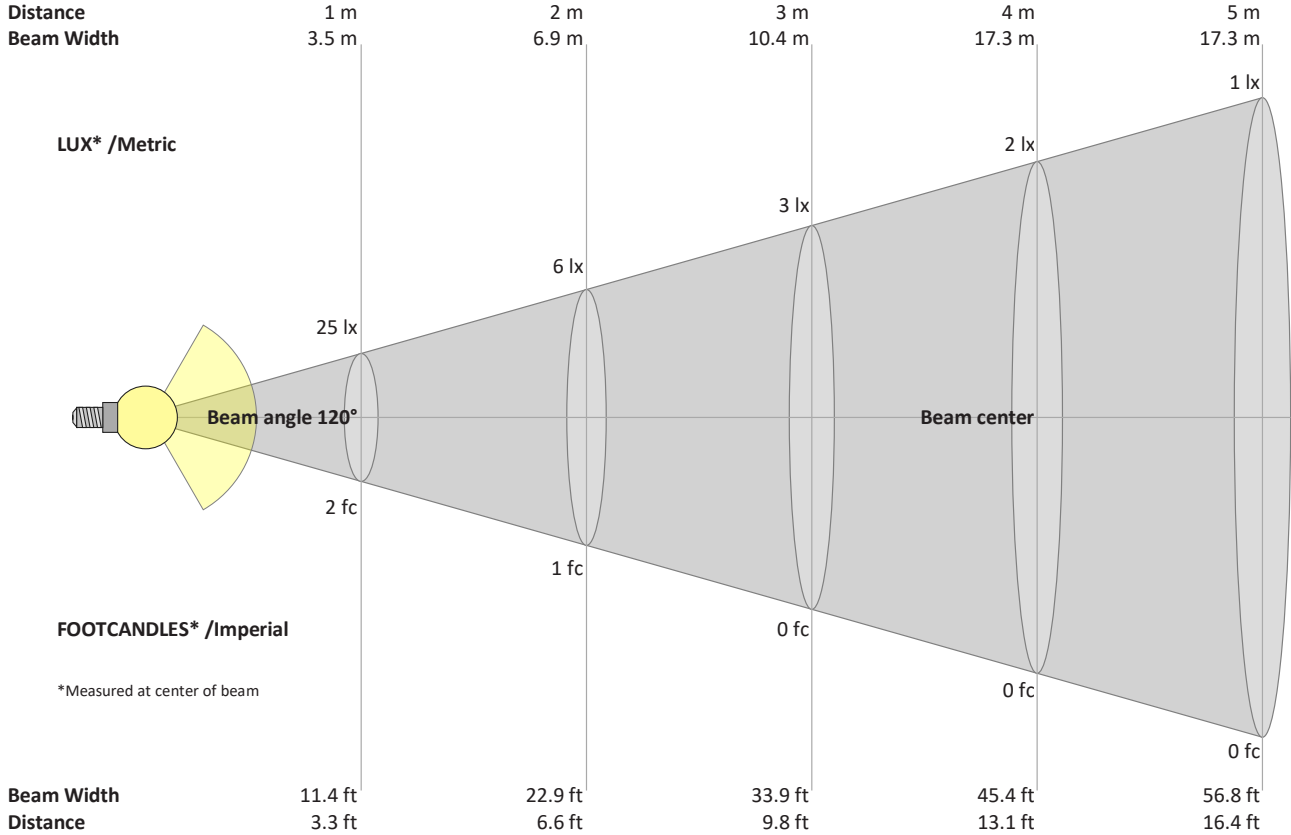

Beam intensities from 1 – 20 m

1	2	3	4	5	6	7	8	9	10	11	12	13	14	15	16	17	18	19	20	m	
3.3	6.6	9.8	13.1	16.4	19.7	23	26.2	29.5	32.8	36.1	39.4	42.7	45.9	49.2	52.5	55.8	59.1	62.3	65.6	ft	
25	6	3	2	1	1	1	0	0	0	0	0	0	0	0	0	0	0	0	0	0	lux
2.4	0.6	0.3	0.1	0.1	0.1	0	0	0	0	0	0	0	0	0	0	0	0	0	0	0	fc

Intensities in 0° c-plane

0°	5°	10°	15°	20°	25°	30°	35°	40°	45°	50°	55°	60°	65°	70°	75°	80°	85°	90°	95°	y
25.4	25.4	25.3	25.1	24.8	24.3	23.6	22.9	21.9	20.7	19.3	17.6	15.5	13.0	10.1	7.1	4.1	1.7	0.5	0.1	cd
100%	100%	99%	99%	98%	96%	93%	90%	86%	81%	76%	69%	61%	51%	40%	28%	16%	7%	2%	1%	of 0°val

Intensities in 90° c-plane

0°	5°	10°	15°	20°	25°	30°	35°	40°	45°	50°	55°	60°	65°	70°	75°	80°	85°	90°	95°	y
25.4	25.4	25.3	25.1	24.8	24.3	23.6	22.9	21.9	20.7	19.3	17.6	15.5	13.0	10.1	7.1	4.1	1.7	0.5	0.1	cd
100%	100%	99%	99%	98%	96%	93%	90%	86%	81%	76%	69%	61%	51%	40%	28%	16%	7%	2%	1%	of 0°val

Intensities in 180° c-plane

0°	5°	10°	15°	20°	25°	30°	35°	40°	45°	50°	55°	60°	65°	70°	75°	80°	85°	90°	95°	y
25.4	25.4	25.3	25.1	24.8	24.3	23.6	22.9	21.9	20.7	19.3	17.6	15.5	13.0	10.1	7.1	4.1	1.7	0.5	0.1	cd
100%	100%	99%	99%	98%	96%	93%	90%	86%	81%	76%	69%	61%	51%	40%	28%	16%	7%	2%	1%	of 0°val

Intensities in 270° c-plane

0°	5°	10°	15°	20°	25°	30°	35°	40°	45°	50°	55°	60°	65°	70°	75°	80°	85°	90°	95°	y
25.4	25.4	25.3	25.1	24.8	24.3	23.6	22.9	21.9	20.7	19.3	17.6	15.5	13.0	10.1	7.1	4.1	1.7	0.5	0.1	cd
100%	100%	99%	99%	98%	96%	93%	90%	86%	81%	76%	69%	61%	51%	40%	28%	16%	7%	2%	1%	of 0°val

CUSTOM ORDERING GUIDE ✂

Single Run (Straight Run): The below ordering guide will be used for single run LED strip.

- **PFL:** Power Feed Length
- **SL:** Strip Length

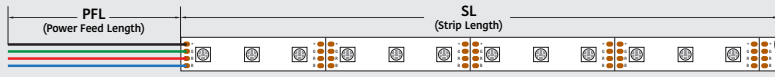

Example: 2 (QTY) x 36" (PFL) - 84" (SL) x -

CUSTOM ORDERING GUIDE ✂

Joiner: LED strip lights need joiners if they are used for curve applications such as corner side, behind a mirror, etc.

- **PFL:** Power Feed Length
- **SL:** Strip Length
- **JL:** Joiner Length

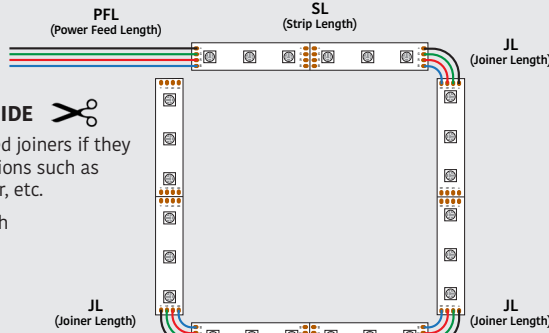

x - - - - - - -

Example: 1 (QTY) x 12" (PFL) - 46" (SL) - 1" (JL) - 36" (SL) - 1" (JL) - 46" (SL) - 1" (JL) - 36" (SL)

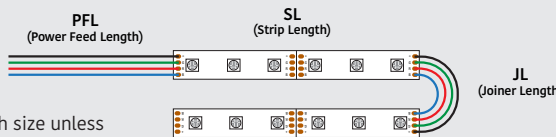

Note: Joiners will be 1-inch size unless customers require a specific size.

x - - -

Example: 2 (QTY) x 24" (PFL) - 52" (SL) - 1" (JL) - 52" (SL)

RECOMMENDED LED ALUMINUM CHANNELS

(Sold Separately)

VBD-CH-S4 SKU: 666561423278	VBD-CH-S4B SKU: 666561423285	VBD-CH-S6 SKU: 666561423315			
VBD-CH-S5 SKU: 666561423292	VBD-CH-S5B SKU: 666561423308	VBD-CH-B1 SKU: 666561423360			
VBD-CH-C2 SKU: 666561423506	VBD-CH-C2B SKU: 666561423513	VBD-CH-RF4 SKU: 666561423377			
VBD-CH-RF1 SKU: 666561423339	VBD-CH-RF1B SKU: 666561423346	VBD-CH-C1 SKU: 666561423490			
VBD-CH-C3 SKU: 666561423520	VBD-CH-C3B SKU: 666561423537	VBD-CH-W1 SKU: 666561423445			
VBD-CH-RF7 SKU: 666561423407	VBD-CH-RF8 SKU: 666561423414	VBD-CH-S2 SKU: 666561423254	VBD-CH-C4 SKU: 666561423544	VBD-CH-C4B SKU: 666561423551	VBD-CH-D10 SKU: 666561420023
VBD-CH-WC4 SKU: 666561423629	VBD-CH-WC5 SKU: 666561423636	VBD-CH-ST2 SKU: 666561423582	VBD-CH-RF2 SKU: 666561423353	VBD-CH-RF3 SKU: 666561423360	
VBD-CH-S3 SKU: 666561423261	VBD-CH-RF6 SKU: 666561423391	VBD-CH-RF5 SKU: 666561423384	VBD-CH-R2 SKU: 666561423742	VBD-CH-R2B SKU: 666561428280	

For more information about our products and services, please visit our website: www.veroboard.com

VBD-CH-WC1 SKU: 666561423599	VBD-CH-WC2 SKU: 666561423605	VBD-CH-WC3 SKU: 666561423612	VBD-CH-S1 SKU: 666561423247	VBD-CH-R3 SKU: 666561423759	VBD-CH-RF10 SKU: 666561423438
VBD-CH-S55 SKU: 666561429966	VBD-CH-S55B SKU: 666561429973	VBD-CH-C5 SKU: 666561423568	VBD-CH-R1 SKU: 666561423735	VBD-CH-D1 SKU: 666561423643	VBD-CH-D5 SKU: 666561423681
VBD-CH-RS5 SKU: 666561428631	VBD-CH-RS5B SKU: 666561428648	VBD-CH-D7 SKU: 666561423704	VBD-CH-D8 SKU: 666561423711	VBD-CH-D9 SKU: 666561423728	
VBD-CH-M1 SKU: 666561423773	VBD-CH-M1B SKU: 666561431013	VBD-CH-E1 SKU: 666561423483	Note: To avoid a dark spot on the sides of these channels (RF10, RF6, RF8, R3, S1, R3) we recommend installing more than one Run LED Strip. For more details please contact us at: sales@veroboard.com		

RECOMMENDED LED POWER SUPPLIES (Sold Separately)

For more options and varieties, please visit our website: www.veroboard.com

Constant Voltage Dimmable LED Drivers (5 in 1), Triac/Phase, 0-10V, 1-10V, Potentiometer, 10V PWM 5 in 1 Dimming



Model No.	Input Voltage	Output Voltage	Wattage	IP Rating	Class	Max. Strip Length	SKU#
VBD-012-030C2DM5i1	100-277V	12V	30W	IP67	Class 2	5.3ft	666561425999
VBD-012-060C2DM5i1	100-277V	12V	60W	IP67	Class 2	10.6ft	666561426002
VBD-012-100C2DM5i1	100-277V	12V	100W	IP65	Type HL	17.7ft	666561428426
VBD-012-150C2DM5i1	100-277V	12V	150W	IP65	Type HL	26.6ft	666561428433
VBD-012-180C2DM5i1	100-277V	12V	180W (3x60W)	IP67	Class 2	32ft	666561426019
VBD-012-300C2DM5i1	100-277V	12V	300W (5x60W)	IP67	Class 2	53.3ft	666561426026

Constant Voltage Triac LED Drivers forward Phase, Magnetic Low Voltage & Triac Dimmers



Model No.	Input Voltage	Output Voltage	Wattage	IP Rating	Class	Max. Strip Length	SKU#
VBD-012-024DM	100-130V	12V	24W	IP20	Class 2	4.2ft	666561415761
VBD-012-048DM	100-130V	12V	48W	IP20	Class 2	8.6ft	666561415754
VBD-012-060DM	100-130V	12V	60W	IP20	Class 2	10.6ft	666561415747
VBD-012-096DM	100-130V	12V	96W	IP67	-	17ft	666561415730
VBD-012-150DM	100-130V	12V	150W	IP67	-	26.6ft	666561415723
VBD-012-200DM	100-130V	12V	200W	IP67	-	35.5ft	666561415716
VBD-012-300VTHWJ	100-277V	12V	300W	IP65	-	53.3ft	666561419790

For more information about our products and services, please visit our website: www.veroboard.com

